

LANDA[®]
Kärcher Group



Pressure Washer

Parts & Accessories



All Prices in U.S. Dollars – Effective January 1, 2016



NOTE: There are many parts and accessories we sell which are not included in the catalog. Should you need an item or part not included in the catalog, call your customer service representative and chances are we will have it in stock or can get it for you. We are a full-service supplier for the vendors represented in this catalog.

ACCESSORIES AND PARTS

- Our Focus Items 2-9

PRESSURE WASHER PARTS

- Guns & Lances 10-19
- Hose & Hose Reels 20-28
- Couplers, Fittings & Filters 29-41
- Nozzles 42-54
- Pumps & Pump Kits 55-79
- Unloaders, Valves, Injectors & Gauges 80-96
- Engines, Motors & Parts 97-103
- Burners 104-111
- Electrical Components 112-120
- Chassis Components 121-122
- Pressure Washer Accessories 123-133

- CAR WASH BAY ACCESSORIES 134-141**

- AG SPRAY ACCESSORIES 142-146**

- CARPET & RESTORATION 147-172**

- Sprayers and Parts 147-148
- Equipment 148
- Tile and Hard Surface Tools 149
- Van Accessories 149
- Restoration Equipment and Accessories 150-154
- Carpet Installation and Repair 155-158
- Hoses, Connectors and Accessories 158-162
- Brushes 163
- Groomers 163-164
- Containers 164-165
- Misc. Accessories 165-166
- Safety Items 167-168
- Wands and Upholstery Tools 169-170
- Window Washing Tools 170-172

- INDEX 173-184

What's in a name?

Legacy

Highest Quality, Strength, Longevity and Innovation.

Legacy, from Spraymart, has the widest selection of premium pressure washer parts and accessories available. Offering innovation, superior workmanship, excellent quality and yet price competitive.

You'll find Legacy throughout our catalog in the following sections:

- Pumps
- Guns
- Hoses
- Couplers
- Filters
- Nozzles
- Accessories
- Detergents

Legacy "Best" Spray Gun

Ergonomically designed to be the most comfortable gun on the market.



- **PSI: 5000**
- **GPM: 12**
- **Temperature: 300°F**
- 3/8" FPT inlet x 1/4" FPT outlet
- Weight: 21 oz
- Ideal for commercial cleaning and long work time applications

Part #	Description	List Price
8.751-213.0	"Best" Spray Gun	\$49.39
8.701-673.0	Unitized Valve Kit	\$14.65



Legacy Superlite Stainless-Steel Dual Lance

Superlite stainless-steel with nozzle guard.



Dual Lance w/ Nozzle Guard

- **PSI: 4000**
- **Temperature: 200°F**
- Side handle / valve actuator
- Viton seal
- Forged brass valve body
- 1/4" MPT inlet
- 1/8" stainless-steel outlet tubing

Part #	Old No.	Description	List Price
8.710-618.0	368160	36" – 37.8 oz	\$83.79
8.710-620.0	368165	72" – 56.0 oz	\$106.61



Legacy "Industrial" Spray Gun

Featuring a comfortable grip to reduce user fatigue.



- **PSI: 5000**
- **GPM: 10.4**
- **Temperature: 300°F**
- 3/8" FPT inlet x 1/4" FPT outlet
- Weight: 19.84 oz
- Ideal for various industrial cleaning applications

Part #	Description	List Price
8.751-214.0	"Industrial" Spray Gun	\$37.90
8.751-119.0	Valve Kit	\$19.61



Legacy Rawhide 2-Wire 3/8" Hose



Part #	Old No.	Length	Working Temp	Approx wt lbs	List Price
3/8" Black Hose (6000 PSI) – Wrapped					
8.739-078.0	159580	50'	275°F	17.0	\$116.58
3/8" Blue Hose (4500 PSI) – Smooth					
8.739-229.0	154415	50'	250°F	17.0	\$179.66
8.739-231.0	154425	100'	250°F	33.0	\$307.53



Legacy Rawhide 1-Wire 4000 PSI Black Hose

- Durable wrapped finish outer cover



Part #	Old No.	Length	Temp	Working PSI	Approx wt lbs	List Price
3/8" Black Hose (wrapped)						
8.739-031.0	158280	50' x 3/8" ID	275°F	4000	12.0	\$91.85
8.739-033.0	158290	100' x 3/8" ID	275°F	4000	23.0	\$171.40



Legacy Ultima 2-Wire 5000 PSI Black Hose



- Wrapped

Part #	Old No.	Length	Temp	Working PSI	Approx wt lbs	List Price
3/8" Black Hose (5000 PSI) – Wrapped						
8.739-224.0	154250	50' x 3/8" ID	275°	5000	15.0	\$113.30
8.739-226.0	154290	100' x 3/8" ID	275°	5000	28.0	\$210.63



Legacy Quick Couplers



Legacy Brass Couplers give premium performance with economy price. Legacy Quick Connect Couplings are machined from top-grade materials to the same exacting specifications as the high-cost performance leaders. We have gone a step further to ensure that Legacy Quick Couplers can withstand high temperature, high pressure and aggressive chemicals by including EPDM o-rings as standard.
Compare the performance — compare the price!



- Precision brass design
- Stainless-steel band for increased durability (except 1/2")
- Unrestricted free-flow
- 4000 PSI max

Brass Couplers, designed for 4000 PSI and extended durability. Affordable and rugged all in one.

Part #	Old No.	Description	List Price	Case Lot Part #	Case Price
9.802-165.0	2-2001	1/4" MPT	\$4.34	8.916-542.0 Case of 200 Couplers	\$741.24
9.802-169.0	2-2003	3/8" MPT	\$5.06	8.916-541.0 Case of 200 Couplers	\$856.96
8.707-167.0	2-20181	1/2" MPT	\$20.39		



- Zinc-plated
- Hardened steel
- 4000 PSI max

Steel Nipples, hardened steel combined with zinc yellow chromate plating holds up to the harshest environments.

Part #	Old No.	Description	List Price	Case Lot Part #	Case Price
8.707-139.0	2-2005	1/4" MPT	\$1.09	8.916-540.0 Case of 200 Nipples	\$144.90
9.802-171.0	2-2007	3/8" MPT	\$1.30	8.916-539.0 Case of 200 Nipples	\$172.85
8.707-164.0	2-2017	1/2" MPT	\$6.52	8.916-536.0 Case of 200 Nipples	\$202.86

Stainless-Steel Quick Couplers



- Chemical-resistant
- 303 stainless-steel
- 6000 PSI



Part #	Old No.	Description	List Price
8.707-110.0	2-2001SS	1/4" MPT Stainless-steel Couplers	\$5.87
8.707-135.0	2-2003SS	3/8" MPT Stainless-steel Couplers	\$7.36
8.707-140.0	2-20051	1/4" MPT Stainless-steel Nipples	\$2.99
8.707-152.0	2-20071	3/8" MPT Stainless-steel Nipples	\$3.91

The Legacy Revolution Turbo Nozzle

Legacy Revolution Turbo Nozzle is rated for up to 4350 PSI at 185°F. Turning at an astounding 4000 RPM, the Revolution delivers faster and deeper cleaning action for the same price of 3000 PSI rotary nozzles.



Nozzle Part #	Old No.	Orifice	PSI	List Price
9.302-242.0	374231	3.5	4350	\$89.04
9.302-243.0	374232	4.0	4350	\$89.92
9.302-244.0	374233	4.5	4350	\$89.92
9.302-245.0	374234	5.0	4350	\$89.92
9.302-246.0	374235	5.5	4350	\$89.92
9.302-247.0	374236	6.5	4350	\$89.04
9.302-248.0	374237	7.0	4350	\$89.04
9.302-249.0	374238	12.0	4350	\$89.04

Repair Kit

2.884-972.0	079920	3.5	\$61.38
2.883-824.0	079921	4.0	\$61.38
9.302-231.0	079922	4.5	\$61.53
2.883-823.0	079923	5.0	\$61.38
2.883-822.0	079924	5.5	\$61.23
9.302-234.0	079925	6.5	\$61.53
2.884-974.0	079926	7.0	\$61.38
2.884-975.0	079927	10.0	\$61.38

Legacy 4/pk and 5/pk Color-Coded QC Nozzle Kits



1/4" Quick Coupler Nozzle Kits

- The 5-pack includes one 40 x 65° soap nozzle.

4/pk (0°, 25°, 40°, and Soap)

Part #	Nozzle Size	List Price	10+
8.726-117.0	3.0	\$16.46	\$15.57
9.104-028.0	3.25	\$16.46	\$15.57
8.726-119.0	3.5	\$16.46	\$15.57
8.726-120.0	4.0	\$16.46	\$15.57
8.726-121.0	4.5	\$16.46	\$15.57
8.726-122.0	5.0	\$16.46	\$15.57
8.726-123.0	5.5	\$16.46	\$15.57
8.726-124.0	6.0	\$16.46	\$15.57
8.726-125.0	6.5	\$16.46	\$15.57

5/pk (0°, 15°, 25°, 40°, and Soap)

Part #	Nozzle Size	List Price	10+
9.104-024.0	3.0	\$20.03	\$19.28
9.104-016.0	3.25	\$19.98	\$19.28
8.726-128.0	3.5	\$20.03	\$19.28
9.104-030.0	4.0	\$20.03	\$19.28
8.726-130.0	4.5	\$20.03	\$19.28
8.726-131.0	5.0	\$19.98	\$19.28
8.726-132.0	5.5	\$20.03	\$19.28
8.726-133.0	6.0	\$20.03	\$19.28
8.726-134.0	6.5	\$20.03	\$19.28

Legacy Individual 1/4" QC Nozzles



QC Nozzles

List Price	10+
\$4.40	\$

"QC", Color-coded, hardened stainless nozzle, fits most 1/4" quick couplers. Rated for 4000 PSI.

Orifice	0° (Red) Part No	15° (Yellow) Part No	25° (Green) Part No	40° (White) Part No
3.0	8.723-576.0	8.902-482.0	8.902-484.0	8.902-485.0
3.25	8.708-538.0	8.708-539.0	8.708-540.0	8.708-541.0
3.5	8.723-577.0	8.726-104.0	8.708-526.0	8.902-487.0
3.75	8.708-527.0	8.708-528.0	8.708-529.0	8.708-530.0
4.0	8.708-531.0	8.708-532.0	8.708-533.0	8.708-534.0
4.5	8.723-578.0	8.708-535.0	8.708-536.0	8.708-537.0
5.0	8.726-105.0	8.726-106.0	8.726-107.0	8.726-108.0
5.5	8.723-579.0	8.902-492.0	8.708-542.0	8.902-493.0
6.0	8.726-109.0	8.726-110.0	8.726-111.0	8.726-112.0
6.5	8.726-113.0	8.726-114.0	8.726-115.0	8.726-116.0

QC Soap Nozzle

Part #	Orifice	Degree	List Price	10+
8.723-636.0	40	65°	\$4.40	\$4.12

Legacy Compact Foamer

Generates a high-density clinging foam for extended dwell time to increase chemical action.



- Stainless-steel, aluminum and brass
- 5" long, 1" diameter
- 4 and 6.5 nozzle included
- 1-5 GPM max flow
- 195°F max temperature
- 2500 PSI max pressure

Part #	Old No.	Description	List Price
8.903-998.0	344022V	1/8" F Inlet	\$60.96
8.903-999.0	344023V	1/4" F Inlet	\$56.20

NOTE: Most cleaning chemicals perform best when applied at 120°-150°F and can be applied as a foam by adding a foaming agent. See your chemical supplier to obtain the correct product.

Brass Chemical Filter

50-mesh, stainless-steel screen. Removable mesh for easy cleaning. Heavy-duty, one-piece brass body holds the filter on the bottom of tank.



- 1/4" hose barb
- Stainless-steel check ball
- Silver outer coating with brass underneath

Part #	Old No.	Description	List Price
9.803-672.0	340010X	With Check Valve	\$4.74
8.709-934.0	340012X	Without Check Valve	\$4.66

Legacy

Undercarriage Cleaner

- No more crawling under a vehicle
- Simply connect to your hot or cold water pressure washer
- Easy to handle and maneuver
- Removes road grime, fuel and oil contaminants
- Removes snow sludge and ice
- Provides a clean, working environment for technicians
- Stainless-steel rotating assembly built to withstand pressures up to 4000 PSI and 250°F
- 5.5" required clearance
- Four Nozzles:
(2) 0° #2.0, (2) 25° #2.0



Part #	Description	List Price
8.749-303.0	Undercarriage Cleaner	\$1,152.57

Oil-Fired Hot Box

Add hot water cleaning economically! Portable water heater add-on for existing cold water pressure washers. Quick Connect to cold water washer, supply fuel and power to Euro-Heat for hot water cleaning applications — USE ONLY WHEN NEEDED and keep the convenience of the portable cold water washer.



- 3000 PSI
- Quick hookup — 3/8" QC inlet / outlet
- Easy service access to burner parts
- Efficient vertical combustion configuration
- Diesel, kerosene, #1 heating oil
- 10" easy-roll tubed pneumatic wheels
- 5-gallon plastic fuel tank
- Compact size — 37" W x 27" L x 39" H
- 36' Ground Fault Interrupter plug
- Thermostat temperature control

Part #	Original No.	Description	List Price
1.103-910.0	HR-5030D	5 GPM / 3000 PSI – 120V	\$3,578.22

Legacy HD Pumps – Direct Drive Units



GS SERIES:

- 1/2" inlet x 3/8" outlet
- Direct couple-to-gas engine

Part #	Model #	GPM	PSI	HP	RPM	Shaft	Weight	List Price
8.751-207.0	GS4040G.3	4.0	4000	13.0	3400	1" Hollow	23 lbs	\$702.77



GE SERIES:

- 1/2" inlet x 3/8" outlet
- NEMA 56C Frame
- Direct couple-to-electric motor

Part #	Model #	GPM	PSI	HP	RPM	Shaft	Weight	List Price
8.916-560.0	GE2825S.1	2.8	2500	5.0	1725	5/8" Hollow	17 lbs	\$597.20

Legacy^{HD}

Legacy^{HD}

Legacy HD Pumps – Belt Drive Units

Legacy^{HD}



GM SERIES:

- 1/2" inlet x 3/8" outlet

Part #	Model #	GPM	PSI	HP	RPM	Shaft	Weight	List Price
8.751-200.0	GM4035R.3	4.8	3500	7.5	1500	24mm	22 lbs	\$790.74

Legacy Flow Switch

Spring-return float allows full mounting versatility.

Legacy



- 4050 PSI
- 3500-rated pressure
- Horizontal or vertical mount
- Forged-brass body
- 48" wire length
- 2-wire reed
- 3/8" MPT inlet/outlet
- 8 GPM
- 190°F
- One Amp switch
- Solenoid control

Part #	Old No.	Description	List Price
8.712-246.0	410307P	Flow Switch	\$61.70
9.803-266.0	109672	Reed Switch Only	\$34.93

Pressure Switch

Operation without opening switch case: Blue=Common
CONNECT: Red/Blue=N/C, Blue/Brown=N/O

Legacy



- 200°F
- Stainless-steel plunger
- 3600 PSI
- 1/4" MPT nipple
- 15 Amp — 115 or 230V AC
- 3-wire — internally wired for either N/O or N/C
- 42" wire length

Part #	Old No.	Description	List Price
8.712-261.0	411060	Pressure Switch (Switches@360 PSI)	\$32.34
8.712-262.0	411060-40	P. Switch 3/8" MPT (Switches@580 PSI)	\$34.92
8.701-311.0	082023	Micro Switch (15 Amp 115/230V AC)	\$18.95

NOTE: 10 AMP 28V DC Micro Switch available. Excellent for use on 12V DC Hot Pressure Washers.

Flow Control Metering Valve

The valve that "seals" (will not suck air).

AP



- 3500 PSI to 28" vacuum — no leak
- Viton gland seal isolates metering threads from solution
- Stainless-steel needle/brass seat
- 1/4" FPT ports
- Heavy-duty brass bar stock body
- 195°F rated temperature
- Panel mounts 5/8" hole
- Large easy-grip four-lobe handwheel
- Aluminum or poly available

Part #	Old No.	Description	List Price
8.904-362.0	371120X	Metering Valve / Alum Knob	\$25.93
8.904-361.0	371120P	Metering Valve / Poly Knob	\$25.46
8.740-083.0	077003A	Replacement Knob	\$1.97

Fuel Filter / Water Separator

Legacy



- 10 micron filtration
- Spin-on convenience
- Water-separation chamber
- 1/4" FPT inlet / outlet
- Easy drain water / sediment bowl

Part #	Description	List Price
8.725-306.0	Complete Unit	\$62.63
8.725-307.0*	Element Only	\$19.72

*Order 24 for a full case

Legacy Universal Unloader (UU1)

Legacy



Patent Pending

The Legacy Universal Unloader is unique in that it allows for height or width adjustments making it ideal for any pump.

- 6 GPM
- 3500 PSI
- 195°F
- Forged-brass body
- 1/2" NPT inlet
- 3/8" NPT outlet
- Stainless-steel seat and low-friction, wear-resistant plunger
- 16.1 oz weight

Part #	Description	List Price
9.175-018.0	Legacy Universal Unloader (UU1)	\$123.60

Legacy Stackable Hose Reels

Hose reels built specifically for contractors who require flexibility on a job site. Stackable reels are supported on both sides of the central hub to accommodate more aggressive applications, such as trailer-mounted.



200' Mild Steel Stackable Hose Reel

100' Mild Steel Stackable Hose Reel



Stainless Steel Stackable Hose Reel

200' Mild Steel Stackable Hose Reel with Optional Hose Guide and Hose Reel Riser

200' Mild Steel Stackable Hose Reels with Optional Reel Cart System and Hose Guide

Reel Cart System

Hose Reel Riser

Hose Guide

*Patent D739,715S and other Patents Pending

Specifications:

- Integrated frame adds protection and stacking ability
- Stacked up to 3 high
- Heavy-duty powder-coated steel or stainless steel
- Reel and swivel rated up to 6000 PSI and 350°F
- Modular design is able to configure for various needs
- Reversible hand-crank and swivel

Part #	Description	Length	List Price
9.801-767.0	Stackable Hose Reel, Mild Steel	100'	\$350.00
9.801-768.0	Stackable Hose Reel, Mild Steel	200'	\$380.00
9.801-769.0	Stackable Hose Reel, Stainless Steel	100'	\$720.00
9.801-770.0	Stackable Hose Reel, Stainless Steel	200'	\$810.00

NOTE: Hose not included

Part #	Description	List Price
8.923-415.0	Hose Guide, 100' Reel	\$97.00
8.923-427.0	Hose Guide, 200' Reel	\$105.00
8.923-416.0	Hose Reel Riser	\$155.00
8.923-918.0	Reel Cart System	\$155.00

Legacy Hose Reels

Fully assembled and ready to use!

Legacy hose reels were designed for ease of use and durability in commercial pressure washer applications.

Offering 100' and 200' reels in both a fixed base and 360 degree rotating base. The oversized reel holds the advertised length plus leaves additional space reducing the difficulty of reeling hose. The unique extended swivel improves the hose connection and reduces hose wear and stress.

Features:

- 1. Rugged heavy-duty construction** for commercial applications.
 - Heavy gauge steel fabrication
 - Gloss black powder coating
 - Easy to use brake mechanism reduces unwinding backlash
 - Oversized heavy-duty locking mechanism prevents slippage during reel operation.
 - Durable handle
- 2. "Flip-Over" hose guide:** Allows ease of use from either side of the reel
- 3. Oversized:** Oversized to easily fit the advertised length of hose. When we say 100' we mean 100+ feet will easily fit.
- 4. New swivel design:** The reels come with an extended swivel which prevents bends and stress on the hose where it attaches to the reel. Swivels carry a two year warranty.
- 5. Rotary mount:** 360 degree rotation with an oversized heavy-duty locking mechanism. Allows for continual alignment with the hose.
 - Mount to round or square tubing
- 6. Fully assembled:** Ready to use out of the box. Saves time and money.

Specifications:

- 5000 PSI
- 325°F
- 100'- and 200'-fixed base
- 100'- and 200'-360° rotating base
- High-pressure, double-seal swivels
- Reels equipped for 3/8" hose. Easily convertible to 1/2" hose with the change to a 1/2" swivel
- 2-year warranty



360° Pivot Reel

Fixed Base Hose Reel

Part #	Description	Length	List Price
8.750-485.0	Pivot Reel	100' x 3/8"	\$346.73
8.750-482.0	Pivot Reel	200' x 3/8"	\$386.93
8.750-476.0	Fixed Based	100' x 3/8"	\$266.33
8.750-479.0	Fixed Based	200' x 3/8"	\$279.39

NOTE: Hose not included



A-Plus is our quality, value-line of pressure washer parts and accessories. High on performance, low on price.

A-Plus is available exclusively at Spraymart. Look for this symbol throughout the catalog:

AP Trigger Gun



- **PSI: 4000**
- **GPM: 8**
- **Temperature: 320°F**
- 3/8" FPT inlet x 1/4" FPT outlet
- Weight: 13.4 oz

Part #	Old No.	Description	List Price
8.710-417.0	353030	MV2005	\$31.10

Brass Quick Couplers

Designed for 4000 PSI and extended durability. EPDM O-rings as standard. Affordable and rugged all in one.



Part #	Description	List Price
8.750-695.0	Coupler 1/4" Socket FPT	\$3.78
8.750-696.0	Coupler 1/4" Socket MPT	\$3.78
8.750-697.0	Coupler 3/8" Socket FPT	\$4.61
8.750-698.0	Coupler 3/8" Socket MPT	\$4.66

Turbo Nozzles

AP Revolution Turbo Nozzle is rated for up to 5100 PSI at 212°F. High-impact nozzle at unbelievable pricing!

- Forged brass
- Precision ceramic
- Durable rubber cover



3000 PSI



4000 PSI



5100 PSI

Nozzle Part #	Orifice	List Price	3+	5+
3000 PSI				
8.726-056.0	3.5	\$50.72	\$47.12	\$44.64
8.726-057.0	4.0	\$50.72	\$47.12	\$44.64
8.726-058.0	4.5	\$50.72	\$47.12	\$44.64
8.726-059.0	5.0	\$50.72	\$47.12	\$44.64
8.726-060.0	5.5	\$50.72	\$47.12	\$44.64
8.726-061.0	6.0	\$50.47	\$47.12	\$44.64
4000 PSI				
8.726-068.0	3.5	\$56.87	\$52.79	\$50.11
8.726-069.0	4.0	\$56.60	\$52.79	\$50.11
8.726-070.0	4.5	\$56.60	\$52.79	\$50.11
8.726-071.0	5.0	\$56.87	\$52.79	\$50.11
8.726-072.0	5.5	\$56.60	\$52.79	\$50.11
8.726-073.0	6.0	\$56.87	\$52.79	\$50.11
5100 PSI				
8.726-080.0	3.5	\$104.54	\$96.19	\$91.14
8.726-081.0	4.0	\$104.54	\$96.19	\$91.14
8.726-082.0	4.5	\$104.54	\$96.19	\$91.14
8.726-083.0	5.0	\$104.54	\$96.19	\$91.14
8.726-084.0	5.5	\$104.54	\$96.19	\$91.14
8.726-085.0	6.0	\$104.54	\$96.19	\$91.14

Repair Kit Part #	Orifice	List Price
3000 PSI		
8.726-062.0	3.5	\$25.62
8.726-063.0	4.0	\$25.62
8.726-064.0	4.5	\$25.62
8.726-065.0	5.0	\$25.62
8.726-066.0	5.5	\$25.62
8.726-067.0	6.0	\$25.49
4000 PSI		
8.726-074.0	3.5	\$33.43
8.726-075.0	4.0	\$33.43
8.726-076.0	4.5	\$33.43
8.726-077.0	5.0	\$33.43
8.726-078.0	5.5	\$33.43
8.726-079.0	6.0	\$33.43
5100 PSI		
8.726-086.0	3.5	\$55.68
8.726-087.0	4.0	\$55.68
8.726-088.0	4.5	\$55.68
8.726-089.0	5.0	\$55.68
8.726-090.0	5.5	\$55.68
8.726-091.0	6.0	\$55.68

Adjustable Nozzle



Compact, full-feature unit weighs only 4.3 oz, same functions as ST-51N.



- 3600 PSI max pressure
- 10 GPM max flow
- 300°F max temperature
- Machined-brass body
- Nylon adjustment knob
- 1/4" FPT inlet/outlet

Part #	Old No.	Description	List Price
8.710-891.0	373051P	Adjustable Nozzle	\$18.16

Stainless-Steel Sewer Nozzles



- 4100 PSI max pressure
- Corrosion-resistant stainless-steel
- One forward orifice
- Three rear orifices

Part #	Old No.	FPT	Size	List Price
8.710-905.0	373075	1/8"	5.0	\$17.28
8.710-906.0	373076	1/8"	5.5	\$17.28
8.710-907.0	373077	1/8"	6.0	\$17.44
8.710-908.0	373078	1/4"	6.5	\$18.79
8.710-909.0	373079	1/4"	7.0	\$18.79
8.710-910.0	373080	1/4"	9.5	\$18.94



AP Hose Reels

AP hose reels have been designed to perfectly balance ruggedness and durability with affordability.



- Flared flanges for maximum capacity
- Solid center core for maximum strength
- Rolled, beaded-edge flanges for maximum safety
- Easy mounting options for maximum versatility
- "Posi-Pin" lock prevents unwanted dereeling
- Heavy-duty powder-coated steel
- Easy access external swivel
- 4000 PSI working pressure
- Rated temperature: 225°F
- 3/8" or 1/2" inlet/outlet

Part #	Old No.	Hose Dia	Capacity (in feet)	Core Width	Flange Width	Flange Diameter	Overall Height	List Price
8.711-192.0	386188	3/8"	50	4.3	7.9	10.5	13.0"	\$105.57
9.804-067.0	386191	3/8"	100	8.7	12.2	10.5	13.0"	\$107.54
8.711-199.0	386206	3/8"	150	6.3	10.2	13.0	16.7"	\$141.71
8.711-201.0	386209	1/2"	100	6.3	10.2	13.0	16.7"	\$114.89

NOTE: Hose is not included in price. See page 25 for connector hose.

Swivel Repair Kits

Part #	Old No.	List Price
8.900-855.0	110025	\$6.13

Stainless-Steel Swivels



- Swivels even at 4000 PSI
- 200°F max temperature
- All stainless construction
- Teflon® swivel ring
- Rebuildable
- 3/8" in and out

Part #	Old No.	Description	List Price
8.712-446.0	421016	3/8" MPT x FPT	\$26.29
8.712-447.0	421017	3/8" FPT x FPT	\$27.58
8.900-764.0	109198	Seal Kit	\$4.61
8.900-765.0	109199	Rebuild Kit	\$9.63

Water Broom 16"



- 4000 PSI
- Fits any 1/4" wand
- Requires (4) 1/4" nozzles and wand

Part #	Original No.	Description	List Price
8.710-082.0	343615	Water Broom 16"	\$63.91

A+ Surface Cleaner



Fast, even cleaning for large flat surfaces. Quickly cleans concrete & asphalt, and removes grime and deposits from tennis courts, ramps, and decks. Also great for factory floors, semi-trailer floors & drive-throughs. Cleans better and faster than spray wand alone, with no striping. Use with hot or cold water. Handles water up to 212° F to disinfect bathrooms and kitchens. Safety lock prevents accidental spraying.



- Two spinning nozzles 'floats' cleaner above the ground
- Circular design allows a zero wall clearance
- Stainless steel housing and handle
- Comfort Grip trigger handle
- 3/8" male quick connector plugs into your pressure washer's hose
- Reduces overspray on walls, landscaping, and operator
- Comes with two #2.0 nozzles (for machines up to #4.0 nozzles), 25° nozzles rated up to 8 GPM & 4000 PSI
- Requires at least 3 GPM & 2000 PSI

Part #	Description	List Price
8.753-572.0	A+SC21 Rotary Surface Cleaner, 21"	\$804.32
8.753-573.0	A+SC24 Rotary Surface Cleaner, 24"	\$900.34

Surface Cleaner Nozzle Recommendation

Determine the correct nozzle size for the pressure washer being used with the surface cleaner. Never use a smaller size nozzle as this will prematurely wear out the unloader valve on the pressure washer. The Legacy Undercarriage Cleaner and A+ Surface Cleaners come supplied with nozzles, for other surface cleaners, nozzles must be purchased separately. Threaded nozzles are listed on pages 45-46 of the catalog, to determine your pressure washer nozzle size refer to chart on page 43. Contact your RSM on other sizes or surface cleaner spray bars that use 4 nozzles or other sizes.

Pressure Washer Nozzle Size		15° x 1/4" MPT	25° x 1/4" MPT
# 3.5 and # 4.0	2 each	#2.0	#2.0
#4.5 and # 5.0	2 each	#2.5	#2.5
# 5.5 and # 6.0	2 each	#3.0	#3.0
# 6.5 and # 7.0	2 each	#3.5	#3.5
# 7.5 and # 8.0	2 each	#4.0	#4.0

Legacy "Best" Spray Gun

Ergonomically designed to be the most comfortable gun on the market.



- **PSI: 5000**
- **GPM: 12**
- **Temperature: 300°F**
- 3/8" FPT inlet x 1/4" FPT outlet
- Weight: 21 oz
- Ideal for commercial cleaning and long work time applications

Part #	Description	List Price
8.751-213.0	"Best" Spray Gun	\$49.39
8.701-673.0	Unitized Valve Kit	\$14.65

Legacy "Industrial" Spray Gun

Featuring a comfortable grip to reduce user fatigue.



- **PSI: 5000**
- **GPM: 10.4**
- **Temperature: 300°F**
- 3/8" FPT inlet x 1/4" FPT outlet
- Weight: 19.84 oz
- Ideal for various industrial cleaning applications

Part #	Description	List Price
8.751-214.0	"Industrial" Spray Gun	\$37.90
8.751-119.0	Valve Kit	\$19.61

AP Trigger Gun



- **PSI: 4000**
- **GPM: 8**
- **Temperature: 320°F**
- 3/8" FPT inlet x 1/4" FPT outlet
- Weight: 13.4 oz

Part #	Old No.	Description	List Price
8.710-417.0	353030	MV2005	\$31.10

M407 Trigger Gun



- **PSI: 4000**
- **GPM: 7**
- **Temperature: 250°F**
- 3/8" FPT inlet x 1/4" FPT outlet
- Weight: 13.4 oz

Part #	Description	List Price
8.750-247.0	M407 Trigger Gun	\$25.65
8.750-456.0	M407 Gun Repair Kit	\$14.13

J.E. Adams Gun



- **PSI: 4500**
- **GPM: 12**
- **Temperature: 300°F**
- 3/8" FPT inlet x 1/4" FPT outlet

Part #	Description	List Price
8.710-391.0	J.A. Trigger Gun	\$57.96

Giant Trigger Guns



The original "heavy-weight".



- **PSI: 5000**
- **GPM: 10**
- **Temperature: 300°F**
- 3/8" FPT inlet x 1/4" FPT outlet
- Weight: 29.28 oz

21290C

Part #	Old No.	Description	List Price
8.710-394.0	352290	21290C – Brass Outlet	\$49.85
8.710-392.0	352250	21250B – Stainless-Steel Outlet	\$62.16
8.722-172.0	G021227	Repair Kit	\$12.83

Suttner Trigger Guns



ST-2620

- **PSI: 1800**
- **GPM: 21**
- **Temperature: 300°F**
- 3/8" FPT inlet x 1/4" FPT outlet
- Weight: 1.30 lb

Part #	Old No.	Description	List Price
8.723-666.0	87236660	ST-2620	\$122.13
8.723-667.0	87236670	ST-2720 Stainless-steel	\$249.44

Excellent for truck and fleet washing applications.



ST-810 POM

- **PSI: 2000**
- **GPM: 8**
- **Temperature: 320°F**
- 3/8" FPT inlet x 1/4" FPT outlet
- Weight: .82 lb

Part #	Old No.	Description	List Price
8.710-372.0	352210P	ST-810 Gun	\$42.02

15° offset angle thru gun for easier overhead use.



ST-601

- **PSI: 4000**
- **GPM: 12**
- **Temperature: 300°F**
- 3/8" FPT inlet x 1/4" FPT outlet
- Weight: 23 oz

Part #	Old No.	Description	List Price
8.710-370.0	352201	ST-601	\$47.18
8.701-663.0	089614	Unitized Valve – 4000 PSI	\$17.96
8.751-119.0		Unitized Valve – 5000 PSI	\$19.61



ST-2605

- **PSI: 5000**
- **GPM: 12**
- **Temperature: 300°F**
- 3/8" FPT inlet x 1/4" FPT outlet
- Weight: 21 oz

Part #	Old No.	Description	List Price
8.710-376.0	352219	ST-2605	\$60.41
8.701-673.0	089850	Unitized Valve	\$14.65

Extreme durability with easy pull trigger.



ST-2305

- **PSI: 5000**
- **GPM: 12**
- **Temperature: 300°F**
- 3/8" FPT inlet x 1/4" FPT outlet
- Weight: 21 oz

Part #	Old No.	Description	List Price
8.710-386.0	352238	ST-2305	\$47.29
8.701-673.0	089850	Unitized Valve	\$14.65
8.701-674.0	089851	Unitized Weep Valve	\$18.99

Suttner Trigger Guns



15° offset angle thru gun for easier overhead use. The handle style for "Big Hands".



ST-2000

- **PSI: 5000**
- **GPM: 12**
- **Temperature: 300°F**
- 3/8" FPT inlet x 1/4" FPT outlet
- Weight: 26 oz

Part #	Old No.	Description	List Price
8.710-388.0	352240	ST-2000	\$47.23
8.701-663.0	089614	Unitized Valve – 4000 PSI	\$17.96
8.751-119.0		Unitized Valve – 5000 PSI	\$19.61
8.701-665.0	089631	Unitized Weep Valve	\$30.48

The perennial favorite for general pressure washer applications.



ST-1500

- **PSI: 5000**
- **GPM: 10.4**
- **Temperature: 300°F**
- 3/8" FPT inlet x 1/4" FPT outlet
- Weight: 20.5 oz

Part #	Old No.	Description	List Price
8.710-384.0	352235	ST-1500	\$42.80
8.710-385.0	352236	ST-1500 w/ Weep	\$45.70
8.701-663.0	089614	Unitized Valve - 4000 PSI	\$17.96
8.751-119.0		Unitized Valve - 5000 PSI	\$19.61
8.701-665.0	089631	Unitized Weep Valve	\$30.48
8.710-383.0		ST-1500 Open Gun	\$25.10

Relax action design, stainless-steel gun.



ST-2700

- **PSI: 5000**
- **GPM: 12**
- **Temperature: 300°F**
- 3/8" FPT inlet x 1/4" FPT outlet
- Weight: 21 oz

Part #	Old No.	Description	List Price
8.710-389.0	352243	ST-2700	\$155.53
8.701-658.0	089070	Unitized Valve	\$33.33

Ceramic Unitized Ball Valve



- Ceramic ball
- Highly resistant against nearly all soaps and acids
- Fits in ST-2300, 2305, 2605, 2700 spray guns as a repair kit

Part #	Description	List Price
8.749-907.0	Ceramic Unitized Ball Valve	\$47.56

PA Trigger Gun



- **PSI: 3200**
- **GPM: 8**
- **Temperature: 320°F**
- 3/8" FPT inlet x 1/4" FPT outlet
- Weight: 10 oz

Part #	Old No.	Description	List Price
8.710-440.0	353207	RL20	\$38.97
8.704-180.0	109993	Repair Kit	\$20.75



- **PSI: 5000**
- **GPM: 10.5**
- **Temperature: 300°F**
- 3/8" FPT inlet x 1/4" FPT outlet
- Weight: 26 oz

Part #	Old No.	Description	List Price
8.710-377.0	352221	RL30-YG5000	\$58.79
8.704-616.0	111976	Repair Kit	\$22.77



- **PSI: 5000**
- **GPM: 10.5**
- **Temperature: 300°F**
- 3/8" FPT inlet x 1/4" FPT outlet
- Weight: 27.5 oz

Vega 5000

Part #	Old No.	Description	List Price
8.710-378.0	352222-5	Vega 5000	\$55.36
8.704-232.0	110550	Valve Kit Vega	\$79.59
8.704-615.0	111950	Repair Kit	\$18.63

Easy pull and easy to hold with matching blue lance.



- **PSI: 5650**
- **GPM: 8**
- **Temperature: 320°F**
- 3/8" FPT inlet x 1/4" BSP outlet
- Weight: 23.3 oz
- Blue vent grip, stainless-steel lance has 1/4" BSP threads

RL-55 Blue and Lance



Part #	Old No.	Description	List Price
9.802-227.0		RL-55 Blue Gun and Wand	\$200.79
8.710-446.0	353250	RL-55 Blue Gun	\$104.03
8.710-645.0	368440PB	40" Stainless-Steel Lance w/ blue vent grip	\$94.19
8.704-610.0	111814	Repair Kit - RL-55	\$17.39

Mecline AL 35 Gun



Easy pull, easy hold!



- **PSI: 5000**
- **GPM: 8**
- **Temperature: 302°F**
- 3/8" FPT inlet x 1/4" FPT outlet
- Weight: 20 oz

Part #	Old No.	Description	List Price
8.720-563.0	AL016650016	Repair Kit	\$24.53

Big Guns



- **PSI: 3200**
- **GPM: 53**
- **Temperature: 320°F**
- 3/4" F inlet / 1/2" outlet
- Weight: 47.5 oz

Model RL204



- **PSI: 7250**
- **GPM: 21**
- **Temperature: 210°F**
- 1/2" Stainless-steel FPT inlet/outlet
- Weight: 60.3 oz

Model RL84 "Big Black Gun"

Part #	Old No.	Description	List Price
8.740-165.0		Model RL204	\$527.85
8.749-327.0		Repair Kit - Model RL204	\$231.84
8.704-136.0	109775	Repair Kit - Model 100	\$124.20
8.704-612.0	111900	Repair Kit - Model 160	\$322.92
8.710-445.0	353246	Model RL84	\$516.47
8.750-459.0		Repair Kit	\$368.46

MV Hobby Wash Gun



Excellent light-duty gun.



- **PSI: 1850**
- **GPM: 5**
- **Temperature: 180°F**
- 1/4" M inlet x 1/4" F outlet
- Weight: 8.4 oz

Hobby Wash Gun

Part #	Old No.	Description	List Price
8.710-419.0	353040	Hobby Wash Gun	\$27.48

NOTE: See pages 18 for Hobby Unit parts

AP1000 Open Gun

Durable glass reinforced handle.



AP-1000 Open Gun

- **PSI: 4000**
- **GPM: 12**
- **Temperature: 300°F**
- 3/8" FPT inlet x 1/4" FPT outlet
- Tubular flow-thru internals for high pressure and efficiency
- Weight: 16.7 oz

Part #	Old No.	Description	List Price
8.710-396.0	352600	Legacy AP1000 Open Gun	\$29.29

Open Guns

Just plain comfortable!



AP-740 Open Gun

- **PSI: 4000**
- **GPM: 7**
- **Temperature: 300°F**
- 3/8" FPT inlet x 1/4" FPT outlet
- Weight: 12.2 oz

Part #	Old No.	Description	List Price
8.710-425.0	353050	AP740 Open Gun	\$21.84

Flow-Thru Gun



"Full" Grip

- Pistol-grip gun handle
- Tough polyurethane insulation
- Cushion grip
- Full grip or slim line handle

Gun Handle Only

Part #	Old No.	Description	List Price
8.710-400.0	352606	Full Black Grip 3/8" FPT x 1/4" FPT	\$35.14

Gun Handle w/ 18" Lance

8.710-403.0	352614	Slim Red Grip 1/4" M x 1/4" F	\$32.96
8.710-404.0	352616	Full Red Grip 3/8" F x 1/4" M	\$46.01

AP Dump Guns

Water continues to run through the tube even when trigger gun is closed.



AP Single Barrel Dump Gun

- **PSI: 3000**
- **GPM: 10.5**
- **Temperature: 140°F**
- 3/8" FPT inlet x 1/8" FPT outlet

Part #	Old No.	Description	List Price
8.710-405.0	352810	Dump Gun 16" Lance	\$113.85
8.710-406.0	352812	Dump Gun 40" Lance	\$129.38
8.704-169.0	109905	Repair Kit	\$26.55

Dump Gun

Industrial duty dual-barrel.



Dual Barrel Dump Gun

- **PSI: 3000**
- **GPM: 10**
- **Temperature: 200°F**
- 3/8" FPT inlet x 1/4" FPT outlet

Part #	Old No.	Description	List Price
8.710-408.0	352820	Dump Gun w/ 36" Barrel	\$315.18
8.700-311.0	075296	Repair Kits	\$48.41

Legacy Superlite Stainless-Steel Dual Lance



Superlite stainless-steel with nozzle guard.



Dual Lance w/ Nozzle Guard

- **PSI: 4000**
- **Temperature: 200°F**
- Side handle / valve actuator
- Viton seal
- Forged brass valve body
- 1/4" MPT inlet
- 1/8" stainless-steel outlet tubing

Part #	Old No.	Description	List Price
8.710-618.0	368160	36" - 37.8 oz	\$83.79
8.710-620.0	368165	72" - 56.0 oz	\$106.61
8.900-781.0	109490	Seal Kit	\$2.85

Legacy Square Molded Grip Lances



Legacy

- **PSI: 5250**
- **Temperature:** 300°F
- 1/4" male inlet and outlet
- High-quality chrome-plate finish
- Solid molded polymer construction handle with hollow-rib grip for increased heat dissipation

Part #	Description	List Price
8.752-898.0	Lance, Molded, 12"	\$9.52
8.752-899.0	Lance, Molded, 20"	\$11.07
8.752-900.0	Lance, Molded, 24"	\$11.59
8.752-901.0	Lance, Molded, 28"	\$12.11
8.752-902.0	Lance, Molded, 36"	\$13.01
8.752-903.0	Lance, Molded, 48"	\$19.93
8.752-904.0	Lance, Molded, 60"	\$25.25
8.752-905.0	Lance, Molded, 79"	\$32.91

Legacy Oval Molded Grip Lances

Featuring a comfortable grip to reduce user fatigue.



- **PSI: 5250**
- **Temperature:** 300°F
- 1/4" male inlet and outlet
- 4:1 safety factor
- Stainless-steel or high-quality chrome-plate finish
- Solid molded polymer construction handle with hollow rib grip for increased heat dissipation

Part #	Description	List Price
Stainless-steel		
8.752-882.0	Lance, Molded, 12"	\$12.26
8.752-883.0	Lance, Molded, 20"	\$17.39
8.752-884.0	Lance, Molded, 24"	\$17.65
8.752-885.0	Lance, Molded, 28"	\$19.72
8.752-886.0	Lance, Molded, 36"	\$26.37
8.752-887.0	Lance, Molded, 48"	\$38.11
8.752-888.0	Lance, Molded, 60"	\$44.09
8.752-889.0	Lance, Molded, 79"	\$53.10
Chrome-plated		
8.752-890.0	Lance, Molded, 12"	\$7.76
8.752-891.0	Lance, Molded, 20"	\$9.78
8.752-892.0	Lance, Molded, 24"	\$11.02
8.752-893.0	Lance, Molded, 28"	\$12.11
8.752-894.0	Lance, Molded, 36"	\$14.21
8.752-906.0	Lance, Molded, 36", with handle	\$17.49
8.752-895.0	Lance, Molded, 48"	\$21.12
8.752-907.0	Lance, Molded, 48", with handle	\$23.49
8.752-896.0	Lance, Molded, 60"	\$25.49
8.752-897.0	Lance, Molded, 79"	\$30.64

Dual Lances



Interpump Dual Lance

- **PSI: 3000**
- **GPM: 10**
- **Temperature:** 220°F
- Excellent for downstream injector
- Zinc-plated for chemical resistance
- Brass and stainless-steel valve w/ Viton seals
- Side handle valve adjustment
- Non-deluxe outlet 1/4" FPT

Part #	Old No.	Description	List Price
8.710-612.0	368150	36" Standard	\$113.30
8.710-621.0	368172	72" Extended	\$144.90
8.904-277.0	368151X	36" Deluxe Standard	\$122.57
8.904-281.0	368173X	72" Deluxe Extended	\$173.04
8.900-135.0	084072X	Valve Repair Kit	\$49.63

Dual Lances



Premium lance with stainless-steel inserted seat.



AL Premium Dual Lance

- **PSI: 3600**
- **GPM: 10.5**
- **Temperature:** 302°F
- 1/4" tubing
- Vented grip
- 1/4" male inlet-female outlet



AL Basic Dual Lance

- **PSI: 3600**
- **GPM: 10.5**
- **Temperature:** 302°F
- 1/4" male inlet-female outlet
- 1/8" zinc-plated tubes
- Square-molded grip inlet

Part #	Old No.	Description	List Price
8.710-722.0	368925	Stainless-steel Pipe	\$86.01
9.803-267.0	AL8355VPKIT	Repair Kit	\$54.65
8.710-724.0	368927	Basic Dual Lance	\$61.63
8.720-548.0	AL004650300	Repair Kit	\$5.18
8.904-360.0*	368926X	AL Premium Deluxe w/ Quick Coupler and Soap Nozzle	\$106.09



Includes hardened-steel QC inlet plug, 1/8" 40 x 65° soap nozzle and top-quality quick coupler.

See lances with deluxe noted above.

Suttner Dual Lances



ST-54
w/ Side Handle



ST-53 w/ Knob

- **GPM:** 10
- **Temperature:** 300°F
- Zinc/chromate finish
- 38" total length
- Molded grip
- High-pressure, thin-wall tubing
- Weight: 42 oz

Part #	Old No.	Description	List Price
8.710-613.0	368153	ST-53 w/ Knob (4000 PSI)	\$69.86
8.710-614.0	368154	ST-54 w/ Side Handle (4500 PSI)	\$76.18
8.701-594.0	086884	Repair Kit (ST-53)	\$16.61
8.900-153.0	086883X	Clamp Kit (ST-53/54)	\$6.47
8.701-602.0	086907	Repair Kit (ST-54)	\$27.89

Dual Trigger Lance

Unique Design – Go from high- to low-pressure (rinse-to-soap) with a pull of the trigger. Use with separate trigger gun or as an open gun, and still change from high to low.



- **PSI:** 3600
- **GPM:** 12
- **Temperature:** 300°F
- Zinc-plated steel tubes
- Stainless-steel seat
- Includes nozzle protector
- Weight: 39 oz

Part #	Old No.	Description	List Price
8.710-617.0	368158	48" Dual Trigger Lance	\$80.47
8.900-781.0	109490	Seal Kit	\$2.85

Legacy Vented Lances



- **PSI:** 5250
- **Temperature:** 300°F
- Handle made from molded glass-filled polyamide for heat dissipation with hollow insulators for increased heat venting
- Nozzle protector included
- 1/4" male inlet, 1/4" female outlet
- 4:1 safety factor
- Stainless-steel or high-quality chrome-plate finish

Part #	Description	List Price
Stainless-steel		
8.752-868.0	Lance, Vented, 20"	\$19.41
8.752-869.0	Lance, Vented, 24"	\$23.75
8.752-871.0	Lance, Vented, 36"	\$28.98
8.752-872.0	Lance, Vented, 48"	\$36.33
8.752-873.0	Lance, Vented, 60"	\$41.24
8.752-874.0	Lance, Vented, 79"	\$53.15
Chrome-plated		
8.752-875.0	Lance, Vented, 20"	\$13.04
8.752-876.0	Lance, Vented, 24"	\$13.97
8.752-878.0	Lance, Vented, 36"	\$19.11
8.752-879.0	Lance, Vented, 48"	\$22.61
8.752-880.0	Lance, Vented, 60"	\$26.65
8.752-881.0	Lance, Vented, 79"	\$32.45

AP Uninsulated Lances

Stainless-steel or corrosion-resistant, bright zinc-plated lances made with 1/4" tubing.



- **PSI: 4100**
- **Temperature:** 300°F

- Superior strength rolled threads
- 1/4" high-pressure, lightweight, thin-wall tubing

Part #	Old No.	Length	List Price
Stainless-steel			
8.710-623.0	368212	12"	\$9.83
8.710-624.0	368220	20"	\$11.18
8.710-625.0	368224	24"	\$12.26
8.710-626.0	368228	28"	\$15.42
8.710-627.0	368236	36"	\$17.39
8.710-628.0	368248	48"	\$23.08
8.710-629.0	368260	60"	\$29.86
8.710-630.0	368278	78"	\$39.74
Zinc-plated			
8.710-631.0	368312	12"	\$3.83
8.710-632.0	368320	20"	\$6.57
8.710-633.0	368324	24"	\$5.33
8.710-634.0	368336	36"	\$11.02
8.710-635.0	368348	48"	\$12.42
8.710-636.0	368360	60"	\$15.78
8.710-637.0	368378	78"	\$22.36

NOTE: For 15° bend at lance discharge, place "BND" at end of the old part number.

Suttner Push and Pull Lance



Vented grip can be pushed and pulled up to 90°. For hard to reach applications, such as gutters, fenders, trucks and heavy equipment.



- **PSI: 3050**
- **Temperature:** 300°F
- 34" stainless-steel lance

Part #	Old No.	Description	List Price
8.710-711.0	368880	ST-85 Push and Pull Lance	\$170.98

Big Stainless-Steel Lances and Side Handles

For big guns!



- **PSI: 4050**
- **Temperature:** 300°F

- High-pressure stainless-steel pipe
- Complete with adjustable handle and coupler for 1/4" MPT nozzle
- 1/2" MPT gun connection
- Schedule 40 pipe

Part #	Old No.	Description	List Price
8.904-081.0	352902A	20" Wand w/ Handle	\$140.76
8.904-083.0	352904A	40" Wand w/ Handle	\$139.73
8.904-086.0	352906A	Side Handle Only	\$38.45
8.710-411.0		39", Stainless-Steel, 8700 PSI 300°F Inlet 1/2" MNPT, Outlet 1/4" MNPT	\$208.04

Lance Handles/Accessories

Vented grip, side handle with nut, and vented grip with side handle, can be user-attached to uninsulated lances or 1/4" steel pipe. Detachable and reusable!



Part #	Old No.	Description	List Price
8.710-717.0	368909P	Vent Grip Only (14" long)	\$12.51
8.904-357.0	368909PS	Grip with Side Handle	\$27.32
8.904-358.0	368920P	Side Handle with Nut	\$28.00



Part #	Old No.	Description	List Price
8.710-716.0	368909	Vent Grip Only (14" long) ST-9	\$14.44
8.710-719.0	368911	Grip with Side Handle	\$25.20
8.710-720.0	368920	Side Handle with Nut	\$12.52

MV Lance Handle



- Use on all 1/4" lances
- Easily positioned without removal of nozzle

Part #	Old No.	Description	List Price
8.704-162.0	109873	1/4" Lance Handle	\$12.47

X-Jet Long Range Nozzle



8.710-474.0

- Projects water and chemical up to 40'
- Chemicals bypass pump, lance, hose and gun for damage protection
- Includes 15' hose with in-line shut-off valve and color-coded proportioners

Part #	Old No.	Description	PSI	List Price
8.710-474.0*	360103	X-Jet Long Range Nozzle	2000-3000	\$250.47
8.710-475.0*	360104	X-Jet Long Range Nozzle	3000-4000	\$255.65
8.710-473.0	360102	M5 X-Jet Variable Fan Long Range Nozzle	2000-3000	\$297.05

*Includes Close Range Nozzle



Fiberglass Telescoping Wands

High-quality telescoping wand reaches up to 24', three sizes to choose from. Lightweight and balanced under pressure.



- **PSI: 4000**
- **GPM: 10.5**
- **Temperature: 195°F**
- 6'-12' wand shown



Belt and pole clamp

Part #	Old No.	Description	List Price
8.710-589.0	368090	6'-12'	\$200.85
8.710-590.0	368091	6'-18'	\$217.08
8.710-591.0	368092	6'-24'	\$271.55
8.700-059.0	056008	Strap and Belt Shoulder Harness	\$49.89
8.711-324.0		Gutter Cleaning Attachment	\$10.76
Replacement Guns			
8.723-896.0		TS12 Replacement Gun	\$44.45
8.710-595.0	368098	TS18 Replacement Gun	\$44.25
8.739-434.0	368099	TS24 Replacement Gun	\$45.07

Gutter Cleaner Attachment

Easily quick connect to any lance or extension wand to clean gutters or hard to reach areas. Angle improves reach and expands cleaning capabilities.



- **PSI: 3500**
- **Temperature: 200°F**
- Zinc-plated
- Inlet 1/4" M plug
- Inlet 1/4" F QC

Part #	Description	List Price
8.711-324.0	1/4" Nipple x 1/4" QC	\$10.76

Adjustable Nozzle Holder



- **PSI: 5700**
- **GPM: 10**
- **Temperature: 300°F**
- Perfect for cleaning hard-to-reach areas like inside containers or gutters
- Nozzle position locks with pressure
- Stainless-steel
- 1/4" female inlet

Part #	Description	List Price
8.749-905.0	Outlet 1/4" FNPT	\$68.67
8.749-906.0	Outlet 1/4" Male	\$70.02

Hobby Gun, Lance and Hose

Don't turn away hobby-unit owners. Complete replacement hose, gun and lance!



8.711-285.0

9.802-223.0

Part #	Old No.	Description	List Price
9.802-223.0	4-011137	Insulated Lance w/ Gun	\$54.68
9.802-220.0	4-011106	Lance w/ Coupler (Not Shown)	\$27.00
8.711-285.0	4-011105	Lance w/ #3 Hi/Low Varifan Nozzle	\$32.60
8.711-531.0	4-02010025M	1/4" x 25' Thermoplastic t, 22mm both ends	\$45.70

NOTE: See page 23 for more Hobby Hose

Spray-Flex™ Flex Wand

Gives easy access to difficult spots, great for cleaning engines, roofs, eaves or underneath almost anything! Holds its shape under pressure.



- **PSI: 3000 and 5000**
- **Temperature: 190°F**
- 90° flexibility

Part #	Old No.	PSI	List Price
8.710-597.0	368117	3000	\$112.27
8.710-596.0	368116	5000	\$133.90

Flex Lances

Flexes a full 180° and returns, saving broken wand repairs.



- **PSI: 2500**
- **Temperature: 200°F**
- Prevents bent lances and broken hose
- Industrial-grade polyurethane flex section
- Perfect for self-serve car wash bays
- 1/4" galvanized pipe end sections

Part #	Old No.	Description	List Price
8.710-598.0	368118	18", 1/4" MPT x 1/4" MPT	\$30.23
8.710-603.0	368121	21", 1/4" MPT x 1/8" FPT	\$42.85
8.710-604.0	368124	24", 1/4" MPT x 1/8" FPT	\$44.35

Kew Replacement Accessories



- **PSI: 4000**
- **GPM: 10.5**
- **Temperature: 300°F**
- 3/8" F inlet
- Bayonet quick coupler outlet

Iride Kew Style

Part #	Old No.	Description	List Price
8.710-427.0	353065	Iride Kew Style	\$80.11
8.704-173.0	109950	Unitized Valve	\$25.37
8.704-174.0	109960	Trigger Seal Kit	\$3.21



Bayonet Plug

- 416 stainless-steel plug attaches any 1/4" lance to Kew Guns

Part #	Old No.	Description	List Price
8.710-903.0	373069	Stainless-Steel Plug w/ Set Back Threads	\$36.23

Pressure Washer Accessory Kit



Kit 1 includes:

- Teflon tape
- Hose, 3000 PSI 3/8 x 50', R1, SoxSw
- QC nozzle, Stainless-steel 1/4" #4.0x15
- Coupler, 3/8" female brass
- Wand, 18" M22 x 1/4" QC
- Gun, S2 3/8" inlet, lance w/ M22 coupler

Kit 2 includes:

- Teflon tape
- Hose, 5000 PSI 3/8 x 50', R2, SoxSw
- QC nozzle, Stainless-steel 1/4" #4.0x15
- Coupler, 3/8" female brass
- Wand, 18" M22 x 1/4" QC
- Gun, S2 3/8" inlet, lance w/ M22 coupler

Part #	Description	List Price
8.903-454.0	Pressure Washer Accessory Kit 1	\$245.30
8.903-455.0	Pressure Washer Accessory Kit 2	\$272.21

Replacement Accessories



- **PSI: 4000**
- **Temperature: 300°F**
- M22 – 1 O-ring inlet (standard)
- M22 – 2 O-ring outlet (extended)

Part #	Old No.	Description	List Price
8.710-428.0	353070	Astra Style, 10.5 GPM	\$60.50

Maintenance Kits

8.704-173.0	109950	Unitized Valve	\$25.37
8.704-174.0	109960	Trigger Seal Kit	\$3.21

Extended Twist Seal Coupler



- **PSI: 3600**
- **GPM: 11**
- **Temperature: 300°F**
- Double O-ring seal
- Machined-brass body
- High-impact plastic knob

Part #	Old No.	Description	List Price
8.709-535.0	331215	Coupler – 1/4" FPT x 22 mm F	\$9.42
8.709-555.0	331315	Plug – 1/4" FPT x 22 mm M	\$5.18

Tip Retainer



- 18 mm thread
- Fits vent grip lance
- See tip jet nozzles in nozzle section

Part #	Old No.	Description	List Price
8.710-901.0	373065	Tip Retainer	\$6.47

Tip-Jet Nozzle System



Tip-Jet Tips

List Price
\$14.96

"Tip-Jet" Nozzle Systems are versatile nozzling systems for everyday or specialized applications. Also on pages 48 and 128.

- **PSI: Up to 4000**
- Neat and simple tip change
- Hardened stainless-steel tips with vanes
- Strainers available
- Body components available in brass, zinc-plated steel or stainless-steel

Orifice Size	0° Part #	0° Old No.	15° Part #	15° Old No.	25° Part #	25° Old No.	40° Part #	40° Old No.
3.0	8.708-016.0	253316	8.708-017.0	253317N	8.708-018.0	253318	–	–
4.0	8.708-019.0	253330	8.708-020.0	253331	8.708-021.0	253332	8.708-022.0	253333
4.5	8.708-023.0	253338	8.708-024.0	253339	8.708-025.0	253340	8.708-026.0	253341
5.0	8.708-027.0	253346	8.708-028.0	253348	8.708-029.0	253349	8.708-030.0	253350
5.5	8.708-031.0	253355	8.708-032.0	253357	8.708-033.0	253358	8.708-034.0	253359
6.0	8.708-035.0	253365	8.708-036.0	253367	8.708-037.0	253368	8.708-038.0	253369
6.5	8.708-039.0	253375	–	–	8.708-040.0	253377	8.708-041.0	253378
7.0	8.708-042.0	253383	8.708-043.0	253385	8.708-044.0	253386	8.708-045.0	253387
7.5	8.708-046.0	253392	8.708-047.0	253393	8.708-048.0	253394	8.708-049.0	253395
8.0	8.708-050.0	253400	8.708-051.0	253401	8.708-052.0	253402	8.708-053.0	253403
9.0	8.708-054.0	253415	8.708-055.0	253416	8.708-056.0	253417	8.708-057.0	253418
10.0	8.708-058.0	253456	8.708-059.0	253457	8.708-060.0	253458	8.708-061.0	253459

Legacy Rawhide Hose



Legacy

Superior abrasion-resistant cover hose for use with hot or cold water pressure washer

All standard 3/8" rawhide assemblies include:

- One solid end and one swivel end
- 8" molded vinyl, color-coded bend restrictors (both ends)
- Class B ORS (Oil-Resistance Standard) for longer life
- Temperature up to 275°F



Rawhide 1-Wire 4000 PSI Black Hose

• Durable wrapped finish outer cover

Part #	Old No.	Length	Temp	Working PSI	Approx wt lbs	List Price
3/8" Black Hose (wrapped)						
8.739-030.0	158265	25' x 3/8" ID	275°F	4000	6.0	\$53.62
8.901-774.0	158270	30' x 3/8" ID	275°F	4000	7.0	\$62.11
8.901-776.0	158275	40' x 3/8" ID	275°F	4000	10.0	\$81.61
8.739-031.0	158280	50' x 3/8" ID	275°F	4000	12.0	\$91.85
8.739-032.0	158285	75' x 3/8" ID	275°F	4000	17.0	\$130.81
8.739-033.0	158290	100' x 3/8" ID	275°F	4000	23.0	\$171.40
8.739-034.0	158295	150' x 3/8" ID	275°F	4000	34.0	\$250.25
8.724-037.0*		Per Foot				\$1.61

8.916-353.0	Case of 75 (of 8.739-031.0) – 3/8" x 50' Hoses	\$5,908.08
8.916-355.0	Case of 40 (of 8.739-033.0) – 3/8" x 100' Hoses	\$5,926.62

*500 ft. reel, 50 ft. incremental lengths (max three pieces)

Rawhide Smooth Cover Black Hose

Part #	Length	Temp	Working PSI	Approx wt lbs	List Price
3/8" Smooth 3000 PSI 1-Wire Hose					
8.740-216.0	25' x 3/8" ID	250°F	3000	6.0	\$74.78
8.740-217.0	50' x 3/8" ID	250°F	3000	13.0	\$129.07
8.740-218.0	75' x 3/8" ID	250°F	3000	19.0	\$191.48
8.740-219.0	100' x 3/8" ID	250°F	3000	25.0	\$242.19

3/8" Smooth 4500 PSI 2-Wire Hose

8.740-220.0	25' x 3/8" ID	250°F	4500	8.0	\$98.79
8.740-221.0	50' x 3/8" ID	250°F	4500	15.0	\$145.73
8.740-222.0	75' x 3/8" ID	250°F	4500	21.0	\$225.12
8.740-223.0	100' x 3/8" ID	250°F	4500	28.0	\$289.44

Legacy Rawhide 2-Wire 3/8" Hose

All black 2-wire Legacy Rawhide hose is now rated at 6000 PSI!

2-Wire RAWHIDE assemblies include:

- One solid end and one swivel end
- 6000 PSI rating – black
- 4500 PSI rating – blue
- 8" bend restrictors (both ends)
- Superior flexibility
- Beefed-up high-tensile steel wire braid
- Higher abrasion resistance
- New temperature up to 275°F



Rawhide 1-Wire 3000 PSI Smooth Non-Marking Hose

ANIMAL FAT-RESISTANT

Part #	Old No.	Length	Temp	Working PSI	Approx wt lbs	List Price
3/8" Smooth Yellow Hose						
8.901-800.0	158980	50' x 3/8" ID	250°F	3000	12.0	\$141.11
8.901-802.0	158985	75' x 3/8" ID	250°F	3000	17.0	\$215.28
8.901-804.0	158990	100' x 3/8" ID	250°F	3000	23.0	\$253.26
8.705-720.0*	158900	Per Foot				\$2.31

3/8" Smooth Blue Hose

8.739-148.0	158780	50' x 3/8" ID	250°F	3000	12.0	\$123.60
8.739-149.0	158785	75' x 3/8" ID	250°F	3000	17.0	\$185.93
8.739-150.0	158790	100' x 3/8" ID	250°F	3000	23.0	\$231.15
8.739-369.0	158795	150' x 3/8" ID	250°F	3000	34.0	\$360.18
8.724-371.0*	158700	Per Foot				\$2.11

3/8" Smooth Gray Hose

8.749-935.0	50' x 3/8" ID	250°F	3000	13.0	\$139.73
8.749-936.0	100' x 3/8" ID	250°F	3000	25.0	\$270.14
8.749-945.0*	Per Foot				\$2.26

1/4" Smooth Blue Hose

8.901-796.0	158880	50' x 1/4" ID	250°F	3000	8.0	\$125.24
8.901-798.0	158890	100' x 1/4" ID	250°F	3000	16.0	\$244.26
8.705-718.0*	158800	Per Foot				\$2.11

*500 ft. reel, 50 ft. incremental lengths (max three pieces)

Part #	Old No.	Length	Working Temp	Approx wt lbs	List Price
3/8" Black Hose (6000 PSI) – Wrapped					
8.739-077.0	159565	25'	275°F	9.0	\$66.45
8.739-078.0	159580	50'	275°F	17.0	\$116.58
8.739-079.0	159585	75'	275°F	25.0	\$172.86
8.739-080.0	159590	100'	275°F	33.0	\$216.08
8.739-081.0	159595	150'	275°F	48.0	\$316.58
8.724-042.0*	159300	500'	275°F		\$2.41

*450 ft. reel, 50 ft. incremental lengths (max three pieces)

3/8" Blue Hose (4500 PSI) – Smooth

8.739-229.0	154415	50'	250°F	17.0	\$179.66
8.739-231.0	154425	100'	250°F	33.0	\$307.53
8.705-651.0*	154400	Per Foot			\$3.07

*500 ft. reel, 50 ft. incremental lengths (max three pieces)



Legacy Ultima Hose

Wrapped cover hose with a smaller outside diameter for even greater flexibility!

All standard Ultima assemblies include:

- One solid end and one swivel end
- 8" molded vinyl color-coded bend restrictors (both ends)
- Wrapped impression, maximum oil-resistant tube and cover
- 50% greater flexibility
- Temperature up to 275°F



Ultima 1-Wire Black Hose (wrapped)

Part #	Old No.	Length	Temp	Working PSI	Approx wt lbs	List Price
3/8" Black Hose						
8.739-373.0	153550	15' x 3/8" ID	275°	3000	5.0	\$37.16
8.901-513.0	153560	30' x 3/8" ID	275°	3000	9.0	\$88.75
8.739-143.0	153570	50' x 3/8" ID	275°	3000	13.0	\$166.64
8.739-146.0	153595	150' x 3/8" ID	275°	3000	37.0	\$242.19
8.724-047.0	153000*	Per Foot				\$1.55

*Full Reel – 450 ft., hose only, 50 ft. incremental lengths (max three pieces)

1/2" Black Hose

8.739-420.0	155425	25' x 1/2" ID	275°	3000	7.5	\$91.13
8.739-421.0	155450	50' x 1/2" ID	275°	3000	14.0	\$158.79
8.739-422.0	155475	75' x 1/2" ID	275°	3000	21.0	\$233.91
8.739-423.0	155499	100' x 1/2" ID	275°	3000	27.0	\$286.43
8.724-067.0*	155400	Per Foot				\$2.71

*Full Reel – 350 ft., hose only, 50 ft. incremental lengths (max three pieces)

1/4" Black Hose

8.901-418.0	151025	25' x 1/4" ID	275°	3000	5.0	\$48.90
8.901-423.0	151030	30' x 1/4" ID	275°	3000	6.0	\$60.70
8.901-427.0	151050	50' x 1/4" ID	275°	3000	10.0	\$90.10
8.901-429.0	151075	75' x 1/4" ID	275°	3000	15.0	\$137.66
8.901-430.0	151090	100' x 1/4" ID	275°	3000	20.0	\$166.83
8.724-065.0*	151000	Per Foot				\$1.60

*Full Reel – 800 ft., hose only, 50 ft. incremental lengths (max three pieces)

1-Wire Custom Hose Fittings:

These hose fittings can be used with any 1-Wire Per Foot Hose.

Part #	Old No.	Custom Length	List Price
3/8" Hose			
8.724-335.0*	150232	add fitting(s) and bend restrictor	\$20.60
8.901-309.0*	150205	add fitting(s) only	\$16.20
1/2" Hose			
8.724-333.0*	150220	add fitting(s) and bend restrictor	\$23.18
8.901-321.0*	150222	add fitting(s) only	\$18.79
1/4" Hose			
8.724-313.0*	150210	add fitting(s) and bend restrictor	\$17.70
8.901-314.0*	150212	add fitting(s) only	\$15.16

*Assembly – Add to cost of custom length (labor and fittings – one solid, one swivel)

3/8" Gray Hose – Wrapped:



Part #	Description	List Price
3/8" Gray Hose – Wrapped		
8.921-617.0	3/8" x 25', 4K Gray A+ SOXSW	\$60.25
8.921-618.0	3/8" x 50', 4K Gray A+ SOXSW	\$98.30
8.921-619.0	3/8" x 75', 4K Gray A+ SOXSW	\$153.00
8.921-620.0	3/8" x 100', 4K Gray A+ SOXSW	\$190.00
8.752-156.0	3/8" Bulk, 4K Gray (FT)	\$1.70

Ultima 2-Wire Black Hose (wrapped)

Part #	Old No.	Length	Temp	Working PSI	Approx wt lbs	List Price
3/8" Black Hose, 5000 PSI						
8.739-222.0	154215	15' x 3/8" ID	275°	5000	5.75	\$46.78
8.739-223.0	154225	25' x 3/8" ID	275°	5000	8.0	\$60.75
8.739-224.0	154250	50' x 3/8" ID	275°	5000	15.0	\$113.30
8.739-225.0	154275	75' x 3/8" ID	275°	5000	22.0	\$155.78
8.739-226.0	154290	100' x 3/8" ID	275°	5000	28.0	\$210.63
8.739-227.0	154294	150' x 3/8" ID	275°	5000	42.0	\$313.12
8.724-052.0*	154000	Per Foot				\$2.10
8.754-138.0		450' x 3/8" ID, Spool				
8.916-354.0		Case of 75 (of 8.739-224.0) - 3/8" x 50 ft Hoses				\$7,179.10
8.916-356.0		Case of 40 (of 8.739-226.0) - 3/8" x 100 ft Hoses				\$7,086.40

*Full Reel – 450 ft. per reel, hose only, 50 ft. incremental lengths (max three pieces)

1/2" Black Hose, 4500 PSI

8.739-424.0	155725	25' x 1/2" ID	275°	4500	9.25	\$101.43
8.739-425.0	155750	50' x 1/2" ID	275°	4500	18.0	\$179.90
8.739-426.0	155775	75' x 1/2" ID	275°	4500	26.8	\$285.42
8.739-427.0	155790	100' x 1/2" ID	275°	4500	35.5	\$341.70
8.724-068.0*	155700	Per Foot				\$3.14

*Full Reel – 300 ft. per reel, hose only (max three pieces)

2-Wire Custom Hose Fittings:

These hose fittings can be used with any 2-Wire Per Foot Hose.

Part #	Old No.	Custom Length	List Price
3/8" Hose			
8.724-336.0*	150204	add fitting(s) and bend restrictor	\$20.60
8.901-309.0*	150205	add fitting(s) only	\$16.20
1/2" Hose			
8.724-334.0*	150224	add fitting(s) and bend restrictor	\$23.07
8.901-321.0*	150222	add fitting(s) only	\$18.79

*Assembly – Add to cost of custom length (labor and fittings – one solid MPT, one swivel MPT)

3/8" Blue Tuff-Flex 2-Wire 6000 PSI Hose



- Non-marking durable blue cover
- Red hose guard
- Smooth impression, maximum oil-resistant tube and cover
- 50% greater flexibility
- 3/8" MPT swivel x 3/8" MPT solid

Part #	Size	Temp	PSI	List Price
8.921-153.0	25' x 3/8" ID	275°F	6000	\$92.68
8.921-154.0	50' x 3/8" ID	275°F	6000	\$152.76
8.921-155.0	75' x 3/8" ID	275°F	6000	\$215.28
8.921-156.0	100' x 3/8" ID	275°F	6000	\$268.34
8.753-319.0	Per Foot			\$2.74

1/4", 3/8" and 1/2", 2-Wire Pressure Loop

The 1/4" ID pressure lines solid/swivel for most any application. The 3/8" ID pressure loops have female JIC on both ends for typical unloader connection hose. All pressure loops rate 275°F.



1/4" ID Pressure Loop

- 1/4" MPT swivel x 1/4" MPT solid
- 1/4" ID two-wire 5000 PSI
- Any length available



JIC Pressure Loop

- 1/2" female JIC swivels on each end
- 3/8" ID two-wire 6000 PSI
- 1/2" ID 4500 PSI
- Any length available

Part #	Old No.	Size	Description	List Price
8.918-180.0		16" x 1/4" ID	1/4" Pressure Loop	\$16.53
8.918-181.0		20" x 1/4" ID	1/4" Pressure Loop	\$12.73
8.918-182.0		26" x 1/4" ID	1/4" Pressure Loop	\$19.04
8.918-183.0		28" x 1/4" ID	1/4" Pressure Loop	\$16.77
8.918-184.0		30" x 1/4" ID	1/4" Pressure Loop	\$19.67
8.918-419.0		36" x 1/4" ID	1/4" Pressure Loop	\$22.15
8.918-187.0		42" x 1/4" ID	1/4" Pressure Loop	\$23.91
8.918-210.0		16" x 3/8" ID	JIC Pressure Loop	\$17.65
8.918-422.0		20" x 3/8" ID	JIC Pressure Loop	\$18.68
8.918-423.0		22" x 3/8" ID	JIC Pressure Loop	\$19.10
8.918-424.0		25" x 3/8" ID	JIC Pressure Loop	\$20.08
8.918-425.0		29" x 3/8" ID	JIC Pressure Loop	\$21.01
8.918-427.0		36" x 3/8" ID	JIC Pressure Loop	\$23.70
8.711-662.0	4-02047738	38" x 3/8" ID	JIC Pressure Loop	\$23.75
8.918-212.0		42" x 3/8" ID	JIC Pressure Loop	\$24.48
8.918-224.0		20" x 1/2" ID	JIC Pressure Loop	\$21.94
8.711-701.0	4-02067722	22" x 1/2" ID	JIC Pressure Loop	\$28.20
8.918-225.0		28" x 1/2" ID	JIC Pressure Loop	\$25.82
8.918-228.0		46" x 1/2" ID	JIC Pressure Loop	\$31.83
8.918-230.0		70" x 1/2" ID	JIC Pressure Loop	\$40.69

3/8" Blue Tuff-Flex 1-Wire 4000 PSI Hose



- Non-marking durable blue cover
- Red hose guard
- Smooth impression, maximum oil-resistant tube and cover
- 50% greater flexibility
- 3/8" MPT swivel x 3/8" MPT solid

Part #	Size	Temp	PSI	List Price
8.921-149.0	25' x 3/8" ID	275°F	4000	\$62.36
8.921-150.0	50' x 3/8" ID	275°F	4000	\$98.79
8.921-151.0	75' x 3/8" ID	275°F	4000	\$158.36
8.921-152.0	100' x 3/8" ID	275°F	4000	\$190.95
8.753-316.0	Per Foot			\$1.71

Whitewater® Combination Steam Hose



Good up to 3000 PSI / 250°F or 350 PSI / 325°F.



- Single high-tensile steel wire braid
- High temperature bend restrictors – both ends
- Seamless innertube
- Solid 3/8" or 1/2" MPT connectors – both ends (Swivel ends NOT available)
- Oil-resistant cover

Part #	Old No.	Length	List Price
3/8" Hose			
8.901-599.0	153930	30'	\$168.71
8.901-601.0	153950	50'	\$243.21
8.901-598.0	153925	25'	\$144.90
8.901-603.0	153975	75'	\$381.92
8.901-604.0	153990	100'	\$480.39
8.705-643.0	153900*	Per Foot	\$4.76

*Full Reel – 500 ft. per reel, hose only, 50 ft. incremental lengths (max three pieces)

Part #	Old No.	Length	List Price
1/2" Hose			
8.901-721.0	155625	25'	\$213.21
8.901-723.0	155650	50'	\$369.84
8.901-724.0	155675	75'	\$558.90
8.901-725.0	155690	100'	\$698.34
8.705-678.0	155600*	Per Foot	\$6.47

*Full Reel – 500 ft. per reel, hose only, 50 ft. incremental lengths (max three pieces)

Custom Lengths

Part #	Old No.	Description	List Price
3/8" Hose			
8.705-643.0	153900	per ft / hose only	\$4.76
8.901-316.0*	150215	add fitting(s) and bend restrictor	\$19.41
8.901-317.0*	150216	add fitting(s) only	\$15.89
1/2" Hose			
8.705-678.0	155600	per ft / hose only	\$6.47
8.901-327.0*	150230	add fitting(s) and bend restrictor	\$48.75
8.901-326.0*	150228	add fitting(s) only	\$19.56

*Assembly – Add to cost of custom length (labor and fittings — two solid MPT)

Pulse Hose



- 1300 PSI working pressure
- Available with either plug-end or open-flow with solid/swivel connects
- 3/8" MPT on both styles

Part #	Old No.	Description	List Price
8.711-151.0	381118	18" with Plug End	\$26.13
8.711-153.0	381124	24" with Plug End	\$30.58
8.711-155.0	381128	28" Solid/Swivel – Open	\$22.87
8.711-157.0	381136	36" Solid/Swivel – Open	\$26.91

Hobby Hose

Replacement hose for most hobby pressure washers sold by mass retailers.



- Thermoplastic cover
- Fiber-braid reinforcement
- 2250 PSI working pressure
- 9000 PSI burst pressure
- M22 x 1.5 fitting inlet
- 14mm seal cone fits Generac, Excell and Kärcher
- 15mm seal cone fits Campbell, MI-T-M

Part #	Old No.	Seal Cone	ID	Length	List Price
8.705-485.0	150245	14mm	1/4"	25'	\$41.50
8.705-487.0	150246	15mm	1/4"	25'	\$41.92
8.711-531.0	4-02010025M	22mm*	1/4"	25'	\$45.70

NOTE: See Hobby Gun and Lance on page 18.

*Both ends

Hose Bend Restrictors



- Top-quality molded fit bend restrictors
- Fits snugly to prevent kinks near the connectors
- Used on hose assemblies
- Non-slip sure fit
- Easy installation, 325°F

Part #	Old No.	Size	Description	List Price
8.705-479.0	150166	5.3"	1/4" 1 wire, Black Vinyl	\$2.23
8.705-476.0	150161	6.0"	3/8" 1 wire, Black Vinyl	\$2.12
8.705-478.0	150164	6.0"	3/8" 2 wire, Red Vinyl	\$2.43
8.705-481.0	150170	7.0"	1/2" 1 wire, Black Vinyl	\$2.79
8.705-480.0	150168	7.0"	1/2" 2 wire, Red Vinyl	\$3.78
8.705-483.0	150174	6.5"	3/8" Combo, Gray Vinyl	\$3.21
8.705-482.0*	150172	6.5"	1/2" Combo, Black Rubber	\$18.47

*Insulated rubber

Garden Hose – Apex Quality

The essential product for pressure washing.



- Rated for cold-water use
- Reinforced hose for flexibility & strength in all weather
- Assemblies complete with bend restrictor
- 5/8" or larger ID for full flow
- Choice of commercial or heavy-duty grade
- Commercial grade has machined octagonal "wrench tight" fittings

Part #	Old No.	Length	ID	Grade	Color	List Price
8.704-786.0	121315	50'	5/8"	Com	Gray	\$55.11
8.704-787.0	121319	100'	5/8"	Com	Gray	\$103.29
8.704-788.0	121332	50'	5/8"	HD	Lt. Green	\$55.27
8.704-789.0	121336	100'	5/8"	HD	Lt. Green	\$106.61
All Rubber Reinforced Hot Water (160°F) Hose						
8.704-790.0	121344	50'	5/8"	Com	Red	\$92.06
8.704-791.0	121348	50'	3/4"	Com	Red	\$131.45

See page 36 for garden hose fittings.

Sewer Hose

SUPER FLEXIBLE SEWER LINE HOSE AND COUPLINGS have small outside diameter, allowing hose and nozzles to fit through sewer line. Sewer line has super-tough poly-ether cover over ultra-flexible nylon tube. (1/8" sewer nozzle and hose will operate through many 1-1/2" lines.)

(Nozzles not included.)



- 160°F max temperature
- Nylon tube, polyether cover
- 1.5 GPM optimum flow 1/8"
- 2.5 GPM optimum flow 1/4"

Part #	Old No.	Description	List Price
1/8" Hose – 4800 PSI, 1/4" inlet / 1/8" outlet			
8.751-927.0	150960	1/8" x 25'	\$80.37
8.705-602.0	150963	1/8" x 50'	\$108.68
8.705-603.0	150964	1/8" x 100'	\$186.93
1/4" Hose – 2600 PSI, 1/4" inlet / 1/4" outlet			
8.705-607.0	150968	1/4" x 50'	\$78.56
8.705-608.0	150970	1/4" x 100'	\$169.74
1/4" Hose – 4400 PSI, 1/4" inlet / 1/4" outlet			
8.705-610.0	150972	1/4" x 50'	\$110.55
8.705-611.0	150973	1/4" x 100'	\$206.03

Orange 600 Sprayer Hose and Ribbed PVC Sprayer Hose

Braid-reinforced PVC hose designed specifically for AG/Pest control spraying applications.



- Tough ribbed cover
- Color – orange
- 600 PSI max pressure
- Bulk hose standard in 300' single length coils
- Resists abrasion and UV rays

Part #	Old No.	Description	List Price
3/8" Hose – Orange			
8.705-527.0	150630	300' Coil (Single, Uncut Length)	\$387.93
8.901-384.0	150634	50' Length (Bulk)	\$76.38
8.901-385.0	150636	100' Length (Bulk)	\$130.41
8.901-383.0	150632	Per Foot (Minimum 25')	\$1.45
8.724-335.0	150232	1-Wire Custom Hose Fitting	\$20.60
1/2" Hose – Orange			
8.705-523.0	150601	300' Coil (Single, Uncut Length)	\$525.62
8.901-377.0	150603	50' Length	\$98.01
8.901-379.0	150606	100' Length	\$189.41
8.705-524.0	150602	Per Foot (Minimum 25')	\$1.91
8.724-333.0	150220	1-Wire Custom Hose Fitting	\$23.18
3/4" Hose – Orange			
8.705-531.0	150660	300' Coil (Single, Uncut Length)	\$848.70
8.901-386.0	150660	Per Foot (Minimum 25')	\$3.26
8.901-351.0	150660	SO/SW Assy w/o Bend Restrictor	\$52.47

NOTE: All above hoses can be custom-fitted — with MPT fittings, male or female garden hose solid or swivel fittings, with or without bend restrictors, etc. Combinations are too numerous to list — CALL FOR CUSTOM ASSEMBLY PRICING!

Cold Weather Garden Hose



- Ideal for outdoor contractors
- Thermostatically controlled — heating element is activated at +/- 35°F temperature and turned off at +/- 40°F ambient temperature
- Heated hose with 110 plug
- Use only with a UL approved GFCI outlet or extension
- 5/8" – 50 ft.
- PVC material FDA-approved for potable water
- High-quality brass fittings

Part #	Description	List Price
8.749-944.0	50' Cold Weather Garden Hose	\$410.90

See page 36 for garden hose fittings.

Clear Reinforced PVC Tubing

Multi-use, industrial-grade tubing with high-resistance to chemicals, solvents and fuel.



- Reinforced with polyester cord
- Huge selection of sizes and lengths
- 4-to-1 burst safety factor

Part #	Old No.	ID x OD	WP@70°F	Roll Length	List Price
8.901-256.0	121031	1/4" x 3/8"	250	25'	\$9.42
8.901-257.0	121032	1/4" x 3/8"	250	50'	\$19.92
8.704-751.0	121033	1/4" x 3/8"	250	100'	\$36.02
8.704-752.0	121034	1/4" x 3/8"	250	300'	\$95.89
8.901-260.0	121036	3/8" x 1/2"	175	25'	\$12.73
8.901-261.0	121037	3/8" x 1/2"	175	50'	\$25.31
8.901-262.0	121038	3/8" x 1/2"	175	100'	\$46.52
8.704-753.0	121039	3/8" x 1/2"	175	300'	\$128.34
8.901-264.0	121041	1/2" x 3/4"	175	25'	\$18.99
8.901-265.0	121042	1/2" x 3/4"	175	50'	\$35.03
8.704-754.0	121043	1/2" x 3/4"	175	100'	\$63.39
8.704-755.0	121044	1/2" x 3/4"	175	300'	\$171.81
8.901-263.0		1/2"	175	per ft	\$2.02
8.901-267.0	121046	5/8" x 7/8"	175	25'	\$34.78
8.901-268.0	121047	5/8" x 7/8"	140	50'	\$67.43
8.901-269.0	121048	5/8" x 7/8"	140	100'	\$172.85
8.704-756.0	121049	5/8" x 7/8"	140	300'	\$486.45
8.901-266.0		5/8"	140	per ft	\$5.90
8.901-271.0	121051	3/4" x 1"	140	25'	\$73.07
8.901-272.0	121052	3/4" x 1"	140	50'	\$146.97
8.704-757.0	121053	3/4" x 1"	140	100'	\$109.71
8.704-758.0	121054	3/4" x 1"	140	300'	\$323.96
8.901-270.0		3/4"	140	per ft	\$3.36
8.901-273.0	121059	1" x 1 1/4"	75	25'	\$73.59
8.901-274.0	121060	1" x 1 1/4"	75	50'	\$144.90
8.901-275.0	121061	1" x 1 1/4"	75	100'	\$283.59
8.704-759.0	121063	1" x 1 1/4"	75	200'	\$588.92
8.901-276.0		1"	75	per ft	\$3.42

See page 36 for hose clamps.

Crimp Fittings

Part #	Description	Hose	List Price
8.724-027.0	3/8" MPT, Solid	3/8"	\$3.31
8.724-028.0	3/8" MPT, Swivel	3/8"	\$6.48
8.724-029.0	1/2" FJIC, Solid	3/8"	\$5.85
8.706-759.0	3/8" FPT, Swivel	3/8"	\$13.20

"Field" Attachable Couplings



Design and build your own hose or adapt and repair hose in the field (no crimper required).

Couplings for 1-Wire Braid Hose

Part #	Old No.	ID x MPT	List Price
8.705-493.0	150502	1/4" x 1/4" – Solid	\$8.64
8.705-495.0	150505	1/4" x 1/4" – Swivel	\$17.03
8.705-496.0	150510	3/8" x 1/4" – Solid	\$11.39
8.705-497.0	150511	3/8" x 3/8" – Solid	\$9.22
8.705-498.0	150513	3/8" x 3/8" – Swivel	\$17.39
8.705-499.0	150515	1/2" x 3/8" – Solid	\$26.81
8.705-500.0	150516	1/2" x 1/2" – Solid	\$13.87
8.705-501.0	150518	1/2" x 1/2" – Swivel	\$20.80

Couplings for 2-Wire Braid Hose

Part #	Old No.	ID x MPT	List Price
8.705-502.0	150532	1/4" x 1/4" – Solid	\$11.02
8.705-503.0	150535	1/4" x 1/4" – Swivel	\$18.99
8.705-504.0	150540	3/8" x 1/4" – Solid	\$21.79
8.705-505.0	150541	3/8" x 3/8" – Solid	\$12.01
8.705-506.0	150543	3/8" x 3/8" – Swivel	\$19.52
8.705-507.0	150546	1/2" x 1/2" – Solid	\$17.34
8.705-508.0	150548	1/2" x 1/2" – Swivel	\$40.93

Clear PVC Tubing



- "Box Pak" 100 ft.
- 25°F to 150°F
- Very flexible, non-reinforced
- Packaged in self-dispensing box

Part #	Old No.	ID	OD	WP @ 70°F	List Price
8.901-279.0	121070	1/4"	3/8"	55	\$20.08
8.704-766.0	121106	1/2"	5/8"	30	\$43.37

Flex Line Bypass / Supply Line Hose

Industrial PVC hose with black seamless inner tube, polyester braid reinforced tough outer cover. Excellent for use as supply lines or bypass lines. Typically used for air hose.



- Looks and feels like rubber
- Smooth dirt- and oil-resistant finish
- Super flexible
- Abrasion-resistant cover
- Burst-rated three-times WP

Part #	Old No.	ID x OD	WP@70°F	Roll Length	List Price
Red Cover, heavy wall					
8.901-281.0	121081	3/8" x .634"	300	50'	\$54.54
8.704-762.0	121084	3/8" x .634"	300	500'	\$417.11
8.901-282.0	121087	1/2" x .792"	250	50'	\$50.09
8.704-764.0	121090	1/2" x .792"	250	500'	\$526.33
8.901-284.0	121097	3/4" x 1.14"	160	50'	\$107.64
8.704-765.0	121099	3/4" x 1.14"	160	300'	\$624.11
Blue Cover, standard wall					
8.704-779.0	121160	1/4" x .475"	250	100'	\$53.51

Connector Hose – 2'-10'

Connector hose comes with one solid / one swivel end.



3/8" Ultima – 2-wire 5000 PSI			3/8" Ultima – 2-wire 5000 PSI		
w/o Bend Restrictors			with Bend Restrictors		
Part #	Length	List Price	Part #	Length	List Price
8.918-271.0	2'	\$18.19	8.918-272.0	2'	\$20.03
8.918-273.0	3'	\$19.80	8.918-275.0	3'	\$23.86
8.918-276.0	4'	\$21.16	8.918-277.0	4'	\$22.51
8.918-278.0	5'	\$22.56	8.918-279.0	5'	\$27.22
8.918-280.0	6'	\$24.41	8.918-281.0	6'	\$28.31
8.918-282.0	7'	\$25.62	8.918-283.0	7'	\$29.76
8.918-284.0	8'	\$28.93	8.918-285.0	8'	\$29.08
8.918-286.0	9'	\$31.00	8.918-287.0	9'	\$31.15
8.918-288.0	10'	\$33.11	8.918-289.0	10'	\$37.57

3/8" Ultima – 1-wire 4000 PSI			3/8" Ultima – 1-wire 4000 PSI		
w/o Bend Restrictors			with Bend Restrictors		
Part #	Length	List Price	Part #	Length	List Price
8.918-253.0	2'	\$15.99	8.918-254.0	2'	\$17.70
8.918-255.0	3'	\$16.87	8.918-256.0	3'	\$18.42
8.918-257.0	4'	\$18.04	8.918-258.0	4'	\$20.13
8.918-259.0	5'	\$20.03	8.918-260.0	5'	\$23.96
8.918-261.0	6'	\$21.89	8.918-262.0	6'	\$22.98
8.918-263.0	7'	\$23.08	8.918-264.0	7'	\$24.01
8.918-265.0	8'	\$25.20	8.918-266.0	8'	\$25.88
8.918-267.0	9'	\$26.81	8.918-268.0	9'	\$31.41
8.918-269.0	10'	\$29.76	8.918-270.0	10'	\$30.33

1/2" Ultima – 2-wire 5000 PSI			1/2" Ultima – 2-wire 5000 PSI		
w/o Bend Restrictors			with Bend Restrictors		
Part #	Length	List Price	Part #	Length	List Price
8.918-292.0	2'	\$22.20	8.918-293.0	2'	\$23.44
8.918-294.0	3'	\$26.60	8.918-295.0	3'	\$26.96
8.918-296.0	4'	\$30.12	8.918-297.0	4'	\$30.38
8.918-298.0	5'	\$34.16	8.918-299.0	5'	\$33.74
8.918-300.0	6'	\$38.45	8.918-418.0	6'	\$36.79
8.918-301.0	7'	\$36.54	-	-	-
8.918-302.0	8'	\$45.28	-	-	-
8.918-303.0	9'	\$49.11	-	-	-
8.918-304.0	10'	\$52.94	8.918-305.0	10'	\$50.77

1/4" Ultima – 1-wire 4000 PSI			1/4" Ultima – 1-wire 4000 PSI		
w/o Bend Restrictors			with Bend Restrictors		
Part #	Length	List Price	Part #	Length	List Price
8.918-240.0	2'	\$16.20	-	-	-
8.918-241.0	3'	\$17.13	-	-	-
8.918-242.0	4'	\$38.66	-	-	-
8.918-243.0	5'	\$19.98	8.918-244.0	5'	\$20.34
8.918-245.0	6'	\$22.61	8.918-246.0	6'	\$21.94
8.918-247.0	7'	\$23.39	-	-	-
8.918-248.0	8'	\$24.43	8.918-249.0	8'	\$23.91
8.918-250.0	9'	\$28.51	-	-	-
8.918-251.0	10'	\$30.12	8.918-252.0	10'	\$28.82

Connector Hose / Car Wash Bay Hose – 12'-25'

All car wash bay hoses come with solid male pipe on both ends.



3/8" Ultima – 1-wire 4000 PSI			3/8" Ultima – 1-wire 4000 PSI		
w/o Bend Restrictors			with Bend Restrictors One End		
Part #	Length	List Price	Part #	Length	List Price
8.918-333.0	12'	\$30.22	8.919-123.0	12'	\$35.40
8.918-334.0	13'	\$31.57	8.918-335.0	13'	\$30.69
8.918-336.0	14'	\$34.21	8.918-337.0	14'	\$34.26
8.918-338.0	15'	\$36.02	8.918-339.0	15'	\$39.02
8.918-340.0	16'	\$37.10	8.918-341.0	16'	\$41.66
8.918-342.0	17'	\$39.80	8.918-343.0	17'	\$39.12
8.918-344.0	18'	\$41.66	8.918-345.0	18'	\$40.78
8.918-346.0	19'	\$38.40	8.918-347.0	19'	\$42.44
8.918-348.0	20'	\$45.07	8.918-349.0	20'	\$43.78
8.918-350.0	21'	\$47.04	8.918-351.0	21'	\$45.59
8.918-352.0	22'	\$43.21	8.918-353.0	22'	\$47.25
8.918-354.0	23'	\$44.87	8.918-355.0	23'	\$48.90
8.918-356.0	24'	\$46.58	8.918-357.0	24'	\$50.61
8.918-358.0	25'	\$54.65	8.918-359.0	25'	\$52.27

1/4" Ultima – 1-wire 4000 PSI			1/4" Ultima – 1-wire 4000 PSI		
w/o Bend Restrictors			with Bend Restrictors One End		
Part #	Length	List Price	Part #	Length	List Price
8.918-306.0	12'	\$26.65	8.918-307.0	12'	\$26.75
8.918-308.0	13'	\$24.12	8.918-309.0	13'	\$28.15
8.918-310.0	14'	\$28.88	8.918-311.0	14'	\$33.48
8.918-312.0	15'	\$30.48	8.918-313.0	15'	\$30.95
8.918-314.0	16'	\$32.03	8.918-315.0	16'	\$32.34
8.918-316.0	17'	\$33.64	8.918-317.0	17'	\$33.74
8.918-318.0	18'	\$35.19	8.918-319.0	18'	\$35.09
8.918-320.0	19'	\$32.45	8.918-321.0	19'	\$36.54
8.918-322.0	20'	\$38.35	8.918-323.0	20'	\$37.88
8.918-324.0	21'	\$39.95	8.918-174.0	21'	\$39.49
8.918-325.0	22'	\$36.64	8.918-326.0	22'	\$40.68
8.918-327.0	23'	\$38.04	8.918-328.0	23'	\$42.07
8.918-329.0	24'	\$44.66	8.918-330.0	24'	\$43.47
8.918-331.0	25'	\$40.83	8.918-332.0	25'	\$44.87

3/8" Blue – 1-wire 4000 PSI			3/8" Blue – 1-wire 4000 PSI		
w/o Bend Restrictors			with Bend Restrictors One End		
Part #	Length	List Price	Part #	Length	List Price
8.918-360.0	12'	\$37.10	8.918-361.0	12'	\$41.81
8.918-362.0	13'	\$42.64	8.918-363.0	13'	\$44.04
8.918-364.0	14'	\$41.30	8.918-365.0	14'	\$46.58
8.918-366.0	15'	\$43.63	8.918-367.0	15'	\$48.70
8.919-124.0	16'	\$47.61	8.918-368.0	16'	\$51.08
8.918-369.0	17'	\$52.73	8.918-370.0	17'	\$46.68
8.918-371.0	18'	\$50.66	8.918-372.0	18'	\$56.67
8.918-373.0	19'	\$53.04	8.918-374.0	19'	\$57.55
8.918-375.0	20'	\$55.42	8.918-376.0	20'	\$61.63
8.918-377.0	21'	\$57.75	8.918-378.0	21'	\$62.88
8.918-379.0	22'	\$60.13	8.918-380.0	22'	\$65.26
8.918-381.0	23'	\$67.79	8.918-382.0	23'	\$67.59
8.918-383.0	24'	\$64.84	8.918-384.0	24'	\$69.97
8.918-385.0	25'	\$72.86	8.918-386.0	25'	\$72.29

1/4" Blue – 1-wire 4000 PSI			1/4" Blue – 1-wire 4000 PSI		
w/o Bend Restrictors			with Bend Restrictors One End		
Part #	Length	List Price	Part #	Length	List Price
8.918-387.0	12'	\$37.00	8.918-388.0	12'	\$39.80
8.918-389.0	13'	\$37.42	8.918-390.0	13'	\$42.07
8.918-391.0	14'	\$41.61	8.918-392.0	14'	\$44.35
8.918-393.0	15'	\$41.92	8.918-394.0	15'	\$46.58
8.918-395.0	16'	\$46.16	8.918-396.0	16'	\$49.27
8.918-397.0	17'	\$46.47	8.918-398.0	17'	\$51.08
8.918-399.0	18'	\$48.75	8.918-400.0	18'	\$53.35
8.918-401.0	19'	\$50.97	8.918-402.0	19'	\$55.53
8.918-403.0	20'	\$53.30	8.918-404.0	20'	\$57.86
8.918-405.0	21'	\$55.58	8.918-406.0	21'	\$60.08
8.918-407.0	22'	\$57.86	8.918-408.0	22'	\$62.31
8.918-409.0	23'	\$60.13	8.918-410.0	23'	\$64.58
8.918-411.0	24'	\$62.36	8.918-412.0	24'	\$66.81
8.918-413.0	25'	\$64.69	8.918-414.0	25'	\$69.09

Legacy Stackable Hose Reels

Hose reels built specifically for contractors who require flexibility on a job site. Stackable reels are supported on both sides of the central hub to accommodate more aggressive applications, such as trailer-mounted.

Specifications:

- Integrated frame adds protection and stacking ability
- Stacked up to 3 high
- Heavy-duty powder-coated steel or stainless steel
- Reel and swivel rated up to 6000 PSI and 350°F
- Modular design is able to configure for various needs
- Reversible hand-crank and swivel

Part #	Description	Length	List Price
9.801-767.0	Stackable Hose Reel, Mild Steel	100'	\$350.00
9.801-768.0	Stackable Hose Reel, Mild Steel	200'	\$380.00
9.801-769.0	Stackable Hose Reel, Stainless Steel	100'	\$720.00
9.801-770.0	Stackable Hose Reel, Stainless Steel	200'	\$810.00

NOTE: Hose not included

Part #	Description	List Price
8.923-415.0	Hose Guide, 100' Reel	\$97.00
8.923-427.0	Hose Guide, 200' Reel	\$105.00
8.923-416.0	Hose Reel Riser	\$155.00
8.923-918.0	Reel Cart System	\$155.00



200' Mild Steel Stackable Hose Reel

100' Mild Steel Stackable Hose Reel



Stainless Steel Stackable Hose Reel

200' Mild Steel Stackable Hose Reel with Optional Hose Guide and Hose Reel Riser

200' Mild Steel Stackable Hose Reels with Optional Reel Cart System and Hose Guide

Options



Reel Cart System

Hose Reel Riser

Hose Guide

*Patent D739,715S and other Patents Pending

Legacy Hose Reels

Fully assembled and ready to use!

Legacy hose reels were designed for ease of use and durability in commercial pressure washer applications.

Offering 100' and 200' reels in both a fixed base and 360 degree rotating base. The oversized reel holds the advertised length plus leaves additional space reducing the difficulty of reeling hose. The unique extended swivel improves the hose connection and reduces hose wear and stress.



Fixed Base
Hose Reel



360° Pivot Reel

Bracket Sockets



Universal Mount



Skid Mount



Wall Mount



Base Mount

Non-Pivot Reel Brackets



Universal



90°



45°



Vertical

Specifications:

- 5000 PSI
- 325°F
- 100'- and 200'-fixed base
- 100'- and 200'-360° rotating base
- High-pressure, double-seal swivels
- Reels equipped for 3/8" hose. Easily convertible to 1/2" hose with the change to a 1/2" swivel
- 2-year warranty

Part #	Description	Length	List Price
8.750-485.0	Pivot Reel	100' x 3/8"	\$346.73
8.750-482.0	Pivot Reel	200' x 3/8"	\$386.93
8.750-476.0	Fixed Based	100' x 3/8"	\$266.33
8.750-479.0	Fixed Based	200' x 3/8"	\$279.39

NOTE: Hose not included

Part #	Description	List Price
8.919-430.0	Universal Mount	\$78.66
8.919-794.0	Skid Mount	\$104.54
8.919-437.0	Wall Mount	\$36.23
8.919-434.0	Base Mount	\$39.33
8.919-072.0	Bracket, Universal	\$56.93
8.919-445.0	Bracket, 90°	\$24.84
8.919-441.0	Bracket, 45°	\$25.88
8.919-448.0	Bracket, Vertical	\$25.88

Legacy Hose Reel Swivels



- Innovative design
- 5000 PSI
- Stainless-steel rotor
- Unique dual seal for extra long life
- 2-year warranty



- Limits bend and hose stress
- 5000 PSI
- Stainless-steel rotor
- Unique dual seal for extra long life
- 2-year warranty

Swivels

Part #	Inlet x Outlet	List Price
9.118-021.0	1/2" M x 3/8" F	\$60.03
9.118-022.0	1/2" F x 3/8" F	\$61.13
9.118-023.0	3/8" M x 3/8" F	\$59.67
9.118-024.0	3/8" F x 3/8" F	\$59.67
9.118-025.0	1/2" M x 1/2" F	\$60.24
9.118-026.0	1/2" F x 1/2" F	\$60.24
9.118-027.0	3/8" M x 1/2" F	\$59.67
9.118-028.0	3/8" F x 1/2" F	\$59.67

Extended Swivels

Part #	Inlet x Outlet	List Price
9.118-020.0	1/2" M x 3/8" F	\$67.28
9.118-029.0	1/2" F x 3/8" F	\$69.71
9.118-030.0	3/8" M x 3/8" F	\$67.74
9.118-031.0	3/8" F x 3/8" F	\$67.74
9.118-034.0	1/2" M x 1/2" F	\$68.41
9.118-035.0	1/2" F x 1/2" F	\$68.41
9.118-032.0	3/8" M x 1/2" F	\$67.74
9.118-033.0	3/8" F x 1/2" F	\$59.77

Universal Repair Kit

Part #	List Price
8.776-001.0	\$20.44



AP Hose Reels

AP hose reels have been designed to perfectly balance ruggedness and durability with affordability.



Swivel Repair Kits

Part #	Old No.	List Price
8.900-855.0	110025	\$6.13

- Flared flanges for maximum capacity
- Solid center core for maximum strength
- Rolled, beaded-edge flanges for maximum safety
- Easy mounting options for maximum versatility
- "Posi-Pin" lock prevents unwanted dereeling
- Heavy-duty powder-coated steel
- Easy access external swivel
- 4000 PSI working pressure
- Rated temperature: 225°F
- 3/8" or 1/2" inlet/outlet

Part #	Old No.	Hose Dia	Capacity (in feet)	Core Width	Flange Width	Flange Diameter	Overall Height	List Price
8.711-192.0	386188	3/8"	50	4.3	7.9	10.5	13.0"	\$105.57
9.804-067.0	386191	3/8"	100	8.7	12.2	10.5	13.0"	\$107.54
8.711-199.0	386206	3/8"	150	6.3	10.2	13.0	16.7"	\$141.71
8.711-201.0	386209	1/2"	100	6.3	10.2	13.0	16.7"	\$114.89
8.712-460.0	421043	Replacement Swivel for Part # 8.711-192.0 and 9.804-067.0						\$38.92
8.712-469.0	421063	Replacement Swivel for Part # 8.711-199.0						\$36.12
8.712-462.0	421045	Replacement Swivel for Part # 8.711-201.0						\$43.00
8.700-188.0	4-0203612	Replacement Handle						\$4.35

NOTE: Hose is not included in price. See page 25 for connector hose.



Swivel Repair Kits

Part #	Old No.	Hose Dia	List Price
8.700-287.0	075130	3/8"	\$26.55
8.700-285.0	075128	1/2"	\$23.08
8.900-855.0*	110025		\$6.13

*For Round Swivels

- Super-reinforced core — won't collapse!
- Adjustable brake for controlled reel tension
- Convenient external swivel
- Manual rewind handle included
- Solid core bolts on to flanges for extra strength
- 225°F max temperature
- Snap-lock to prevent accidental dereeling
- Bearings have oil cap for easy field maintenance
- 4000 PSI working pressure

Professional Size Reel

Part #	Old No.	Hose Dia	Capacity (in feet)	Reel Size Width	Reel Size Diameter	List Price
8.711-182.0	386174	3/8"	150	6"	18"	\$262.31
8.711-183.0	386175	3/8"	300	10"	18"	\$274.37
8.711-184.0	386176	3/8"	350	14"	18"	\$294.98
8.711-189.0	386181	1/2"	200	10"	18"	\$288.77
8.711-190.0	386182	1/2"	270	14"	18"	\$302.22
8.715-921.0	600975T	Replacement Brake for Part # 8.711-182.0 and 8.711-183.0				\$3.73

NOTE: Hose is not included in price. Interchangeable parts available. Call for pricing. See page 25 for connector hose.

Space Saver Reel

Part #	Old No.	Hose Dia	Capacity (in feet)	Reel Size Width	Reel Size Diameter	List Price
8.711-179.0	386171	3/8"	90	6"	14"	\$243.23
8.711-180.0	386172	3/8"	140	10"	14"	\$272.21
8.711-181.0	386173	3/8"	200	14"	14"	\$293.94
8.711-186.0	386178	1/2"	115	10"	14"	\$303.26
8.711-187.0	386179	1/2"	150	14"	14"	\$276.35

NOTE: Hose is not included in price. Interchangeable parts available. Call for pricing. See page 25 for connector hose.

Coxreels Hose Reels



8.711-858.0



9.802-265.0



8.723-649.0
(hose and ball stop not included)

Spring Driven Hose Reel

- Lightweight, compact design
- Adjustable drag brake
- Sturdy U-shaped frame
- Up to 4000 PSI
- Rolled edges and ribbed discs provide strength and safety
- Pro-grade heavy-duty steel
- 2-year mfg. limited warranty

Coxreels offer high performance in a very compact and lightweight hand crank or spring-driven hose reel. Perfect for mobile application and permanent floor and wall mount.

- Rated up to 4000 PSI
- -20°F to 225°F
- Adjustable drag brake
- 90° brass swivel

Part #	Old No.	Description	PSI	List Price
8.711-858.0	4-02750001	200' x 1/2" (300' x 3/8" with Adapter)	3000	\$457.32
8.711-860.0	4-02750002	100' x 3/8"	4000	\$290.45
9.802-265.0	4-02750003	150' x 3/8"	4000	\$311.55
8.711-591.0	4-020369	Handle Replacement		\$59.46
8.711-588.0	4-020366	Locking Pin Assy		\$37.47
8.723-649.0	87236490	50' x 3/8" Spring Driven	4000	\$754.99
8.705-132.0	140407	1/2" to 3/8" Adapter (for 8.711-858.0)		\$1.80
8.750-020.0		Ball Stop for 8.723-649.0		\$14.73
8.711-584.0	4-020362	Replacement Swivel, 1/2"		\$128.34
8.711-585.0	4-020363	Replacement Swivel, 3/8"		\$90.41

Quick Couplers



- Precision brass design
- Stainless-steel band for increased durability (except 1/2")
- Unrestricted free-flow
- 4000 PSI max

Brass Couplers, designed for 4000 PSI and extended durability. Affordable and rugged all in one.

Part #	Old No.	Description	List Price	Case Lot Part #	Case Price
9.802-164.0	2-2000	1/4" FPT	\$4.33	8.916-538.0 Case of 200 Couplers	\$716.88
9.802-166.0	2-2002	3/8" FPT	\$5.06	8.916-537.0 Case of 200 Couplers	\$856.96
8.707-166.0	2-20180	1/2" FPT	\$21.58		
9.802-165.0	2-2001	1/4" MPT	\$4.34	8.916-542.0 Case of 200 Couplers	\$741.24
9.802-169.0	2-2003	3/8" MPT	\$5.06	8.916-541.0 Case of 200 Couplers	\$856.96
8.707-167.0	2-20181	1/2" MPT	\$20.39		



- Zinc-plated
- Hardened steel
- 4000 PSI max

Steel Nipples, hardened steel combined with zinc yellow chromate plating holds up to the harshest environments.

Part #	Old No.	Description	List Price	Case Lot Part #	Case Price
8.707-136.0	2-2004	1/4" FPT	\$1.04	8.916-361.0 Case of 200 Nipples	\$159.39
8.707-137.0	2-20040	1/4" x 1/8" FPT	\$5.95		
9.802-170.0	2-2006	3/8" FPT	\$1.30	8.916-536.0 Case of 200 Nipples	\$202.86
8.707-165.0	2-2018	1/2" FPT	\$9.32		
8.707-139.0	2-2005	1/4" MPT	\$1.09	8.916-540.0 Case of 200 Nipples	\$144.90
9.802-171.0	2-2007	3/8" MPT	\$1.30	8.916-539.0 Case of 200 Nipples	\$172.85
8.707-164.0	2-2017	1/2" MPT	\$6.52		

Stainless-Steel Quick Couplers



- Chemical-resistant
- 303 stainless-steel
- 6000 PSI



Part #	Old No.	Description	List Price
8.707-110.0	2-2001SS	1/4" MPT Stainless-steel Couplers	\$5.87
8.707-135.0	2-2003SS	3/8" MPT Stainless-steel Couplers	\$7.36
8.707-140.0	2-20051	1/4" MPT Stainless-steel Nipples	\$2.99
8.707-152.0	2-20071	3/8" MPT Stainless-steel Nipples	\$3.91
8.707-103.0	2-2000SS	1/4" FPT Stainless-steel Couplers	\$5.87
8.707-125.0	2-2002SS	3/8" FPT Stainless-steel Couplers	\$7.42
8.707-138.0	2-20041	1/4" FPT Stainless-steel Nipples	\$2.99
8.707-144.0	2-20061	3/8" FPT Stainless-steel Nipples	\$3.91

O-Rings

O-Rings for AP, Hansen, Foster, Parker, and other quick-coupler brands.
Buna to 210°F, EPDM to 280°F and Viton to 300°F and aggressive chemicals.



QC EPDM				QC Buna				QC Viton			
Part #	Old No.	QC Size	List Price	Part #	Old No.	QC Size	List Price	Part #	Old No.	QC Size	List Price
8.900-026.0	075033	1/8"	\$0.36	8.900-027.0	075034	1/4"	\$0.34	8.702-084.0	075042	1/4"	\$0.99
9.802-098.0	075035	1/4"	\$0.26	8.702-017.0	075036	3/8"	\$0.56	8.702-088.0	075041	3/8"	\$1.34
8.900-029.0	075037	3/8"	\$0.36	8.900-030.0	075038	1/2"	\$0.36	8.900-032.0	075040	1/2"	\$1.24



Hansen Quick Connective Couplers

Built by the company that invented quick connective couplers in 1915. Designed and built to perform even in the toughest pressure washing applications.



- Precision performance
- Unrestricted bore for free flow
- Resists plug deformation when pressure spikes occur and withstands pump pulse

Pressure Rating Service

Series	W/Steel Plug PSI	W/Brass Plug PSI	W/Stainless-steel PSI
1/8"	2600	2500	4200
1/4"	5500	5200	6700
3/8"	3500	2700	6300
1/2"	2700	2200	3000
3/4"	1700	1700	1700

Part #	Old No.	Description	List Price
8.709-436.0	331010	1/8" MPT Brass Coupler Socket	\$10.61
8.709-437.0	331011	1/8" FPT Brass Coupler Socket	\$5.80
8.709-440.0	331015	1/4" MPT Brass Coupler Socket	\$8.24
8.709-442.0	331016	1/4" FPT Brass Coupler Socket	\$7.00
8.709-447.0	331020	3/8" MPT Brass Coupler Socket	\$9.06
8.709-449.0	331021	3/8" FPT Brass Coupler Socket	\$9.06
8.709-453.0	331025	1/2" MPT Brass Coupler Socket	\$13.09
8.709-454.0	331026	1/2" FPT Brass Coupler Socket	\$13.09
8.709-463.0	331045	3/4" MPT Brass Coupler Socket	\$21.10
8.709-462.0	331044	3/4" FPT Brass Coupler Socket	\$22.46
8.709-438.0	331012	1/8" Stainless-Steel MPT Coupler Socket	\$44.56
8.709-444.0	331017	1/4" Stainless-Steel FPT Coupler Socket	\$29.96
8.709-564.0	331413	3/8" Stainless-Steel FPT Coupler Socket	\$33.43
8.709-457.0	331031	1/2" Stainless-Steel FPT Coupler Socket	\$36.43
8.709-478.0	331110	1/8" MPT Plugs, Steel, Zinc-plated	\$6.37
8.709-479.0	331111	1/8" FPT Plugs, Steel, Zinc-plated	\$3.54
8.709-483.0	331115	1/4" MPT Plugs, Steel, Zinc-plated	\$1.86
8.709-484.0	331116	1/4" FPT Plugs, Steel, Zinc-plated	\$2.02
8.709-490.0	331120	3/8" MPT Plugs, Steel, Zinc-plated	\$2.38
8.709-492.0	331121	3/8" FPT Plugs, Steel, Zinc-plated	\$2.54
8.709-499.0	331125	1/2" MPT Plugs, Steel, Zinc-plated	\$4.76
8.709-500.0	331126	1/2" FPT Plugs, Steel, Zinc-plated	\$5.95
8.709-502.0	331127	3/4" MPT Plugs, Steel, Zinc-plated	\$7.14
8.709-509.0	331144	3/4" FPT Plugs, Steel, Zinc-plated	\$8.69
8.709-486.0	331117	1/4" MPT Plugs, Hardened Stainless-Steel	\$9.37
8.709-488.0	331118	1/4" FPT Plugs, Hardened Stainless-Steel	\$9.37
8.709-494.0	331122	3/8" MPT Plugs, Hardened Stainless-Steel	\$9.94
8.709-496.0	331123	3/8" FPT Plugs, Hardened Stainless-Steel	\$10.87
8.709-480.0	331112	1/2" MPT Plugs, Hardened Stainless-Steel	\$17.34
8.709-481.0	331113	1/2" FPT Plugs, Hardened Stainless-Steel	\$38.19

11,000 PSI Quick Couplers

SnapTite Quick Sockets and Plugs are precision-built for extreme high pressure.

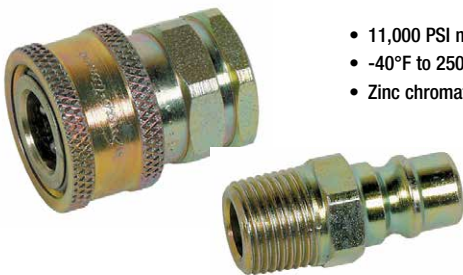

- 11,000 PSI max
- -40°F to 250°F
- Zinc chromate

Part #	Old No.	Description	List Price
8.707-115.0	2-20023	1/4" FPT Socket	\$19.04
8.707-116.0	2-200231	1/4" MPT Socket	\$61.69
9.802-167.0	2-20021	3/8" FPT Socket	\$26.65
8.707-117.0	2-20024	1/4" FPT Plug	\$9.00
8.707-121.0	2-20028	1/4" MPT Plug	\$9.11
9.802-168.0	2-20022	3/8" FPT Plug	\$9.16
8.707-120.0	2-20027	3/8" MPT Plug	\$9.63
9.804-043.0	2-0132	1/4"	\$11.39
8.706-712.0	2-01321	3/8"	\$9.83

Twist Seal Couplers

Allows U.S.-standard hose to connect to European (22mm) fittings.

- Internal O-ring seal
- Machined-brass body
- High-impact plastic knob
- 7.8 GPM max flow
- 3600 PSI max pressure
- 302°F max temperature



Part #	Old No.	Description	List Price
8.709-522.0	331205	1/4" FPT	\$6.57
8.709-530.0	331207	3/8" FPT	\$6.77
9.802-173.0	331204	1/4" MPT	\$7.61
8.709-526.0	331206	3/8" MPT	\$7.03
8.709-601.0	331710	3/8" QD Plug	\$4.86

Plugs are made of heavy-duty machined-brass for a safe and leak-free connection.



Part #	Old No.	Description	List Price
8.709-540.0	331305	1/4" FPT	\$4.03
8.709-546.0	331307	3/8" FPT	\$3.26
8.709-536.0	331304	1/4" MPT	\$3.88
8.707-185.0	331306	3/8" MPT	\$4.45

O-rings, Viton

Part #	Old No.	Description	List Price
8.704-036.0	109286	O-rings (Viton)	\$1.29

Twist Seal Couplers

Couples U.S.-standard pipe threads to 22mm European fittings found on imported pressure washers.

- Internal O-ring with back ring seal assures no-leak operation
- Oversized high-impact plastic knob
- Machined-brass body
- 7.8 GPM max flow
- 4000 max pressure
- 302°F max temperature
- 3.9 to 4.2 oz weight



Sockets

Part #	Old No.	Description	List Price
8.709-524.0	331205PA	1/4" FPT	\$11.28
8.709-531.0	331207PA	3/8" FPT	\$11.23
8.709-534.0	331209PA	1/2" FPT	\$12.01
8.709-521.0	331204PA	1/4" MPT	\$10.66
8.709-528.0	331206PA	3/8" MPT	\$10.66
8.709-533.0	331208PA	1/2" MPT	\$12.52



Plugs

Part #	Old No.	Description	List Price
8.709-542.0	331305PA	1/4" FPT	\$4.61
8.709-548.0	331307PA	3/8" FPT	\$5.69
8.709-553.0	331309PA	1/2" FPT	\$6.37
8.709-539.0	331304PA	1/4" MPT	\$4.71
8.709-551.0	331308PA	1/2" MPT	\$5.54



O-rings

Part #	Old No.	Description	List Price
8.704-036.0	109286	O-rings (Viton)	\$1.29
8.704-037.0	109287	Back Ring	\$2.23

Double Shut-Off Couplers and Plugs



- Quick disconnect without drips and leaks
- Indispensable for in-plant multiple station systems
- Machined-construction brass, zinc-plated steel or stainless-steel

Part #	Old No.	Description	PSI	List Price
8.709-556.0	331401	1/8" FPT Socket (Brass)	3000	\$12.73
8.709-557.0	331405	1/4" FPT Socket (Brass)	2700	\$19.20
8.709-558.0	331406	3/8" FPT Socket (Stl Zinc)	3700	\$26.55
8.709-559.0	331407	3/8" FPT Socket (Brass)	2200	\$27.58
8.709-560.0	331408	1/2" FPT Socket (Brass)	2250	\$40.83
8.709-561.0	331409	1/2" FPT Socket (Stainless-Steel)	4250	\$115.92
8.709-562.0	331410	3/4" FPT Socket (Brass)	2000	\$75.61
8.709-580.0	331501	1/8" FPT Plugs (Brass)	3000	\$5.64
8.709-581.0	331505	1/4" FPT Plugs (Brass)	2700	\$9.06
8.709-583.0	331507	3/8" FPT Plugs (Brass)	2200	\$10.14
8.709-584.0	331508	1/2" FPT Plugs (Brass)	2250	\$18.73



- Nitrile up to 210°F
- Use Viton for 230°F and above

Replacement O-rings

Part #	Old No.	Description	List Price
8.701-994.0	ORN013	O-ring 1/8" Nitrile	\$0.43
8.702-015.0	ORN110	O-ring 1/4" Nitrile	\$0.46
8.702-017.0	ORN112	O-ring 3/8" Nitrile	\$0.56
8.702-021.0	ORN114	O-ring 1/2" Nitrile	\$0.69
8.702-084.0	ORV110	O-ring 1/4" Viton	\$0.99
8.702-088.0	ORV112	O-ring 3/8" Viton	\$1.34
8.702-090.0	ORV114	O-ring 1/2" Viton	\$2.85
8.702-023.0	ORN115	O-ring 3/32" Nitrile (for kit 1)	\$0.85

Brass Quick Couplers

Designed for 4000 PSI and extended durability. EPDM O-rings as standard. Affordable and rugged all in one.



Part #	Description	List Price
8.750-695.0	Coupler 1/4" Socket FPT	\$3.78
8.750-696.0	Coupler 1/4" Socket MPT	\$3.78
8.750-697.0	Coupler 3/8" Socket FPT	\$4.61
8.750-698.0	Coupler 3/8" Socket MPT	\$4.66

90° Swivels

Excellent for car wash booms and hose reels. Remarkable value, comparable to best swivels made.



- Forged-brass body
- 4000 PSI
- 225°F
- Nitrile O-ring

Part #	Old No.	Description	List Price
8.712-460.0	421043	3/8" M x 3/8" F	\$38.92
8.712-461.0	421044	3/8" F x 3/8" F	\$38.55
8.712-462.0	421045	1/2" M x 1/2" F	\$43.00
8.712-463.0	421046	1/2" F x 1/2" F	\$41.40
8.712-464.0	421047	1/2" M x 3/8" F	\$36.07
8.712-469.0	421063	3/8" F x 3/4" M w/ 3/8" inside thread	\$36.12
8.900-855.0	110025	Repair Kit	\$6.13

Swivels – Right Angle



- 360° swivel rotation
- 3000 PSI max pressure (brass)
- 5000 PSI max pressure (stainless-steel)

Part #	Old No.	Description	List Price
8.712-448.0	421018	Swivel – Stainless-steel 3/8"	\$69.97
8.712-450.0	421020	Swivel – Brass 3/8"	\$39.02
8.712-449.0	421019	Swivel – Brass 1/2"	\$62.68
8.700-287.0	075143	Repair Kit – 3/8" for 421018 and 421020	\$26.55
8.700-285.0	075128	Repair Kit – 1/2" for 421019	\$23.08

Stainless-Steel, High-Pressure and Economy Brass Swivels



- 10.5 GPM max flow (stainless-steel)
- 7.8 GPM max flow (brass)
- 320°F max temperature (stainless-steel)
- 195°F max temperature (brass)
- Highly resistant to harsh chemicals
- "Live" swivel at full pressure
- 6 oz weight

Part #	Old No.	Description	PSI	List Price
8.712-456.0	421030	Swivel, Stainless-Steel – 1/4" M x F	5600	\$56.19
8.712-455.0	421025	Swivel, Stainless-Steel – 3/8" M x F	5600	\$57.68
8.712-443.0	421009	Swivel, Brass – 3/8" M x F	3600	\$14.08
8.704-096.0	109542	Repair Kit for 8.712-456.0 and 8.712-455.0		\$13.18

Gun Swivel



Made of corrosion-resistant material and stainless-steel, self-lubricated bearings, the new gun swivel offers highest-quality Swiss-made craftsmanship.



- 4000 PSI
- 250°F temperature
- 30 RPM

Part #	Old No.	Description	List Price
8.712-467.0	421057	Gun Swivel DGV – 1/4" NPTF	\$62.62
8.712-466.0	421056	Gun Swivel DGV – 3/8" NPTF	\$61.49

Swivels



- Swivels even at 3000 PSI
- Brass housing
- Stainless-steel flow-through bolt
- Close-tolerance fit ensures leakproof seal
- Teflon® ring provides free swivel

Part #	Old No.	Description	List Price
8.904-551.0	421010A	3/8" MPT x FPT*	\$21.84
8.904-552.0	421012A	3/8" FPT x FPT*	\$24.06
8.904-554.0	421015	3/8" FPT x FPT, Brass	\$25.67
8.900-764.0	109198	Seal Kit	\$4.61
8.900-765.0	109199	Rebuild Kit	\$9.63

*Long body style

Stainless-Steel Swivels



- Swivels even at 4000 PSI
- 200°F max temperature
- All stainless construction
- Teflon® swivel ring
- Rebuildable
- 3/8" in and out

Part #	Old No.	Description	List Price
8.712-446.0	421016	3/8" MPT x FPT	\$26.29
8.712-447.0	421017	3/8" FPT x FPT	\$27.58
8.900-764.0	109198	Seal Kit	\$4.61
8.900-765.0	109199	Rebuild Kit	\$9.63

Swivels – Ball Bearing

Swivels freely even at maximum pressure level noted below.



8.712-479.0



8.712-438.0

- MPT x FPT all sizes
- Brass and stainless-steel materials

Part #	Old No.	Description	PSI	List Price
8.712-438.0	421004	1/4"	2000	\$41.92
8.712-439.0	421005	1/4"	3500	\$47.71
8.712-440.0	421006	3/8"	2000	\$42.69
8.712-441.0	421007	3/8"	3500	\$48.44
8.712-479.0	421080	1/4" 90°	3500	\$65.41
8.700-263.0	075060	Repair Kit		\$15.55

Swivels – Stainless-Steel Ball Bearing



- Hardened, stainless-steel body
- Nitrile Buna seals
- 3500 PSI max pressure
- 180°F max temperature
- M x F NPT thread
- Ball-bearing design ensures free swivel action under pressure
- Suitable for extended-wear application

Part #	Old No.	Description	List Price
8.712-457.0	421034	1/4", 6.8 GPM	\$38.45
8.700-460.0	076102	Repair Kit for 8.712-457.0	\$10.71
8.712-458.0	421036	3/8", 10.6 GPM	\$41.04
8.700-459.0	076101	Repair Kit for 8.712-458.0	\$14.13
8.712-459.0	421038	1/2", 27.0 GPM	\$53.15
8.700-461.0	076103	Repair Kit for 8.712-459.0	\$14.02

COUPLERS, FITTINGS & FILTERS

Adapters – Brass



Part #	Old No.	FPT x MPT	List Price
8.705-186.0	140651	1/8" x 1/8"	\$1.40
9.803-054.0	140652	1/4" x 1/8"	\$1.55
8.705-188.0	140653	1/4" x 1/4"	\$1.97
8.705-185.0	140650	3/8" x 1/8"	\$6.21
9.804-007.0	140654	3/8" x 1/4"	\$2.37
8.705-190.0	140655	3/8" x 3/8"	\$3.11
8.705-192.0	140657	1/2" x 1/4"	\$3.31
8.705-191.0	140656	1/2" x 3/8"	\$3.21
9.802-148.0	140658	1/2" x 1/2"	\$3.00
8.705-194.0	140660	3/4" x 1/2"	\$6.05
8.705-195.0	140662	3/4" x 3/4"	\$10.97

Bushings – Brass



Part #	Old No.	MPT X FPT	List Price
9.803-564.0	140402	1/4" x 1/8"	\$0.98
8.705-129.0	140404	3/8" x 1/4"	\$1.39
9.804-015.0		3/8" x 1/8"	\$1.97
9.802-135.0	140406	1/2" x 1/4"	\$2.23
8.705-132.0	140407	1/2" x 3/8"	\$1.80
8.705-133.0	140410	3/4" x 3/8"	\$3.83
9.802-136.0	140411	3/4" x 1/2"	\$3.00

Hex Couplings – Brass



Part #	Old No.	FPT	List Price
8.705-150.0	140452	1/8"	\$1.14
8.705-151.0	140454	1/4"	\$1.55
8.705-152.0	140456	3/8"	\$2.42
8.705-153.0	140458	1/2"	\$2.99
8.705-154.0	140462	3/4"	\$6.00

Reducing Hex Couplings – Brass



Part #	Old No.	Description	List Price
8.705-155.0	140502	1/4" x 1/8" F	\$1.71
8.705-156.0	140504	3/8" x 1/4" F	\$2.12
8.705-157.0	140505	1/2" x 1/4" F	\$5.69
8.705-158.0	140506	1/2" x 3/8" F	\$5.33
8.705-159.0	140508	3/4" x 1/2" F	\$9.67

Hex Double Nipples – Brass



Part #	Old No.	Description	List Price
8.705-224.0	140752	1/8" x 1/8" M	\$1.00
9.802-108.0	140754	1/4" x 1/4" M	\$1.29
8.705-228.0	140756	3/8" x 3/8" M	\$2.06
9.803-989.0	140758	1/2" x 1/2" M	\$3.40
8.705-233.0	140762	3/4" x 3/4" M	\$6.62
8.705-234.0	140764	1" x 1" M	\$16.61

JIC Swivels



9.802-151.0

Part #	Description	List Price
9.802-153.0	1/4" Barb x 1/4" JIC FPT, Brass	\$2.74
9.802-151.0	1/2" Barb x 1/2" JIC FPT, Brass	\$4.66
9.802-152.0	3/4" Barb x 3/4" JIC FPT, Brass	\$10.40
9.802-048.0	1/2" JIC FPT x 3/8" MPT, Steel	\$5.15
8.706-315.0	1/2" JIC FPT x 1/2" MPT, Steel	\$7.19

Hex Reducing Nipples – Brass



Part #	Description	List Price	Part #	Description	List Price
8.705-225.0	1/4" x 1/8" M	\$1.55	8.705-229.0	1/2" x 1/4" M	\$4.40
8.705-223.0	3/8" x 1/8" M	\$3.42	9.803-276.0	1/2" x 3/8" M	\$3.42
8.705-227.0	3/8" x 1/4" M	\$2.38	9.803-556.0	3/4" x 1/2" M	\$6.37

Nipples – Brass



Close Nipple



Part #	Old No.	Description	List Price
8.705-201.0	2-1000	1/8" Close	\$0.60
8.705-204.0	2-1002	1/4" Close	\$0.94
8.705-211.0	2-1004	3/8" Close	\$1.35
9.802-109.0	2-1006	1/2" Close	\$1.91
8.705-220.0	2-1008	3/4" Close	\$4.50
8.705-202.0	140703	1/8" x 1-1/2"	\$1.19
8.705-203.0	140705	1/8" x 2-1/2"	\$5.23
8.705-205.0	140711	1/4" x 1-1/2"	\$1.60
8.705-206.0	140712	1/4" x 2"	\$2.12
8.705-207.0	2-1010	1/4" x 2-1/2"	\$3.47
8.705-212.0	140721	3/8" x 1-1/2"	\$2.48
8.705-213.0	140723	3/8" x 2-1/2"	\$4.19
8.705-214.0	2-10051	3/8" x 3"	\$6.05
8.705-217.0	140731	1/2" x 1-1/2"	\$3.42
8.705-218.0	140733	1/2" x 3"	\$9.16
8.705-221.0	140742	3/4" x 2"	\$6.05
8.705-222.0	140744	3/4" x 3"	\$13.30

90° Elbows – Brass



Part #	Old No.	Description	List Price
8.705-160.0	140552	1/8" FPT	\$2.43
8.705-161.0	2-1018	1/4" FPT	\$3.78
9.802-113.0	2-1019	3/8" FPT	\$4.55
9.803-265.0	2-1020	1/2" FPT	\$8.69
8.705-164.0	2-1021	3/4" FPT	\$14.96

8.705-169.0	140584	1/4" x 1/4" MPT	\$3.98
8.705-171.0	140586	3/8" x 3/8" MPT	\$6.04
8.705-173.0	140588	1/2" x 1/2" MPT	\$7.35

9.802-129.0	2-1060	1/2" JIC x 3/8" MPT	\$6.26
9.802-031.0	2-1062	1/2" JIC x 1/2" MPT	\$8.28

Reducing Elbows

8.705-165.0	2-10410	1/4" FPT x 1/8" FPT	\$7.30
8.705-166.0	140577	3/8" FPT x 1/4" FPT	\$10.92

8.705-168.0	140583	1/4" x 1/8" MPT	\$5.33
8.705-167.0	140582	3/8" x 1/8" MPT	\$9.21
8.705-170.0	140585	3/8" x 1/4" MPT	\$5.28
8.705-172.0	140587	1/2" x 3/8" MPT	\$7.09

JIC x Pipe Nipples



Part #	Size	List Price
8.706-265.0	1/2" JIC x 1/4" FPT	\$13.56
9.802-037.0	1/2" JIC x 3/8" FPT	\$3.66
9.802-036.0	1/2" JIC x 3/8" MPT	\$2.11
9.802-038.0	1/2" JIC x 1/2" MPT	\$2.47

Street Elbows – Brass



Part #	Description – 90°	List Price	Part #	Description – 45°	List Price
8.705-174.0	1/8" M x F	\$1.71	8.705-180.0	1/8" M x F	\$2.95
9.803-839.0	1/4" M x F	\$2.90	8.705-181.0	1/4" M x F	\$3.67
9.802-114.0	3/8" M x F	\$3.91	8.705-182.0	3/8" M x F	\$3.78
9.802-115.0	1/2" M x F	\$7.14	8.705-183.0	1/2" M x F	\$6.16
9.803-555.0	3/4" M x F	\$11.85	8.705-184.0	3/4" M x F	\$25.98

Extruded or Forged Tees – Brass



Part #	Description	List Price	Part #	Description	List Price
8.705-246.0	1/8" F	\$3.05	9.802-117.0	1/2" F	\$10.71
8.705-247.0	1/4" F	\$4.92	8.705-251.0	3/4" F	\$19.04
8.705-248.0	3/8" F	\$6.62			

Male Branch Tees – Brass



Part #	Description	List Price	Part #	Description	List Price
9.802-120.0	1/4"	\$7.66	8.705-255.0	1/2"	\$17.82
8.705-254.0	3/8"	\$8.49			

Street Tees – Brass



Part #	Description	List Price	Part #	Description	List Price
9.802-121.0	1/4"	\$5.18	9.802-122.0	1/2"	\$12.11
8.705-257.0	3/8"	\$6.11	8.705-259.0	3/4"	\$34.83

Female Crosses – Brass Extruded



Part #	Description	List Price	Part #	Description	List Price
8.705-196.0	1/4"	\$7.19	8.705-198.0	1/2"	\$16.15
8.705-197.0	3/8"	\$11.18	8.705-199.0	3/4"	\$56.87

Check Hose Barbs



- 1/4" MPT x 1/4" barb
- Brass body
- Buna or Viton check ball

Part #	Old No.	Description	List Price
8.904-389.0	385128	Check Hose Barb – Viton	\$14.54
8.904-390.0	385129	Check Hose Barb – Buna	\$22.87

JIC Nipples – Brass



9.802-128.0



8.706-894.0

Part #	Description	List Price
8.706-872.0	1/2" JIC x 1/4" MPT	\$4.19
9.802-127.0	1/2" JIC x 3/8" MPT	\$3.14
9.802-128.0	1/2" JIC x 1/2" MPT	\$3.42
8.706-877.0	1/2" JIC x 3/4" MPT	\$6.99
8.706-894.0	1/2" JIC x 1/2" FPT	\$3.98
8.706-895.0	1/2" JIC x 3/8" FPT	\$4.86
8.706-896.0	1/2" JIC x 1/4" FPT	\$5.00
8.706-897.0	1/2" JIC x 3/4" FPT	\$7.04
8.706-899.0	3/4" JIC x 3/4" Pipe MPT	\$10.45
8.706-971.0	1/2" JIC x 3/4" GHF	\$10.82

Hose Barbs – Brass



90° Barb x MPT



Barb x MPT

Part #	Old No.	Barb x MPT – 90°	List Price
9.802-142.0	140369	1/4" x 1/8"	\$3.73
9.802-143.0	140370	1/4" x 1/4"	\$3.57
8.705-118.0	140371	3/8" x 1/4"	\$3.73
8.705-119.0	140372	3/8" x 3/8"	\$4.66
8.705-120.0	140374	3/8" x 1/2"	\$7.88
8.705-121.0	140375	1/2" x 1/4"	\$6.11
8.705-122.0	140376	1/2" x 3/8"	\$7.04
8.705-123.0	140377	1/2" x 1/2"	\$7.56
8.705-125.0	140379	5/8" x 3/8"	\$5.64
8.705-126.0	140384	5/8" x 1/2"	\$6.73
Barb x MPT			
8.705-097.0	140350	1/8" X 1/4"	\$2.64
9.802-137.0	140352	1/4" X 1/8"	\$1.09
9.802-138.0	140354	1/4" x 1/4"	\$1.29
8.705-102.0	140355	1/4" x 3/8"	\$2.32
8.705-108.0	140361	1/4" x 1/2"	\$4.09
8.705-098.0	140351	3/8" x 1/8"	\$1.45
8.705-104.0	140357	3/8" x 1/4"	\$1.45
8.705-105.0	140358	3/8" x 3/8"	\$2.07
8.705-103.0	140356	3/8" x 1/2"	\$4.74
8.705-100.0	140353	3/8" x 3/4"	\$7.45
8.705-110.0	140363	1/2" x 1/4"	\$1.71
8.705-106.0	140359	1/2" x 3/8"	\$2.12
8.705-109.0	140362	1/2" x 1/2"	\$3.11
8.705-111.0	140364	1/2" x 3/4"	\$4.86
8.705-107.0	140360	5/8" x 3/8"	\$2.59
9.802-140.0	140365	5/8" x 1/2"	\$3.26
8.705-113.0	140366	5/8" x 3/4"	\$7.45
8.705-114.0	140367	3/4" x 1/2"	\$3.47
8.705-115.0	140368	3/4" x 3/4"	\$5.18
Barb x FPT			
8.706-949.0		1/4" X 1/4"	\$2.28

Push-N-Lock Barbs



- Normally requires no clamps

Part #	Old No.	Barb x MPT	List Price
8.705-069.0	140252	1/4" x 1/8"	\$1.35
8.705-070.0	140254	1/4" x 1/4"	\$1.81
8.705-071.0	140255	1/4" x 3/8"	\$3.21
8.705-072.0	140256	3/8" x 1/8"	\$2.43
8.705-073.0	140257	3/8" x 1/4"	\$1.97
8.705-074.0	140258	3/8" x 3/8"	\$2.54
8.705-075.0	140259	3/8" x 1/2"	\$4.30
8.705-076.0	140260	3/8" x 3/4"	\$13.82
8.705-077.0	140261	1/2" x 1/4"	\$4.35
9.802-156.0	140262	1/2" x 3/8"	\$3.57
8.705-079.0	140263	1/2" x 1/2"	\$4.19
8.705-080.0	140264	1/2" x 3/4"	\$8.54
8.705-081.0	140265	5/8" x 3/8"	\$12.99
8.705-082.0	140266	5/8" x 1/2"	\$7.30
8.705-083.0	140267	5/8" x 3/4"	\$9.21
8.705-084.0	140268	3/4" x 1/2"	\$7.56
8.705-085.0	140269	3/4" x 3/4"	\$7.76
Barb x Barb			
8.705-064.0	140200	1/4" x 1/4"	\$2.28
8.705-065.0	140204	3/8" x 3/8"	\$2.59
8.705-066.0	140208	1/2" x 1/2"	\$4.09
8.705-067.0	140210	5/8" x 5/8"	\$6.26
8.705-068.0	140212	3/4" x 3/4"	\$6.88

Barb x Barb

Swivel Hose Barbs – Low Pressure



- 300 PSI max pressure
- 210°F max temperature
- Brass MPT base with steel hose barb
- Swivel easily at low pressure to eliminate twists and tangles in chemical or water lines

Part #	Old No.	Description	List Price
8.705-050.0	140079	1/4" x 1/4"	\$5.54
8.705-052.0	140081	3/8" x 3/8"	\$6.42
8.705-053.0	140083	1/2" x 1/2"	\$8.54

Orificed Hose Barb



- Inexpensive way to create suction on inlet side of pump
- Used in-line from float tank to pump
- One-piece, machined-brass
- 3/8" MPT x 5/8" barb
- Standard orifice 5/32" — drill up to 3/8" to fit your need

Part #	Old No.	Description	List Price
8.705-093.0	140320	Orificed Hose barb	\$4.40

Drain Cocks



Part #	Old No.	Description	List Price
8.705-060.0	140125	1/4" Fuel Drain w/ Tee Handle	\$2.69
8.705-061.0	140127	1/4" Fuel Drain w/ Barb and Tee Handle	\$9.57

Hex Head Plugs



Part #	Old No.	Description	List Price
8.705-236.0	140802	1/8"	\$0.59
8.705-238.0	140804	1/4"	\$0.92
8.705-240.0	140806	3/8"	\$1.50
9.803-673.0	140808	1/2"	\$2.48
8.705-244.0	140810	3/4"	\$4.09

Hex Socket Head Plugs



Part #	Old No.	Description	List Price
9.803-051.0	140802A	1/8"	\$0.67
9.802-124.0	140804A	1/4"	\$0.94
8.705-241.0	140806A	3/8"	\$1.55
8.705-243.0	140808A	1/2"	\$2.48

Pipe Thread Hex Nuts



Part #	Old No.	Description	List Price
8.705-041.0	140062	1/8"	\$1.60
8.705-042.0	140064	1/4"	\$2.02
8.705-043.0	140065	3/8"	\$1.81
8.705-044.0	140067	1/2"	\$2.02
8.705-045.0	140070	3/4"	\$5.85

Garden Hose Fittings

- MGH = male garden hose
- FGH = female garden hose
- Heavy-duty, machined-brass fittings



8.901-292.0



8.705-034.0



8.709-460.0



9.804-016.0



9.802-145.0



8.705-087.0

Part #	Old No.	Description	List Price
--------	---------	-------------	------------

Swivel Fittings – 3/4" FGH

8.705-032.0	140050	1/4" MPT	\$8.18
8.901-292.0	140056	3/8" MPT	\$9.57
8.901-291.0	140051	1/2" MPT	\$10.56
8.705-033.0	140052	1/2" FPT (S-1)	\$3.73
8.705-034.0	140054	3/4" FPT (S-2)	\$4.92
8.705-035.0	140055	3/4" FGH (S-3)	\$5.80
8.705-008.0	140002	1/2" Barb	\$4.50
8.705-009.0	140004	5/8" Barb	\$4.61
8.705-010.0	140006	3/4" Barb	\$5.90

Garden Hose Quick Couplers

8.709-460.0	331040	Female Hose Coupler	\$13.92
8.709-508.0	331140	Male Hose Plug	\$6.05

Garden Hose Accessories

8.705-016.0	140020	Garden Hose Washer	\$0.28
9.804-016.0	140015	Filter Screen Washer (30-mesh)	\$0.53

Solid Fittings

8.705-024.0	140036	3/4" MGH x 3/8" MPT	\$5.59
9.802-145.0	140038	3/4" MGH x 1/2" MPT	\$6.37
8.705-026.0	140040	3/4" MGH x 3/4" MPT	\$4.50
8.705-019.0	140028	3/4" FGH x 1/2" FPT	\$6.37
8.705-020.0	140030	3/4" FGH x 3/4" FPT	\$5.23
8.705-022.0	140032	3/4" FGH x 1/2" MPT	\$7.45
8.705-023.0	140034	3/4" FGH x 3/4" MPT	\$5.12
8.705-018.0	140026	3/4" FGH x 3/4" FGH (Stainless-Steel)	\$5.85

Hose Barb Fittings

8.705-086.0	140301	3/8" Barb x 3/4" MGH	\$5.28
8.705-087.0	140303	1/2" Barb x 3/4" MGH	\$4.35
8.705-088.0	140305	5/8" Barb x 3/4" MGH	\$4.55
8.705-089.0	140307	3/4" Barb x 3/4" MGH	\$4.50
8.705-091.0	140317	3/8" Barb x 3/4" FGH	\$4.97
8.705-092.0	140319	1/2" Barb x 3/4" FGH	\$4.40
8.705-094.0	140321	5/8" Barb x 3/4" FGH	\$4.92
8.705-095.0	140323	3/4" Barb x 3/4" FGH	\$4.92

Hose Clamps

WARNING: LOW-PRESSURE USE ONLY!

Not for use on pressure washer discharge hose.



- Stainless-steel band and housing
- Worm gear tensions



- Nylon "Speedi-Clamp" tightens with a snap
- Releases with a twist

Part #	Old No.	Band	OD	Min-Max	List Price
9.802-200.0	358010	4mm	5/16"	.25-.63	\$1.04
8.710-456.0	358012	5mm	5/16"	.38-.88	\$1.20
8.710-457.0	358013	10mm	5/16"	.50-1.06	\$57.31
8.710-458.0	358015	H8	1/2"	.44-.91	\$1.14
8.710-459.0	358018	H10	1/2"	.56-1.06	\$1.25
8.710-460.0	358019	H12	1/2"	.69-1.25	\$1.40
8.710-461.0	358020	H16	1/2"	.75-1.50	\$1.40
8.710-464.0	358024	H32	1/2"	1.56 - 2.50	\$1.46

8.904-167.0*	358001X	1/4" ID Speedi-Clamp	\$17.13
8.904-168.0*	358004X	3/8" ID Speedi-Clamp	\$22.98
8.904-169.0*	358006X	1/2" ID Speedi-Clamp	\$23.49

*50/pk

Zinc-plated Heavy Wall Steel Pipe Fittings

- Up to 6000 PSI working pressure (18,000 PSI burst)
- Attractive zinc-plated protective coating
- U.S.-standard taper pipe threads

Adapters – Steel



Part #	Old No.	MPT x FPT	Working Pressure	List Price
8.705-356.0	142404	1/4" x 1/4"	6000	\$6.21
8.705-357.0	142405	1/4" x 3/8"	6000	\$4.55
9.804-553.0	142406	3/8" x 3/8"	6000	\$7.25
8.705-359.0	142407	3/8" x 1/2"	5000	\$5.43
8.705-360.0	142408	1/2" x 1/2"	5000	\$11.39
8.705-361.0	142409	1/2" x 3/4"	4000	\$11.39
8.705-362.0	142412	3/4" x 3/4"	4000	\$21.63

Hex Coupling – Steel



Part #	Old No.	FPT x FPT	Working Pressure	List Price
8.705-364.0	142415	1/4" x 1/4"	6000	\$2.90
8.705-366.0	142417	3/8" x 3/8"	6000	\$3.57
8.705-369.0	142420	1/2" x 1/2"	5000	\$4.86
8.705-371.0	142422	3/4" x 3/4"	5000	\$9.16

Reducing Couplings

8.705-365.0	142416	3/8" x 1/4"	6000	\$5.33
8.705-367.0	142418	1/2" x 3/8"	5000	\$7.66
8.705-368.0	142419	1/2" x 1/4"	5000	\$6.62
8.705-370.0	142421	3/4" x 1/2"	4000	\$13.61

Hex Nipple – Steel



Part #	Old No.	FPT x FPT	Working Pressure	List Price
9.802-010.0	142425	1/4" x 1/4"	6000	\$1.60
9.802-011.0	142427	3/8" x 3/8"	6000	\$2.17
9.802-012.0	142430	1/2" x 1/2"	6000	\$3.11
8.705-380.0	142434	3/4" x 3/4"	6000	\$5.95

9.802-022.0	142426	3/8" x 1/4"	6000	\$2.54
8.705-375.0	142428	1/2" x 1/4"	6000	\$4.09
8.705-376.0	142429	1/2" x 3/8"	6000	\$3.42
8.705-379.0	142431	3/4" x 1/2"	6000	\$6.16

Street Elbow – Steel



Part #	Old No.	FPT x FPT	Working Pressure	List Price
9.802-029.0	142438	1/4" x 1/4"	5000	\$4.66
9.804-080.0	142439	1/4" x 3/8"	4500	\$6.31
9.802-030.0	142440	3/8" x 3/8"	4500	\$5.36
8.705-384.0	142441	3/8" x 1/2"	3000	\$9.63
9.803-045.0	142442	1/2" x 1/2"	3000	\$8.49
8.705-386.0	142443	1/2" x 3/4"	3000	\$21.99
8.705-387.0	142444	3/4" x 3/4"	3000	\$19.41

Street Tee – Steel



Part #	Old No.	MPT x FPT x MPT	Working Pressure	List Price
8.705-428.0	142684	1/4"	5000	\$6.68
9.802-033.0	142685	3/8"	4500	\$8.59
9.802-034.0	142686	1/2"	3000	\$13.97
8.705-431.0	142687	3/4"	3000	\$24.74

Elbow – Steel



Part #	Old No.	FPT x FPT	Working Pressure	List Price
8.706-176.0		1/4" x 1/8"	4500	\$6.68
8.705-393.0	142504	1/4" x 1/4"	5000	\$4.66
8.705-394.0	142505	1/4" x 3/8"	4500	\$6.68
9.802-023.0	142506	3/8" x 3/8"	4500	\$5.59
8.705-396.0	142507	3/8" x 1/2"	3000	\$11.07
8.705-397.0	142508	1/2" x 1/2"	3000	\$9.00
8.705-398.0	142509	1/2" x 3/4"	4000	\$20.39
8.705-399.0	142512	3/4" x 3/4"	4000	\$19.92

Part #	Old No.	Description	Working Pressure	List Price
9.802-039.0	2-0053	1/2" JIC x 3/8" MPT	5000	\$4.55
9.802-040.0		1/2" JIC x 1/2" MPT	5000	\$7.30
9.802-130.0		1/2" JIC x 1/4" MPT	5000	\$8.85
8.706-906.0		1/2" JIC x 3/4" FPT	5000	\$13.82

Tee – 3 Connects



Part #	Old No.	FPT	Working Pressure	List Price
8.705-412.0	142654	1/4"	5000	\$6.88
8.705-414.0	142656	3/8"	4500	\$8.02
9.802-032.0	142658	1/2"	3000	\$11.13
8.705-417.0	142662	3/4"	3000	\$22.05

Part #	MPT	List Price
8.706-213.0	1/4"	\$11.33

Cross – 4 Connects



Part #	Old No.	FPT	Working Pressure	List Price
8.705-418.0	142664	1/4"	5000	\$12.73
8.705-419.0	142666	3/8"	4500	\$12.83
8.705-420.0	142668	1/2"	3000	\$20.91
8.705-421.0	142672	3/4"	3000	\$39.28

Reducing Bushing – Steel



Part #	Old No.	MPT x FPT	Working Pressure	List Price
9.802-046.0	142676	3/8" x 1/4"	6000	\$1.39
8.705-423.0	142678	1/2" x 1/4"	6000	\$2.23
9.802-045.0	142680	1/2" x 3/8"	6000	\$2.16
8.705-426.0	142682	3/4" x 1/2"	6000	\$3.26

Hex Pipe Plugs – Steel



Part #	Old No.	Description	Working Pressure	List Price
9.803-530.0	142701	1/4"	6000	\$0.71
8.705-433.0	142702	3/8"	6000	\$1.09
8.705-434.0	142703	1/2"	6000	\$1.60
8.705-435.0	142704	3/4"	6000	\$3.73

Pipe Nipple – Zinc



Part #	Old No.	Length x MPT	Working Pressure	List Price
8.803-043.0	142800	2" x 1/4"	6000	\$3.00
8.705-441.0	142801	3" x 1/4"	6000	\$11.95
8.705-442.0	142802	4" x 1/4"	6000	\$13.92
8.705-443.0	142803	2" x 3/8"	6000	\$8.18
8.705-985.0	142804	3" x 3/8"	6000	\$5.74
8.705-445.0	142805	4" x 3/8"	6000	\$15.01
8.705-446.0	142806	2" x 1/2"	6000	\$6.52

Part #	Old No.	Length x MPT	Working Pressure	List Price
8.802-014.0	142807	3" x 1/2"	6000	\$5.80
8.802-015.0	142808	4" x 1/2"	6000	\$7.14
8.705-996.0	142808T	5" x 1/2"	6000	\$8.23
8.705-450.0	142810	2" x 3/4"	6000	\$8.95
8.705-451.0	142811	3" x 3/4"	6000	\$14.70
8.705-452.0	142812	4" x 3/4"	6000	\$16.82
8.705-453.0	142813	6" x 3/4"	6000	\$25.31

Galvanized Pipe Fittings

- Pressed-steel fittings — external galvanized for excellent chemical resistance
- Ideal for supply line (city water pressure) applications (working pressure rating 125 PSI)

NOT recommended for high-pressure piping applications.

Pipe Street Elbows



Part #	Old No.	MPT x FPT	List Price
8.705-407.0	142604	1/4"	\$2.79
8.705-408.0	142606	3/8"	\$2.69
8.705-409.0	142608	1/2"	\$2.29
8.705-410.0	142610	3/4"	\$5.95

Pipe Tees



Part #	Old No.	FPT x FPT x FPT	List Price
8.705-456.0	142854	1/4"	\$3.16
8.705-458.0	142856	3/8"	\$3.26
8.705-459.0	142858	1/2"	\$2.17
8.705-461.0	142868	3/4"	\$3.00

Merchant Coupling



Part #	Old No.	FPT x FPT	List Price
8.705-389.0	142454	1/4"	\$2.38
8.705-390.0	142456	3/8"	\$2.54
8.705-391.0	142458	1/2"	\$2.54

Banded Coupling



Part #	Old No.	FPT x FPT	List Price
8.705-436.0	142754	1/4"	\$2.54
8.705-437.0	142756	3/8"	\$2.43
8.705-438.0	142758	1/2"	\$1.45
8.705-439.0	142760	3/4"	\$2.69

90° Elbows



Part #	Old No.	FPT x FPT	List Price
8.705-403.0	142552	1/4"	\$2.90
8.705-404.0	142556	3/8"	\$2.54
8.705-405.0	142558	1/2"	\$1.76
8.705-406.0	142560	3/4"	\$3.11

“The Big One”



Larger, heavier, and with more filtering area than competitors' filters.



- Corrosion-resistant plastic
- Stepped 1/4" and 3/8" hose barb
- Weighted to hold on to bottom of tank

Part #	Old No.	Description	List Price
8.709-938.0	340025	With Check Valve	\$3.16
8.709-939.0	340026	Without Check Valve	\$2.68

Brass Chemical Filter



50-mesh, stainless-steel screen. Removable mesh for easy cleaning. Heavy-duty, one-piece brass body holds the filter on the bottom of tank.



- 1/4" hose barb
- Stainless-steel check ball

Part #	Old No.	Description	List Price
8.803-672.0	340010X	With Check Valve	\$4.74
8.709-934.0	340012X	Without Check Valve	\$4.66

Plastic Chemical Strainer

Polypropylene and brass construction.



- 7mm hose barb

Part #	Old No.	Description	List Price
8.709-935.0	340014	w/ Check Valve	\$5.15
8.802-160.0	340015	w/o Check Valve	\$2.90

Chemical Line w/ Filter



- 6-foot long, 1/4" clear vinyl tubing

Part #	Old No.	Description	List Price
Brass Filter			
8.903-991.0	340022X	Chemical Line/ Filter w/ Check Valve	\$10.25
8.903-992.0	340023X	Chemical Line/ Filter w/o Check Valve	\$10.04
Plastic Filter			
8.903-993.0	340024X	Chemical Line/ Filter w/ Check Valve	\$9.78
8.903-996.0	340027X	Chemical Line/ Filter w/o Check Valve	\$9.52

Green-Cap In-Line Filter

The original Green-Cap!



- 6 GPM max flow
- 40-mesh stainless screen
- Diecast metal housing/ plastic cap
- 1/2" FPT inlet
- 1/2" MPT outlet
- Two 1/4" side ports
- 145 PSI max pressure

Part #	Old No.	Description	List Price
8.709-961.0	342010	Green Cap Filter	\$24.00
8.701-383.0	083441	Replacement Screen	\$8.59
8.701-382.0	083439	Replacement Cap	\$8.95
8.702-034.0	083440	Replacement O-Ring	\$0.72

All Metal In-Line Filter



- Die-cast aluminum body and cover
- Black anodized finish
- 38-mesh screen
- 170 PSI max pressure
- 195°F max temperature
- 6.6 GPM max flow
- 1/2" female x male

Part #	Old No.	Description	List Price
8.709-976.0	342030	All Metal Line Filter	\$35.95
8.704-055.0	109343	Replacement Filter	\$8.38

Heavy-Duty In-Line Filters



- 1/2" female x male
- 50-mesh screen
- 8 GPM max flow
- 145 PSI max pressure
- 140°F max temperature
- Unbreakable reinforced nylon cap

Part #	Old No.	Description	List Price
8.709-974.0	342026	Filter	\$23.79
8.709-975.0	342027	With Auxiliary (bypass) Port	\$24.01
8.704-172.0	109941	Replacement Filter	\$8.12

Clear Bowl Filters



- Low-profile style
- MPT inlet and outlet
- White nylon body
- Clear bowl
- Stainless-steel screen
- L: 3", W: 1-3/4", H: 2-3/8"

Part #	Old No.	Description	List Price
8.709-962.0	342012	1/4", 40-Mesh Screen	\$17.28
8.709-963.0	342013	1/4", 80-Mesh Screen	\$16.61
8.709-964.0	342014	3/8", 40-Mesh Screen	\$14.08
8.709-965.0	342015	3/8", 80-Mesh Screen	\$11.90
8.709-966.0	342016	1/2", 40-Mesh Screen	\$15.63
8.709-967.0	342017	1/2", 80-Mesh Screen	\$15.53
8.700-563.0	078214	80-Mesh Replacement Scrn	\$4.63
8.700-564.0	078215	40-Mesh Replacement Scrn	\$3.52

In-Line Can-Type Filters and Parts



- 40- or 80-mesh filtration
- Heavy-duty molded plastic with stainless-steel screen
- Hanger tab standard on 3/8", 1/2" and 3/4"
- Choose black or clear filter cans

Part #	Old No.	Description	List Price
40-Mesh Filters			
8.709-982.0	342105	Black, 3/8"	\$18.79
8.709-986.0	342110	Black, 1/2"	\$18.27
8.709-990.0	342115	Black, 3/4"	\$21.89
8.709-994.0	342120	Black, 1"	\$40.21
8.710-001.0	342150	Black, 1-1/4"	\$37.67
8.710-003.0	342155	Black, 1-1/2"	\$58.74
8.709-983.0	342106	Clear, 3/8"	\$43.83
8.709-987.0	342111	Clear, 1/2"	\$31.93
8.709-991.0	342116	Clear, 3/4"	\$31.11
8.709-996.0	342123	Clear, 1"	\$83.42
8.710-002.0	342151	Clear, 1-1/4"	\$64.38
8.710-004.0	342156	Clear, 1-1/2"	\$64.89

Part #	Old No.	Description	List Price
80-Mesh Filters			
8.709-988.0	342112	Black, 1/2"	\$20.54
8.709-992.0	342117	Black, 3/4"	\$20.70
8.709-995.0	342122	Black, 1"	\$39.43
8.710-005.0	342158	Black, 1-1/4"	\$53.87
8.709-999.0	342147	Black, 1-1/2"	\$59.87
8.709-989.0	342113	Clear, 1/2"	\$35.50
8.709-993.0	342118	Clear, 3/4"	\$35.33
8.709-997.0	342125	Clear, 1"	\$83.84
8.710-006.0	342159	Clear, 1-1/4"	\$64.89
8.710-000.0	342149	Clear, 1-1/2"	\$65.46

Part #	Old No.	Description	List Price
In-Line Can-Type Filter Parts – 3/8", 1/2", 3/4"			
8.700-555.0	078202	Gasket	\$1.45
8.700-557.0	078204	Viton Gasket	\$4.55
8.700-559.0	078207	Bowl – Standard Black	\$10.92
8.700-560.0	078208	Bowl – Clear	\$19.72
8.700-565.0	078216	40-Mesh Screen	\$14.20
8.700-567.0	078220	80-Mesh Screen	\$14.28
8.932-949.0	078223	3/8" Top with Tab	\$13.92
8.700-569.0	078224	1/2" Top with Tab	\$18.58
8.700-570.0	078225	3/4" Top with Tab	\$8.02

Part #	Old No.	Description	List Price
In-Line Can-Type Filter Parts – 1", 1-1/4", 1-1/2"			
8.700-556.0	078203	Gasket	\$2.23
8.700-558.0	078205	Viton Gasket	\$7.92
8.700-566.0	078217	40-Mesh Screen 1"	\$7.19
8.700-575.0	078233	40-Mesh Screen 1-1/4"	\$10.25
8.700-576.0	078234	40-Mesh Screen 1-1/2"	\$12.37
8.700-568.0	078221	80-Mesh Screen 1"	\$9.21
8.700-577.0	078237	80-Mesh Screen 1-1/4"	\$8.49
8.700-578.0	078238	80-Mesh Screen 1-1/2"	\$9.88
8.700-571.0	078226	1" Filter Top	\$44.87
8.700-572.0	078227	1-1/4" Filter Top	\$22.10
8.700-573.0	078230	Bowl Black – 1", 1-1/4", 1-1/2"	\$20.39
8.700-574.0	078231	Bowl Clear – 1", 1-1/4", 1-1/2"	\$35.24

In-Line ClearView Filter



8.710-145.0



8.710-146.0



8.710-147.0

- Stainless-steel screen
- Combination 1/2" / 3/4" hose barb
- Weighted to hold at bottom of tank or source

Part #	Old No.	Description	List Price
8.710-145.0	347091	3/8" NPT x 3/4" GH	\$25.00
8.710-147.0	347093	3/8" NPT x 3/4" GH w/ 1/4" Bypass	\$29.24
8.710-144.0	347090	1/2" NPT x 3/4" GH	\$24.94
8.710-146.0	347092	1/2" NPT x 3/4" GH w/ 1/4" Bypass	\$30.02

Y-Trap Strainer



- Brass bodies and cap
- FPT inlet and outlet
- Stainless-steel 50-mesh cylinder screen
- 170 PSI max pressure
- 194°F max temperature

Part #	Old No.	FPT	List Price
8.709-956.0	342004	1/4"	\$13.92
8.709-957.0	342006	3/8"	\$13.92
8.709-958.0	342007	1/2"	\$13.92
8.709-959.0	342008	3/4"	\$18.68
8.709-960.0	342009	1"	\$27.53

Check/Foot Valve

Includes backflow check and perforated screen, prevents damage to pump or control valves.



- Removable stainless-steel screen
- Spring-loaded check valve
- Cast-brass bodies
- FPT outlet

Part #	Old No.	Description	List Price
8.709-388.0	310882	1/2" Foot Valve/ Check and Screen	\$13.82
8.709-389.0	310883	3/4" Brass Spring Check Valve	\$24.43
8.709-390.0	310884	1" Brass Spring Check Valve	\$22.10
8.709-391.0	310886	1-1/2" Brass Spring Check Valve	\$41.71
8.709-392.0	310888	2" Brass Spring Check Valve	\$47.14

ST35/35R Suction Foot Valve



- Stainless-steel screen
- Combination 1/2" / 3/4" hose barb
- Weighted to hold at bottom of tank or source

Part #	Old No.	Description	List Price
8.709-970.0	342021	With Check Valve	\$35.19
8.709-969.0	342020	Without Check Valve	\$33.59

Tank Screen/Strainer



- Stainless-steel screen — 40- or 50-mesh
- PVC base — attaches to nipple or tubing
- Use for tank drain or chemical line

Part #	Old No.	Mesh	FPT	List Price
8.710-008.0	342304	50	1/4"	\$4.30
8.710-010.0	342306	50	3/8"	\$5.05
8.710-011.0	342307	40	1/2"	\$5.97
9.802-162.0	342308	50	1/2"	\$5.90
8.710-013.0	342311	40	3/4"	\$6.93
8.710-014.0	342312	50	3/4"	\$9.88
8.710-015.0	342316	40	1"	\$12.78
8.710-016.0	342320	40	1-1/2"	\$14.70

In-Line High-Pressure Nozzle Filters

Protect your turbo nozzle from damage caused by debris in the water flow.



8.709-978.0



8.710-149.0



8.709-979.0



8.710-150.0

- 1/4" MPT outlet
- 300°F max
- 100-mesh screen
- 5000 PSI max

Part #	Old No.	Material	Inlet	Outlet	List Price
8.709-978.0	342040	Brass	1/4" FPT	1/4" MPT	\$14.28
8.709-979.0	342042	Brass	1/4" QC	1/4" MPT	\$14.96
8.710-149.0	347097	416 SS	1/4" QC	1/4" MPT	\$21.99
8.710-150.0	347098	Brass	1/4" MPT	1/4" MPT	\$18.89
8.704-234.0	110595	Replacement filter for 342040/342042			\$4.45
8.701-201.0	080115	Replacement filter for 347097/347098			\$3.98

High-Volume Filter and Parts

Molded plastic housing.



- 3/4" FPT inlet and outlet
- 125 PSI max pressure
- 12 GPM max flow at 50 micron
- 10 GPM max flow at 5 or 20 micron
- Clear-view sump
- 14-1/2" tall x 5-1/2" port to port

Part #	Old No.	Description	List Price
8.710-017.0	342375	Housing Only	\$49.73
8.905-569.0	565375X	Mounting Bracket/Hardware	\$22.30
8.700-581.0	078280	Replacement O-Ring	\$2.69

- Pleated polyester/polypropylene core
- Recommended for large flow, low-pressure applications (up to 60 PSI)



Part #	Old No.	Description	List Price
Ultra Fine Filter Elements			
8.710-019.0	342380	5 Micron, 10 GPM	\$16.46
8.710-020.0	342382	20 Micron, 10 GPM	\$15.53
8.710-021.0	342384	50 Micron, 12 GPM	\$14.49



- Recommended for maximum filtration with reduced flow requirements (up to 130 PSI)

Part #	Old No.	Description	List Price
Synthetic String Wound Elements			
8.710-022.0	342387	5 Micron, 4 GPM	\$10.51
8.710-023.0	342389	20 Micron, 5 GPM	\$10.51
8.710-024.0	342391	50 Micron, 6 GPM	\$10.56

Fuel Filters

In-line, disposable.



8.709-942.0



9.802-211.0

Part #	Old No.	Description	List Price
9.802-211.0	341001	1/4" In/Out, Plastic	\$5.46
8.709-942.0	341002	1/4" In/Out, Metal	\$5.23
8.709-943.0	341003	3/8" In/Out, Plastic	\$4.40

Clear Bowl Fuel Filter



- Aluminum housing
- Non-replaceable 120-mesh stainless-steel screen
- 1/4" x 1/4"
- Clear acrylic bowl

Part #	Old No.	Description	List Price
8.709-948.0	341013	Complete Unit	\$16.72

Fuel Filter / Water Separator

Legacy



- 10 micron filtration
- Spin-on convenience
- Water-separation chamber
- 1/4" FPT inlet / outlet
- Easy drain water / sediment bowl

Part #	Description	List Price
8.725-306.0	Complete Unit	\$62.63
8.725-307.0*	Element Only	\$19.72

*Order 24 for a full case

Blue Top Filter

Legacy



Part #	Description	List Price
8.753-559.0	Housing, 5" 1/2" F-F	\$15.80
8.753-560.0	Housing, 5", 3/4" F-F	\$15.80
8.753-561.0	Housing, 5", 1" F-F	\$17.00
8.753-562.0	Housing, 10", 1/2" F-F	\$18.70
8.753-563.0	Housing, 10", 3/4" F-F	\$18.70
8.753-564.0	Cartridge, 10" Poly Thread (Disposable)	\$5.60
8.753-565.0	Cartridge, 5" Poly Thread (Disposable)	\$3.20
8.753-566.0	Cartridge, 10" Nylon Mesh (Washable)	\$7.30
8.753-567.0	Cartridge, 5" Nylon Mesh (Washable)	\$3.90

Fuel Filter / Water Separator

RACOR

The "Max" fuel system protector.



- 10 micron filtration
- Spin-on convenience
- Water-separation chamber
- 1/4" FPT inlet/outlet
- Easy-drain water/sediment bowl

Part #	Old No.	Description	List Price
9.802-212.0	341040	Complete Unit	\$71.82
8.709-953.0	341042	Element	\$26.42
8.700-552.0	078126	Metal Head	\$68.67
8.700-553.0	078127	Plastic Bowl	\$42.49

General Fuel Filter Element



- Can type
- 10 GPH max flow
- 10 micron filtration
- Inexpensive replacement
- Wool felt element

Part #	Old No.	Description	List Price
8.709-950.0	341017	Element	\$3.93

Racor Filter Funnel

RACOR



- 3.9 GPM
- Teflon-coated, stainless-steel filter
- Separates free water and contaminates from gasoline/diesel/kerosene

Part #	Old No.	Description	List Price
8.709-955.0	341044	Racor Filter Funnel	\$48.90

The Legacy *Revolution* Turbo Nozzle

Legacy is proud to offer the Revolution rotary nozzle. This turbo rotary nozzle is rated for up to 4350 PSI at 185°F. Turning at an astounding 4,000 RPM, the Revolution delivers faster and deeper cleaning action for the same price of 3000 PSI rotary nozzles.



With the Legacy Revolution turbo nozzle, you get:

- **Greater cleaning power:** The Revolution is engineered to increase the impact pressure by more than 10 times that of conventional nozzles!
- **Longer operating life:** The Revolution's operating life is extended significantly by its wear-resistant ceramic nozzle and bearing ring.
- **More durable and versatile:** The Revolution features an extra-resilient housing protector and is capable of handling a stream of up to 4350 PSI at 185°F.

Nozzle Part #	Old No.	Orifice	PSI	List Price
9.302-242.0	374231	3.5	4350	\$89.04
9.302-243.0	374232	4.0	4350	\$89.92
9.302-244.0	374233	4.5	4350	\$89.92
9.302-245.0	374234	5.0	4350	\$89.92
9.302-246.0	374235	5.5	4350	\$89.92
9.302-247.0	374236	6.5	4350	\$89.04
9.302-248.0	374237	7.0	4350	\$89.04
9.302-249.0	374238	12.0	4350	\$89.04

Repair Kit

2.884-972.0	079920	3.5	\$61.38
2.883-824.0	079921	4.0	\$61.38
9.302-231.0	079922	4.5	\$61.53
2.883-823.0	079923	5.0	\$61.38
2.883-822.0	079924	5.5	\$61.23
9.302-234.0	079925	6.5	\$61.53
2.884-974.0	079926	7.0	\$61.38
2.884-975.0	079927	10.0	\$61.38

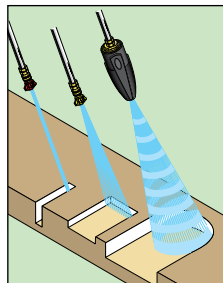

Legacy's Revolution gives you the best of both worlds: the deep cleaning impact of a 0° nozzle and the fast cleaning of a wide-coverage fan spray nozzle.

Nozzle Size Selection Chart

Determine the nozzle size by the pressure washer's GPM @ PSI (gallons per minute @ a specific pounds per square inch). If the nozzle size is too small, your equipment can be damaged. If the nozzle size is too large, cleaning ability is compromised. Nozzle fan degree does not effect nozzle size selection.

Standard Nozzle Size	Hole Size	Pounds Per Square Inch (PSI)																
		500	750	1000	1250	1500	1750	2000	2250	2500	2750	3000	3250	3500	3750	4000	4500	5000
2	.034"/0.86mm	0.71	0.87	1.00	1.12	1.22	1.32	1.41	1.50	1.58	1.66	1.73	1.80	1.87	1.94	2.00	2.12	2.24
2.5	.042"/1.07mm	0.88	1.08	1.25	1.40	1.53	1.65	1.77	1.88	1.98	2.07	2.17	2.25	2.34	2.42	2.50	2.65	2.80
3	.043"/1.09mm	1.06	1.30	1.50	1.68	1.84	1.98	2.12	2.25	2.37	2.49	2.60	2.70	2.81	2.90	3.00	3.18	3.35
3.5	.048"/1.22mm	1.24	1.52	1.75	1.96	2.14	2.32	2.47	2.63	2.77	2.90	3.03	3.15	3.27	3.39	3.50	3.71	3.91
4	.052"/1.32mm	1.41	1.73	2.00	2.24	2.45	2.65	2.83	3.00	3.16	3.32	3.46	3.61	3.74	3.87	4.00	4.24	4.47
4.5	.055"/1.40mm	1.59	1.95	2.25	2.52	2.76	2.98	3.18	3.38	3.56	3.73	3.90	4.06	4.21	4.36	4.50	4.77	5.03
5	.057"/1.45mm	1.77	2.17	2.50	2.80	3.06	3.31	3.54	3.75	3.95	4.15	4.33	4.51	4.68	4.84	5.00	5.30	5.59
5.5	.060"/1.52mm	1.94	2.38	2.75	3.07	3.37	3.64	3.89	4.13	4.35	4.56	4.76	4.96	5.14	5.33	5.50	5.83	6.15
6	.062"/1.57mm	2.12	2.60	3.00	3.35	3.67	3.97	4.24	4.50	4.74	4.97	5.20	5.41	5.61	5.81	6.00	6.36	6.71
6.5	.064"/1.63mm	2.30	2.81	3.25	3.63	3.98	4.30	4.60	4.88	5.14	5.39	5.63	5.86	6.08	6.29	6.50	6.89	7.27
7	.067"/1.70mm	2.47	3.03	3.50	3.91	4.29	4.63	4.95	5.25	5.53	5.80	6.06	6.31	6.55	6.78	7.00	7.42	7.83
7.5	.070"/1.78mm	2.65	3.25	3.75	4.19	4.59	4.96	5.30	5.63	5.93	6.22	6.50	6.76	7.02	7.26	7.50	7.95	8.39
8	.072"/1.83mm	2.83	3.46	4.00	4.47	4.90	5.29	5.66	6.00	6.32	6.63	6.93	7.21	7.48	7.75	8.00	8.49	8.94
8.5	.074"/1.88mm	3.01	3.68	4.25	4.75	5.21	5.62	6.01	6.38	6.72	7.05	7.36	7.66	7.95	8.23	8.50	9.02	9.50
9	.076"/1.93mm	3.18	3.90	4.50	5.03	5.51	5.95	6.36	6.75	7.12	7.46	7.79	8.11	8.42	8.71	9.00	9.55	10.06
9.5	.078"/1.98mm	3.36	4.11	4.75	5.31	5.82	6.28	6.72	7.13	7.51	7.88	8.23	8.56	8.89	9.20	9.50	10.08	10.62
10	.080"/2.03mm	3.54	4.33	5.00	5.59	6.12	6.61	7.07	7.50	7.91	8.29	8.66	9.01	9.35	9.68	10.00	10.61	11.18
11	.083"/2.11mm	3.89	4.76	5.50	6.15	6.74	7.28	7.78	8.25	8.70	9.12	9.53	9.92	10.29	10.65	11.00	11.67	12.30
12	.087"/2.21mm	4.24	5.20	6.00	6.71	7.35	7.94	8.49	9.00	9.49	9.95	10.39	10.82	11.22	11.62	12.00	12.73	13.42
12.5	.089"/2.26mm	4.42	5.41	6.25	6.99	7.65	8.27	8.84	9.38	9.88	10.36	10.83	11.27	11.69	12.10	12.50	13.26	13.98
13	.091"/2.31mm	4.60	5.63	6.50	7.27	7.96	8.60	9.19	9.75	10.28	10.78	11.26	11.72	12.16	12.59	13.00	13.79	14.53
15	.096"/2.44mm	5.30	6.50	7.50	8.39	9.19	9.92	10.61	11.25	11.86	12.44	12.99	13.52	14.03	14.52	15.00	15.91	16.77
20	.109"/2.77mm	7.07	8.66	10.00	11.18	12.25	13.23	14.14	15.00	15.81	16.58	17.32	18.03	18.71	19.36	20.00	21.21	22.36
25	.125"/3.18mm	8.84	10.83	12.50	13.98	15.31	16.54	17.68	18.75	19.76	20.73	21.65	22.53	23.39	24.21	25.00	26.52	27.95
30	.141"/3.58mm	10.61	12.99	15.00	16.77	18.37	19.84	21.21	22.50	23.72	24.87	25.98	27.04	28.06	29.05	30.00	31.82	33.54
40	.156"/3.96mm	14.14	17.32	20.00	22.36	24.49	26.46	28.28	30.00	31.62	33.17	34.64	36.06	37.42	38.73	40.00	42.43	44.72
50	.172"/4.37mm	17.68	21.65	25.00	27.95	30.62	33.07	35.36	37.50	39.53	41.46	43.30	45.07	46.77	48.41	50.00	53.03	55.90
60	.188"/4.78mm	21.21	25.98	30.00	33.54	36.74	39.69	42.43	45.00	47.43	49.75	51.96	54.08	56.12	58.09	60.00	63.64	67.08

Nozzle Fan Selection

Select the nozzle degree or spray angle, based on your application. Standard nozzle degrees — 0°, 15°, 25°, and 40°. Using the wrong nozzle degree can damage the surface you are cleaning.

0° – Red:

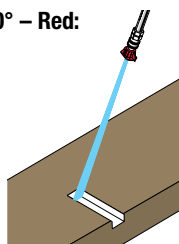

Cutting nozzle. It delivers a concentrated stream that can gouge or cut. It can cut stubborn stains from concrete and other hard surfaces.

15° – Yellow:

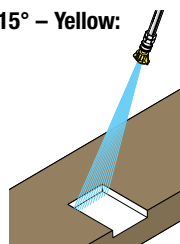

Chiseling nozzle. Working at a 45° angle, this nozzle works like a scraper, stripping paint, grease and grime from hard surfaces.

25° – Green:

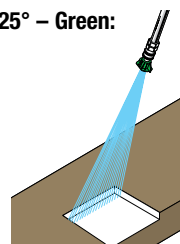

Flushing nozzle. The most commonly used nozzle for cleaning dirt from siding, sidewalks and metal furniture as well as for wet sweeping leaves.

40° – White:

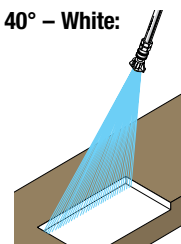

Wash nozzle. Its wide spray allows you to wash and rinse a large area fast. It is usually safe with most surfaces, including aluminum siding, windows and vehicles.

Legacy 4/pk and 5/pk Color-Coded QC Nozzle Kits



1/4" Quick Coupler Nozzle Kits

- Hardened stainless-steel one-piece body for long life
- High-impact, uniform, flat-spray pattern
- Color-coded by spray angle
- Includes 40 x 65 soap nozzle



Made in USA

4/pk (0°, 25°, 40°, and Soap)

Part #	Nozzle Size	List Price	10+
8.726-117.0	3.0	\$16.46	\$15.57
9.104-028.0	3.25	\$16.46	\$15.57
8.726-119.0	3.5	\$16.46	\$15.57
8.726-120.0	4.0	\$16.46	\$15.57
8.726-121.0	4.5	\$16.46	\$15.57
8.726-122.0	5.0	\$16.46	\$15.57
8.726-123.0	5.5	\$16.46	\$15.57
8.726-124.0	6.0	\$16.46	\$15.57
8.726-125.0	6.5	\$16.46	\$15.57

5/pk (0°, 15°, 25°, 40°, and Soap)

Part #	Nozzle Size	List Price	10+
9.104-024.0	3.0	\$20.03	\$19.28
9.104-016.0	3.25	\$19.98	\$19.28
8.726-128.0	3.5	\$20.03	\$19.28
9.104-030.0	4.0	\$20.03	\$19.28
8.726-130.0	4.5	\$20.03	\$19.28
8.726-131.0	5.0	\$19.98	\$19.28
8.726-132.0	5.5	\$20.03	\$19.28
8.726-133.0	6.0	\$20.03	\$19.28
8.726-134.0	6.5	\$20.03	\$19.28



Legacy Individual 1/4" QC Nozzles



Made in USA

"QC", Color-coded, hardened stainless nozzle, fits most 1/4" quick couplers. Rated for 4000 PSI.



QC Nozzles

List Price	10+
\$4.40	\$

Orifice	0° (Red) Part No	15° (Yellow) Part No	25° (Green) Part No	40° (White) Part No
3.0	8.723-576.0	8.902-482.0	8.902-484.0	8.902-485.0
3.25	8.708-538.0	8.708-539.0	8.708-540.0	8.708-541.0
3.5	8.723-577.0	8.726-104.0	8.708-526.0	8.902-487.0
3.75	8.708-527.0	8.708-528.0	8.708-529.0	8.708-530.0
4.0	8.708-531.0	8.708-532.0	8.708-533.0	8.708-534.0
4.5	8.723-578.0	8.708-535.0	8.708-536.0	8.708-537.0
5.0	8.726-105.0	8.726-106.0	8.726-107.0	8.726-108.0
5.5	8.723-579.0	8.902-492.0	8.708-542.0	8.902-493.0
6.0	8.726-109.0	8.726-110.0	8.726-111.0	8.726-112.0
6.5	8.726-113.0	8.726-114.0	8.726-115.0	8.726-116.0



QC Soap Nozzle

Part #	Orifice	Degree	List Price	10+
8.723-636.0	40	65°	\$4.40	\$4.12



4/pk and 5/pk Color-Coded QC Nozzle Sets

Nozzle sets contain a complete set of four quick coupler nozzles at 0°, 15°, 25°, and 40°. The 5/pk includes one 40 x 65° soap nozzle.



4/pk

Part #	Old No.	Nozzle Size	List Price
8.708-712.0	259700	3.5	\$26.34
8.708-713.0	259701	4.0	\$26.21
8.708-714.0	259702	4.5	\$26.21
8.708-715.0	259703	5.0	\$26.34
8.708-716.0	259704	5.5	\$26.34
8.708-717.0	259705	6.0	\$26.34
8.708-718.0	259706	6.5	\$26.34

5/pk

Part #	Old No.	Nozzle Size	List Price
9.104-014.0	259710	3.5	\$31.67
8.708-721.0	259711	4.0	\$31.67
9.104-015.0	259712	4.5	\$31.67
8.708-723.0	259713	5.0	\$31.67
8.708-724.0	259714	5.5	\$31.67
8.708-725.0	259715	6.0	\$31.67
8.708-726.0	259716	6.5	\$31.67

General Pump Nozzles

These quick-coupled, color-coded, hardened stainless nozzles fit most 1/4" quick couplers. Rated for 4000 PSI.



Q-Style Nozzle

List Price
\$5.43

Orifice	0° Part No	0° Old No	15° Part No	15° Old No	25° Part No	25° Old No	40° Part No	40° Old No
3.0	9.802-287.0	259610	9.802-288.0	259611	9.802-289.0	259612	9.802-289.0	259613
3.5	9.802-291.0	259615	9.802-292.0	259616	9.802-293.0	259617	9.802-294.0	259618
4.0	9.802-295.0	259620	9.802-296.0	259621	9.802-297.0	259622	9.802-298.0	259623
4.5	9.803-810.0	259625	9.803-811.0	259626	9.803-812.0	259627	9.803-813.0	259628
5.0	9.802-299.0	259630	9.802-300.0	259631	9.802-301.0	259632	9.802-302.0	259633
5.5	9.802-303.0	259635	9.802-304.0	259636	9.802-305.0	259637	9.802-306.0	259638
6.0	9.802-307.0	259640	9.802-308.0	259641	9.802-309.0	259642	9.802-310.0	259643
6.5	8.708-681.0	259645	8.708-682.0	259646	8.708-683.0	259647	8.708-684.0	259648
7.0	9.803-800.0	259650	9.803-801.0	259651	9.803-802.0	259652	9.803-803.0	259653
7.5	8.708-689.0	259655	8.708-690.0	259656	8.708-691.0	259657	8.708-692.0	259658
8.0	8.708-693.0	259660	8.708-694.0	259661	8.708-695.0	259662	8.708-696.0	259663
8.5	8.708-697.0	259665	8.708-698.0	259666	8.708-699.0	259667	8.708-700.0	259668
9.0	8.708-701.0	259670	8.708-702.0	259671	8.708-703.0	259672	8.708-704.0	259673
10.0	8.708-705.0	259675	8.708-706.0	259676	8.708-707.0	259677	8.708-708.0	259678



**M-Style
1/4" Male Threads**

1/4" male pipe thread nozzles, rated up to 5000 PSI. Hardened stainless-steel nozzle insert ensures consistent, accurate orifice size.

List Price
\$6.52

Orifice	0° Part No	0° Old No	15° Part No	15° Old No	25° Part No	25° Old No	40° Part No	40° Old No
3.0	8.708-572.0	259100	8.708-573.0	259101	8.708-574.0	259102	8.708-575.0	259103
3.5	8.708-576.0	259104	8.708-577.0	259105	8.708-578.0	259106	8.708-579.0	259107
4.0	8.708-580.0	259108	8.708-581.0	259109	8.708-582.0	259110	8.708-583.0	259111
4.5	8.708-584.0	259112	8.708-585.0	259113	8.708-586.0	259114	8.708-587.0	259115
5.0	8.708-588.0	259116	8.708-589.0	259117	8.708-590.0	259118	8.708-591.0	259119
5.5	8.708-592.0	259120	8.708-593.0	259121	8.708-594.0	259122	8.708-595.0	259123
6.0	8.708-596.0	259125	8.708-597.0	259126	8.708-598.0	259127	8.708-599.0	259128
6.5	8.708-600.0	259130	8.708-601.0	259131	8.708-602.0	259132	8.708-603.0	259133
7.0	8.708-604.0	259135	8.708-605.0	259136	8.708-606.0	259137	8.708-607.0	259138
7.5	8.708-608.0	259140	8.708-609.0	259141	8.708-610.0	259142	8.708-611.0	259143
8.0	8.708-612.0	259145	8.708-613.0	259146	8.708-614.0	259147	8.708-615.0	259148
8.5	8.708-616.0	259150	8.708-617.0	259151	8.708-618.0	259152	8.708-619.0	259153
9.0	8.708-620.0	259155	8.708-621.0	259156	8.708-622.0	259157	8.708-623.0	259158
10.0	8.708-624.0	259160	8.708-625.0	259161	8.708-626.0	259162	8.708-627.0	259163



Q-Style Chemical Nozzles, are brass with a large #40 orifice and 65° spray angle. Ideal for low-pressure chemical applications.

Q-Style Chemical Nozzle

Part #	Old No.	Orifice	Degree	List Price
9.802-311.0	259690	40	65°	\$4.40
8.708-711.0	259695	50	15°	\$4.50



Nozzle Holder Grommet

Part #	Old No.	Description	List Price
8.710-343.0	349917	Grommets – 7/16" x 15/16" x 3/8"	\$0.28

Spraying Systems Nozzles



1/4" Male Threads

1/4" male pipe thread meg nozzles, rated up to 4000 PSI. Hardened stainless-steel nozzle ensures consistent, accurate orifice size.

- Orifice recessed for protection
- 4000 PSI rated working pressure
- ± 2% flow tolerance @ 70°F
- Hard-edge pattern, light center requires overlap to cover center

List Price

\$7.04

Orifice	0° Part No	0° Old No	15° Part No	15° Old No	25° Part No	25° Old No	40° Part No	40° Old No
2.0	8.707-637.0	251100	8.707-640.0	251105	8.707-643.0	251110	8.707-648.0	251115
2.5	8.707-646.0	251113	8.707-650.0	251116	8.707-653.0	251119	-	-
3.0	8.707-655.0	251120	8.707-657.0	251125	8.707-659.0	251130	8.707-661.0	251135
3.5	8.707-662.0	251140	8.707-664.0	251145	8.707-666.0	251150	8.707-667.0	251155
4.0	8.707-669.0	251160	8.707-671.0	251161	8.707-673.0	251165	8.707-675.0	251170
4.5	8.707-678.0	251175	8.707-679.0	251180	8.707-680.0	251185	8.707-681.0	251190
5.0	8.707-683.0	251195	8.707-686.0	251200	8.707-688.0	251205	8.707-691.0	251210
5.5	8.707-694.0	251215	8.707-695.0	251220	8.707-697.0	251225	8.707-698.0	251230
6.0	8.707-700.0	251235	8.707-702.0	251240	8.707-703.0	251245	8.707-705.0	251250
6.5	8.707-708.0	251255	8.707-710.0	251260	8.707-711.0	251265	8.707-712.0	251270
7.0	8.707-713.0	251275	8.707-715.0	251280	8.707-716.0	251285	8.707-717.0	251290
7.5	8.707-718.0	251300	8.707-719.0	251305	8.707-721.0	251310	8.707-722.0	251315
8.0	8.707-723.0	251320	8.707-726.0	251325	8.707-727.0	251330	8.707-729.0	251335
8.5	8.707-734.0	251340	8.707-735.0	251345	8.707-736.0	251350	8.707-738.0	251355
9.0	8.707-739.0	251360	8.707-741.0	251365	8.707-743.0	251370	8.707-746.0	251375
10.0	8.707-747.0	251380	8.707-751.0	251385	8.707-754.0	251390	8.707-756.0	251395
11.0	8.707-760.0	251400	8.707-761.0	251405	8.707-762.0	251410	8.707-763.0	251415
12.0	8.707-764.0	251420	8.707-766.0	251425	8.707-767.0	251430	8.707-768.0	251435
12.5	8.707-769.0	251440	8.707-770.0	251445	8.707-771.0	251450	8.707-772.0	251455
13.0	8.707-773.0	251460	8.707-774.0	251465	8.707-776.0	251470	8.707-778.0	251475
15.0	8.707-782.0	251480	8.707-787.0	251485	8.707-789.0	251490	8.707-790.0	251495
20.0	8.707-795.0	251500	8.707-800.0	251505	8.707-802.0	251510	8.707-804.0	251515
25.0	8.707-807.0	251520	8.707-811.0	251525	8.707-812.0	251530	8.707-813.0	251535
30.0	8.707-814.0	251540	8.707-817.0	251545	8.707-818.0	251550	8.707-819.0	251555
40.0	8.707-821.0	251560	8.707-824.0	251565	8.707-826.0	251570	8.707-827.0	251575
50.0	8.707-828.0	251580	8.707-830.0	251585	8.707-832.0	251590	8.707-833.0	251595
60.0	8.707-834.0	251600	8.707-835.0	251605	8.707-837.0	251610	8.707-838.0	251615



1/8" Male Threads

1/8" male pipe thread meg nozzles, rated up to 4000 PSI. Hardened stainless-steel nozzle ensures consistent, accurate orifice size.

- Orifice recessed for protection
- 4000 PSI rated working pressure
- ± 2% flow tolerance @ 70°F
- Hard-edge pattern, light center requires overlap to cover center

List Price

\$7.14

Orifice	0° Part No	0° Old No	15° Part No	15° Old No	25° Part No	25° Old No	40° Part No	40° Old No
2.0	8.707-529.0	250100	8.707-536.0	250105	8.707-537.0	250110	8.707-538.0	250115
3.0	8.707-540.0	250120	8.707-542.0	250125	8.707-543.0	250130	8.707-544.0	250135
3.5	-	-	8.707-545.0	250137	8.707-546.0	250138	-	-
4.0	8.707-547.0	250140	8.707-549.0	250145	8.707-550.0	250150	8.707-551.0	250155
4.5	8.707-552.0	250160	8.707-554.0	250165	8.707-556.0	250170	8.707-557.0	250175
5.0	8.707-558.0	250180	8.707-559.0	250185	8.707-561.0	250190	8.707-564.0	250195
5.5	8.707-567.0	250200	8.707-568.0	250205	8.707-569.0	250210	8.707-570.0	250215
6.0	8.707-571.0	250220	8.707-572.0	250225	8.707-573.0	250230	8.707-575.0	250235
6.5	8.707-577.0	250240	8.707-578.0	250245	8.707-579.0	250250	8.707-581.0	250255
7.0	8.707-582.0	250260	8.707-584.0	250265	8.707-585.0	250270	8.707-586.0	250275
7.5	8.707-588.0	250280	8.707-589.0	250285	8.707-591.0	250290	8.707-592.0 [†]	250295
8.0	8.707-593.0	250300	8.707-594.0	250305	8.707-595.0	250310	8.707-596.0	250315
8.5	8.707-598.0	250320	8.707-599.0	250325	8.707-600.0	250330	8.707-601.0	250335
9.0	8.707-602.0	250340	8.707-604.0	250345	8.707-605.0	250350	8.707-607.0	250355
9.5	-	-	8.707-609.0	250365	8.707-610.0	250370	8.707-611.0	250375
10.0	8.707-612.0	250380	8.707-613.0	250385	8.707-614.0	250390	8.707-616.0	250395
11.0	8.707-618.0	250400	8.707-619.0	250405	8.707-620.0	250410	-	-
12.0	8.707-621.0	250420	-	-	-	-	8.707-623.0	250435
15.0	8.707-625.0	250440	8.707-626.0	250445	8.707-627.0	250450	-	-
20.0	8.707-628.0	250500	-	-	-	-	-	-

Spraying Systems Nozzles



QC "Wash Jet" Nozzle
Color-coded Nozzle Protector

List Price

\$8.54

"QC" or Quick Connect Hardened Stainless Meg Nozzle, fits most 1/4" quick couplers.
Rated for 4000 PSI.

- 4000 PSI
- Flow-rated tolerance of $\pm 2\%$
- Hardened stainless-steel
- 300°F
- Fits Hansen and Parker quick-couplers

Orifice	0° Red Part No	0° Red Old No	15° Yellow Part No	15° Yellow Old No	25° Green Part No	25° Green Old No	40° White Part No	40° White Old No
3.0	8.708-417.0	255120	8.708-418.0	4-12803015S	8.708-419.0	255140	8.708-420.0	4-12803040S
3.5	8.708-422.0	4-12803500S	8.708-423.0	4-12803515S	8.708-424.0	4-12803525S	8.708-425.0	4-12803540S
4.0	8.708-427.0	255160	8.708-428.0	255161	8.708-429.0	255165	8.708-430.0	255170
4.5	8.708-431.0	255175	8.708-432.0	255180	8.708-433.0	255185	8.708-434.0	255190
5.0	8.708-435.0	255195	8.708-436.0	255200	8.708-437.0	255205	8.708-438.0	255210
5.5	8.708-439.0	255215	8.708-440.0	255220	8.708-441.0	255225	8.708-442.0	255230
6.0	8.708-443.0	255235	8.708-444.0	255240	8.708-445.0	255245	8.708-446.0	255250
6.5	8.708-447.0	255255	8.708-448.0	255260	8.708-449.0	255265	8.708-450.0	255270
7.0	8.708-451.0	255275	8.708-452.0	255280	8.708-453.0	255285	8.708-454.0	255290
7.5	8.708-455.0	255300	8.708-456.0	255305	8.708-457.0	255310	8.708-458.0	255315
8.0	8.708-459.0	255320	8.708-460.0	255325	8.708-461.0	255330	8.708-462.0	255335
9.0	-	-	8.708-463.0	255365	8.708-464.0	255370	8.708-465.0	255375
10.0	8.708-467.0	255380	8.708-468.0	255385	8.708-469.0	255390	8.708-470.0	255395
12.0	8.708-471.0	255420	8.708-472.0	255425	8.708-473.0	255430	8.708-474.0	255435

Brass Nozzles for Low-Pressure Applications



List Price

\$4.24

1/4" male pipe thread Vee Jet nozzles, brass inexpensive alternative for applications up to 500 PSI.

- Feather edge for wide coverage
- Allows overlap for even application
- Excellent for low-pressure chemical and acid applications
- 1/4" MPT connects

1/4" Male Threads

Nozzle Size	0° Part #	0° Old No	15° Part #	15° Old No	25° Part #	25° Old No	40° Part #	40° Old No	50° Part #	50° Old No	65° Part #	65° Old No
15	8.708-203.0	254260B	8.708-204.0	254261B	8.708-206.0	254262B	8.708-208.0	254264B	8.708-210.0	254265B	8.708-212.0	254266B
20	8.708-218.0	254270B	8.708-222.0	254271B	8.708-225.0	254272B	8.708-228.0	254274B	8.708-230.0	254275B	8.708-232.0	254276B
30	8.708-242.0	254290B	8.708-244.0	254291B	8.708-246.0	254292B	8.708-249.0	254294B	8.708-251.0	254295B	8.708-253.0	254296B
40	8.708-258.0	254300B	8.708-260.0	254301B	8.708-262.0	254302B	8.708-264.0	254304B	8.708-266.0	254305B	8.708-268.0	254306B
50	8.708-275.0	254310B	8.708-277.0	254311B	8.708-279.0	254312B	8.708-280.0	254314B	8.708-282.0	254315B	8.708-284.0	254316B
60	8.708-289.0	254320B	8.708-290.0	254321B	8.708-292.0	254322B	8.708-294.0	254324B	8.708-296.0	254325B	8.708-297.0	254326B
70	8.708-302.0	254330B	8.708-304.0	254331B	8.708-306.0	254332B	8.708-308.0	254334B	8.708-309.0	254335B	8.708-310.0	254336B

Broad Spray Stainless-Steel Nozzles



List Price

\$8.23

1/4" male pipe thread 303 stainless-steel Vee Jet nozzles, low- to medium-volume up to 500 PSI medium-pressure/special application PSI.

1/4" Male Threads

Nozzle Size	Equiv. Orifice Dia	50° Part No	50° Old No	65° Part #	65° Old No	80° Part #	80° Old No	95° Part #	95° Old No	110° Part #	110° Old No
1.0	.026	8.708-074.0	254105	8.708-075.0	254106	8.708-076.0	254107	8.708-078.0	254108	8.708-079.0	254109
1.5	.031	8.708-085.0	254115	8.708-086.0	254116	8.708-087.0	254117	8.708-089.0	254118	8.708-090.0	254119
2.0	.036	8.708-095.0	254125	8.708-096.0	254126	8.708-097.0	254127	8.708-099.0	254128	8.708-101.0	254129
3.0	.043	8.708-108.0	254135	8.708-109.0	254136	8.708-110.0	254137	8.708-112.0	254138	8.708-114.0	254139
4.0	.047	8.708-121.0	254145	8.708-122.0	254146	8.708-123.0	254147	8.708-125.0	254148	8.708-127.0	254149
5.0	.053	8.708-133.0	254155	8.708-134.0	254156	8.708-136.0	254157	8.708-138.0	254158	8.708-140.0	254159
6.0	.058	8.708-148.0	254175	8.708-149.0	254176	8.708-151.0	254177	8.708-155.0	254178	8.708-157.0	254179
7.0	.063	8.708-162.0	254195	8.708-163.0	254196	8.708-164.0	254197	-	-	8.708-165.0	254199
8.0	.067	8.708-172.0	254215	8.708-173.0	254216	8.708-175.0	254217	8.708-177.0	254218	8.708-179.0	254219

Tip-Jet Nozzle System – Tips and Components

“Tip-Jet” Nozzle Systems are versatile nozzling systems for everyday or specialized applications. Also on page 19.

Flat spray, full cone, hollow cone and solid stream patterns, metering orifices and atomizing tips are all available in the Tip-Jet system. Capacities range from .55 to 20 GPM.



Tip-Jet Tips

- Neat and simple tip change
- Hardened stainless-steel tips with vanes
- Strainers available
- Body components available in brass, zinc-plated steel or stainless-steel
- Rated to 4000 PSI

List Price
\$14.96

Orifice Size	0° Part #	0° Old No.	15° Part #	15° Old No.	25° Part #	25° Old No.	40° Part #	40° Old No.
3.0	8.708-016.0	253316	8.708-017.0	253317N	8.708-018.0	253318	–	–
4.0	8.708-019.0	253330	8.708-020.0	253331	8.708-021.0	253332	8.708-022.0	253333
4.5	8.708-023.0	253338	8.708-024.0	253339	8.708-025.0	253340	8.708-026.0	253341
5.0	8.708-027.0	253346	8.708-028.0	253348	8.708-029.0	253349	8.708-030.0	253350
5.5	8.708-031.0	253355	8.708-032.0	253357	8.708-033.0	253358	8.708-034.0	253359
6.0	8.708-035.0	253365	8.708-036.0	253367	8.708-037.0	253368	8.708-038.0	253369
6.5	8.708-039.0	253375	–	–	8.708-040.0	253377	8.708-041.0	253378
7.0	8.708-042.0	253383	8.708-043.0	253385	8.708-044.0	253386	8.708-045.0	253387
7.5	8.708-046.0	253392	8.708-047.0	253393	8.708-048.0	253394	8.708-049.0	253395
8.0	8.708-050.0	253400	8.708-051.0	253401	8.708-052.0	253402	8.708-053.0	253403
9.0	8.708-054.0	253415	8.708-055.0	253416	8.708-056.0	253417	8.708-057.0	253418
10.0	8.708-058.0	253456	8.708-059.0	253457	8.708-060.0	253458	8.708-061.0	253459



Tip-Jet Nozzle Bodies, MPT inlet connections in 1/4", 3/8" and 1/2" sizes. All outlet connections are 11/16" — 16 male thread to fit Tip-Jet tip retainers and adapters.



Tip-Jet Nozzle Bodies

Part #	Old No.	Material, MPT-1/4"	List Price
8.707-886.0	252511	Nylon	\$0.73
8.707-898.0	252640B	Brass	\$2.74
8.707-899.0	252642	Stainless-steel	\$18.47
8.707-916.0	252861P	Polypropylene	\$0.62



Tip-Jet Adapter Caps

Tip-Jet Adapter Caps, similar to tip retainers, but have FPT connections for in-line applications.

Part #	Old No.	Material, MPT	List Price
8.707-919.0	252878B	Brass, 1/8"	\$3.88
8.707-921.0	252880B	Brass, 1/4"	\$3.57
8.707-922.0	252881	Stainless-Steel, 1/4"	\$15.11



Tip-Jet Retainer Caps

Tip-Jet Retainer Caps, fits all Tip-Jet nozzle bodies, holds spray tips and metering orifices firmly in place.

Part #	Old No.	Material, MPT	List Price
8.707-915.0	252858B	Brass, Hex	\$1.60
8.707-918.0	252875	Plated Steel, Hex	\$3.26
8.707-888.0	252565	Stainless-Steel, Hex	\$9.37



Tip Retainer 18 mm thread, fits vent grip lance. See tip jet nozzles in nozzle section.

Part #	Old No.	Description	List Price
8.710-901.0	373065	Tip Retainer	\$6.47



Tip-Jet Strainers

Tip-Jet Strainers fit into nozzle body cavity to stop nozzle clogging. Brass with stainless-steel mesh.

Part #	Old No.	Material, MPT	List Price
8.707-894.0	252627	50-Mesh	\$3.31
8.707-895.0	252629	100-Mesh	\$3.31
8.707-896.0	252631	200-Mesh	\$4.61

Soft-Edge and Hard-Edge Nozzle Protector

Ideal for protecting sensitive surfaces against damage. Hard plastic body is stable enough to tightly hold nozzle adapter for heavy-duty use.



- 1/4" FPT inlet/outlet
- 300°F

Part #	Description	List Price
8.723-668.0	ST-10 Zinc-plated Nozzle Adapter	\$10.92
8.723-669.0	ST-10 Stainless-steel Adapter	\$11.39

Soap Nozzles



“Black” Soap Nozzles, are brass with a large #40 orifice. Ideal for low-pressure chemical applications.

Part #	Old No.	Size	Nozzle Degree	List Price
8.708-478.0	255905B	40	25°	\$8.18
8.708-479.0	255920B	40	65°	\$8.18

Rosebud Nozzle Guard



Molded rubber guard fits tightly around the nozzle to protect the nozzle and painted surfaces.

- 1/8" meg

Part #	Old No.	Description	List Price
8.710-870.0	373012	Nozzle Guard	\$3.05

Dirt Killer Rotating Nozzle

4700 maximum PSI, a popular model providing great impact and cleaning power.



- 180°F maximum temperature
- 1/4" inlet

8.712-429.0

Part #	Old No.	Orifice	PSI	List Price
8.712-429.0	4-20091	045	3200	\$195.18
8.701-160.0	4-200910	Repair Kit		\$130.20
8.740-148.0	4-20092	055	4700	\$333.39
8.701-161.0	4-200920	Repair Kit		\$183.20

Rotojet Soft – Hard Rotating Nozzle

Offers the cleaning efficiency of a high-pressure rotating nozzle with the feature of changing from a hard spray for concrete to a soft spray for wood by simply pushing or pulling the finger protected nozzle.



- 3600 PSI

8.711-054.0

Part #	Old No.	Orifice	List Price
8.711-052.0	374245	030	\$96.46
8.711-053.0	374246	035	\$85.54
8.711-054.0	374247	040	\$85.54
8.711-055.0	374248	045	\$169.74

MV Triple-Function Nozzle

Provides three cleaning options: low-pressure for soap or chemical application; a 15° angle for high-pressure cleaning; and a rotating nozzle for maximum cleaning efficiency.



- 3000 PSI

8.711-068.0

Part #	Old No.	Orifice	List Price
8.711-067.0	374291	035	\$143.87
8.711-068.0	374292	040	\$143.87

Lance Nozzle Couplers

Changes MPT lance to FPT for mounting MPT nozzles.



Part #	Old No.	Description	List Price
Brass			
8.705-150.0	140452	1/8" x 1/8"	\$1.14
8.705-155.0	140502	1/4" x 1/8"	\$1.71
8.705-151.0	140454	1/4" x 1/4"	\$1.55
Steel			
8.710-713.0	368903	1/8" X 1/8"	\$3.93
8.710-712.0	368902	1/4" x 1/8"	\$4.55
8.710-714.0	368904	1/4" x 1/4"	\$4.55

Rotomax Rotating Nozzle 3500 and 5800 PSI



- Up to 5800 PSI max pressure
- 1/4" FPT inlet
- 176°F max temperature
- Weight 9 oz
- Replaceable stainless-steel orifices

Part #	Old No.	Description	PSI	Std Nozzle Equiv	List Price
8.711-035.0	374205	Rotomax I	3500	4.5	\$114.33
8.711-036.0	374210	Rotomax II	3500	5.5	\$119.48
8.711-037.0	374215	Rotomax III	3500	6.5	\$114.33
8.711-038.0	374216	Rotomax 401	5800	4.5	\$245.30
8.711-039.0	374217	Rotomax 403	5800	6.5	\$245.30
8.701-532.0	084400X	Repair Kit			\$42.02

Viper Rotating Nozzle



- 5000 PSI max pressure
- 190°F max temperature
- 1/4" FPT inlet
- Weight 1.0 oz

Part #	Old No.	Description	PSI	Std Nozzle Equiv	List Price
8.711-000.0	374126	Viper	5000	4.5	\$141.80
8.711-001.0	374127	Viper	5000	5.5	\$141.46
8.701-163.0	080004	Repair Kit	5000	4.5	\$81.14
8.701-166.0	080006	Repair Kit	5000	5.5	\$82.28

MV Hi-Lo Turbo Nozzle



Combines the power of a 0° stream and a 20° wide-angle spray pattern to improve cleaning. Hi-Lo pressure feature eliminates changing to a low-pressure nozzle for soap and chemical application.



- 2500 PSI

8.711-070.0

Part #	Old No.	Orifice	List Price
8.711-069.0	374294	030	\$39.59
8.711-070.0	374295	035	\$39.95

Rotojet 2000

Economy turbo nozzle.



- Great for economy washers
- 2000 PSI max pressure
- 1/4" FPT inlet
- 140°F max temperature
- 5.4 oz weight

Part #	Old No.	Size	Color	List Price
8.711-026.0	374175	3.0	Yellow	\$44.76
8.711-027.0	374176	3.5	Black	\$44.76
8.711-028.0	374177	4.0	Blue	\$44.76



Turbo Nozzles

AP Revolution Turbo Nozzle is rated for up to 5100 PSI at 212°F. High-impact nozzle at unbelievable pricing!

- Forged brass
- Precision ceramic
- Durable rubber cover



3000 PSI



4000 PSI



5100 PSI

Nozzle Part #	Orifice	List Price	3+	5+
3000 PSI				
8.726-056.0	3.5	\$50.72	\$47.12	\$44.64
8.726-057.0	4.0	\$50.72	\$47.12	\$44.64
8.726-058.0	4.5	\$50.72	\$47.12	\$44.64
8.726-059.0	5.0	\$50.72	\$47.12	\$44.64
8.726-060.0	5.5	\$50.72	\$47.12	\$44.64
8.726-061.0	6.0	\$50.47	\$47.12	\$44.64
4000 PSI				
8.726-068.0	3.5	\$56.87	\$52.79	\$50.11
8.726-069.0	4.0	\$56.60	\$52.79	\$50.11
8.726-070.0	4.5	\$56.60	\$52.79	\$50.11
8.726-071.0	5.0	\$56.87	\$52.79	\$50.11
8.726-072.0	5.5	\$56.60	\$52.79	\$50.11
8.726-073.0	6.0	\$56.87	\$52.79	\$50.11
5100 PSI				
8.726-080.0	3.5	\$104.54	\$96.19	\$91.14
8.726-081.0	4.0	\$104.54	\$96.19	\$91.14
8.726-082.0	4.5	\$104.54	\$96.19	\$91.14
8.726-083.0	5.0	\$104.54	\$96.19	\$91.14
8.726-084.0	5.5	\$104.54	\$96.19	\$91.14
8.726-085.0	6.0	\$104.54	\$96.19	\$91.14

Repair Kit Part #	Orifice	List Price
3000 PSI		
8.726-062.0	3.5	\$25.62
8.726-063.0	4.0	\$25.62
8.726-064.0	4.5	\$25.62
8.726-065.0	5.0	\$25.62
8.726-066.0	5.5	\$25.62
8.726-067.0	6.0	\$25.49
4000 PSI		
8.726-074.0	3.5	\$33.43
8.726-075.0	4.0	\$33.43
8.726-076.0	4.5	\$33.43
8.726-077.0	5.0	\$33.43
8.726-078.0	5.5	\$33.43
8.726-079.0	6.0	\$33.43
5100 PSI		
8.726-086.0	3.5	\$55.68
8.726-087.0	4.0	\$55.68
8.726-088.0	4.5	\$55.68
8.726-089.0	5.0	\$55.68
8.726-090.0	5.5	\$55.68
8.726-091.0	6.0	\$55.68

Rotojet 3700 / Rotojet 5800

0° Impact, 25° pattern, no gears — no teeth — no bearings. Exclusive design of the Rotojet 3700 / Rotojet 5800 eliminates start up impact and damage to internal nozzle.

- High-strength, forged brass
- Precision ceramic orifice and matching race
- Durable rubber/plastic cover
- 1/4" FNPT



3700 PSI	List Price
	\$73.43

3700 PSI			
Part #	Old No	Size	PSI
8.711-002.0	374130	3.0	3700
8.711-003.0	374131	3.5	3700
8.711-005.0	374134	4.0	3700

3700 PSI			
Part #	Old No	Size	PSI
8.711-004.0	374132	4.5	3700
8.711-006.0	374135	5.0	3700

3700 PSI			
Part #	Old No	Size	PSI
8.711-008.0	374137	5.5	3700
8.711-007.0	374136	6.0	3700

Rotojet 3700 PSI

- 190°F

Repair Kit	List Price
	\$77.47

Repair Kit			
Part #	Old No	Size	PSI
8.704-039.0	109297	3.0	3700
8.704-038.0	109296	3.5	3700
8.704-040.0	109298	4.0	3700

Repair Kit			
Part #	Old No	Size	PSI
8.704-041.0	109299	4.5	3700
8.704-042.0	109300	5.0	3700

Repair Kit			
Part #	Old No	Size	PSI
8.704-043.0	109301	5.5	3700
8.704-044.0	109302	6.0	3700

Must start with nozzle down.



5800 PSI	List Price
	\$156.29

5800 PSI			
Part #	Old No	Size	PSI
8.711-009.0	374142	3.0	5800
8.711-010.0	374143	3.5	5800
8.711-011.0	374144	4.0	5800
8.711-012.0	374145	4.5	5800
8.711-013.0	374146	5.0	5800

5800 PSI			
Part #	Old No	Size	PSI
8.711-014.0	374148	5.5	5800
8.711-015.0	374150	6.0	5800
8.711-016.0	374151	6.5	5800
8.711-017.0	374153	7.0	5800
8.711-018.0	374156	8.0	5800

5800 PSI			
Part #	Old No	Size	PSI
8.711-019.0	374158	9.0	5800
8.711-020.0	374160	10.0	5800
8.711-023.0	374162	11.0	5800
8.711-021.0	374161	12.0	5800

Rotojet 5800 PSI

- 200°F

Repair Kit	List Price
	\$70.64

Repair Kit			
Part #	Old No	Size	PSI
8.704-065.0	109428	3.0	5800
8.704-066.0	109429	3.5	5800
8.704-067.0	109430	4.0	5800
8.704-068.0	109431	4.5	5800
8.704-069.0	109432	5.0	5800

Repair Kit			
Part #	Old No	Size	PSI
8.704-070.0	109433	5.5	5800
8.704-071.0	109434	6.0	5800
8.704-072.0	109435	6.5	5800
8.704-073.0	109436	7.0	5800
8.704-074.0	109437	8.0	5800

Repair Kit			
Part #	Old No	Size	PSI
8.704-075.0	109438	9.0	5800
8.704-076.0	109439	10.0	5800
8.704-077.0	109440	11.0	5800
8.704-078.0	109441	12.0	5800

Turbo Nozzle

Provides great impact and cleaning power.



8.711-098.0



8.711-088.0

3650 PSI	List Price
	\$89.22

5100 PSI	List Price
	\$110.75

Part #	Old No.	Orifice	PSI
8.711-105.0	374369	3.0	3650
8.711-097.0	374361	3.5	3650
8.711-098.0	374362	4.0	3650
8.711-099.0	374363	4.5	3650
8.711-100.0	374364	5.0	3650

Part #	Old No.	Orifice	PSI
8.711-101.0	374365	5.5	3650
8.711-102.0	374366	6.0	3650
8.711-096.0	374360	6.5	3650
8.711-103.0	374367	7.0	3650
8.711-104.0	374368	8.0	3650

Part #	Old No.	Orifice	PSI
8.711-086.0	374350	3.0	5100
8.711-087.0	374351	3.5	5100
8.711-088.0	374352	4.0	5100
8.711-089.0	374353	4.5	5100
8.711-090.0	374354	5.0	5100

Part #	Old No.	Orifice	PSI
8.711-091.0	374355	5.5	5100
8.711-092.0	374356	6.0	5100
8.711-093.0	374357	6.5	5100
8.711-094.0	374358	7.0	5100
8.711-095.0	374359	8.0	5100

Turbo Nozzle Repair Kits (for 3650 and 5100 PSI)

Part #	Description	List Price
8.749-912.0	Repair Kit YR51K30	\$65.10
8.749-913.0	Repair Kit YR51K35	\$63.86
8.749-914.0	Repair Kit YR51K40	\$65.10
8.749-915.0	Repair Kit YR51K45	\$65.10
8.749-916.0	Repair Kit YR51K50	\$65.10
8.749-917.0	Repair Kit YR51K55	\$65.10
8.749-918.0	Repair Kit YR51K60	\$65.10
8.749-919.0	Repair Kit YR51K65	\$65.10
8.749-920.0	Repair Kit YR51K70	\$65.10
8.749-921.0	Repair Kit YR51K80	\$65.10

Suttner Turbo Nozzles



ST-357 –
3600 PSI

3600 PSI	List Price
	\$93.94

Repair Kit	List Price
	\$55.68

- Forged brass
- Precision ceramic orifice

- Rubber cover/protector
- 190°F

Part #	Old No	Size	PSI
8.710-986.0	374103	3.0	3600
8.710-987.0	374104	3.5	3600
8.710-989.0	374106	4.0	3600

ST-357 Repair Kit			
Part #	Old No	Size	PSI
8.701-570.0	085458	3.0	3600
8.701-569.0	085457	3.5	3600
8.701-564.0	085452	4.0	3600

Part #	Old No	Size	PSI
8.710-988.0	374105	4.5	3600
8.710-991.0	374107	5.0	3600

ST-357 Repair Kit			
Part #	Old No	Size	PSI
8.701-562.0	085449	4.5	3600
8.701-565.0	085453	5.0	3600

Part #	Old No	Size	PSI
8.710-993.0	374109	5.5	3600
8.710-992.0	374108	6.0	3600

ST-357 Repair Kit			
Part #	Old No	Size	PSI
8.701-568.0	085456	5.5	3600
8.701-566.0	085454	6.0	3600



ST-457 –
5800 PSI

5800 PSI	List Price
	\$161.46

Repair Kit	List Price
	\$81.09

Part #	Old No	Size	PSI
8.711-072.0	374300	3.0	6000
8.711-073.0	374301	3.5	6000
8.711-074.0	374302	4.0	6000
8.711-075.0	374303	4.5	6000

ST-457 Repair Kit			
Part #	Old No	Size	PSI
8.701-572.0	085465A	3.0	6000
8.701-571.0	085465	3.5	6000
8.701-573.0	085466	4.0	6000
8.701-574.0	085467	4.5	6000

Part #	Old No	Size	PSI
8.711-076.0	374304	5.0	6000
8.711-077.0	374305	5.5	6000
8.711-078.0	374306	6.0	6000
8.711-079.0	374308	7.0	6000

ST-457 Repair Kit			
Part #	Old No	Size	PSI
8.701-575.0	085468	5.0	6000
8.701-576.0	085469	5.5	6000
8.701-577.0	085470	6.0	6000
8.701-578.0	085472	7.0	6000

Part #	Old No	Size	PSI
8.711-080.0	374309	8.0	6000
8.711-081.0	374310	10.0	6000

ST-457 Repair Kit			
Part #	Old No	Size	PSI
8.701-579.0	085473	8.0	6000
8.701-580.0	085474	10.0	6000



Duo-Reg Nozzle

Duo-Reg Nozzles are designed for industrial use and priced for ALL applications. Easy push/pull, low-to-high pressure change, and easy-turn to adjust from 0° to 80° fan pattern.



- Stainless-steel replaceable orifices
- 3000 PSI capability
- 300°F
- 1/4" FPT connect
- Tough glass-filled nylon cover
- Compact size: 3-3/8" long, 1-3/16" diameter, 5.7 oz weight

List Price
\$26.44

Part No	Old No	Color	Orifice	Part #	Old No.	Color	Orifice
8.710-959.0	374030	Yellow	3.0	8.710-963.0	374050	Green	5.0
8.710-960.0	374035	White	3.5	8.710-964.0	374055	Sky	5.5
8.710-961.0	374040	Blue	4.0	8.710-965.0	374060	Black	6.0
8.710-962.0	374045	Brown	4.5	8.710-966.0	374065	Drk Green	6.5

Multi-Fan Nozzle

Adjust from maximum **Impact Zero Stream** to 80° wide-angle spray with a twist of the nozzle body.



- 1/4" FPT connect
- 2900 PSI
- Replaceable stainless-steel orifices
- Stainless-steel deflector
- 210°F

List Price
\$21.89

Part No	Old No	Color	Orifice	Part No	Old No	Color	Orifice	Part No	Old No	Color	Orifice
8.710-932.0	373352	Yellow	3.0	8.710-936.0	373357	Green	5.0	8.710-940.0	373361	-	7.0
8.710-933.0	373353	White	3.5	8.710-937.0	373358	Sky	5.5	8.710-941.0	373362	-	7.5
8.710-934.0	373354	Blue	4.0	8.710-938.0	373359	Black	6.0	8.710-942.0	373363	-	8.0
8.710-935.0	373356	Brown	4.5	8.710-939.0	373360	-	6.5				

Interchangeable Orifice – Fits Nozzles Above

Replacement Orifices for duo-reg and multi-fan nozzles.



List Price
\$9.16

Part #	Old No	Orifice	Part #	Old No	Orifice	Part #	Old No	Orifice
8.701-448.0	084021	3.0	8.701-453.0	084028	5.0	8.701-458.0	084033	7.0
8.701-449.0	084023	3.5	8.701-454.0	084029	5.5	8.701-459.0	084034	7.5
8.701-450.0	084025	4.0	8.701-455.0	084030	6.0	8.701-460.0	084035	8.0
8.701-452.0	084027	4.5	8.701-456.0	084031	6.5			

HL250 High/Low Variable Angle Nozzle

Push/Pull for easy change between high- and low-pressure; simple twist to adjust 0°-80° spray fan pattern.



- Stainless-steel replaceable orifice
- Durable glass-filled nylon cover
- 200°
- 4000 PSI
- 1/4" FPT inlet
- Weight: .4 lbs

List Price
\$25.62

Part No	Old No	Color	Orifice	Part No	Old No	Color	Orifice	Part No	Old No	Color	Orifice
8.710-972.0	374086	Lt Green	2.0	8.710-976.0	374091	Dk Yellow	4.0	8.710-980.0	374095	Dk Green	6.0
8.710-973.0	374087	Pink	2.5	8.710-977.0	374092	Blue	4.5	8.710-981.0	374096	Lt Blue	6.5
8.710-974.0	374088	White	3.0	8.710-978.0	374093	Purple	5.0	8.710-982.0	374097	Orange	7.0
8.710-975.0	374090	Brown	3.5	8.710-979.0	374094	Dark Red	5.5	8.710-983.0	374098	Silver	8.0

High-Pressure Nozzle Filters

Turbo nozzle protector.



8.709-978.0



8.710-149.0



8.709-979.0



8.710-150.0

- 1/4" MPT outlet
- 300°F max temperature
- 100-mesh screen
- 5000 PSI max pressure

Part #	Old No.	Material	Inlet	Outlet	List Price
8.709-978.0	342040	Brass	1/4" FPT	1/4" MPT	\$14.28
8.709-979.0	342042	Brass	1/4" QC	1/4" MPT	\$14.96
8.710-149.0	347097	416 SS	1/4" QC	1/4" MPT	\$21.99
8.710-150.0	347098	Brass	1/4" MPT	1/4" MPT	\$18.89
8.704-234.0	110595	Replacement filter for 342040/342042			\$4.45
8.701-201.0	080115	Replacement filter for 347097/347098			\$3.98

Double Nozzle Head



- Durable machined-brass body
- Stainless-steel ball
- Chemical-resistant
- Heavy nickel-plate
- 3600 PSI max pressure
- 300°F max temperature
- Up to 10 GPM flow for low side pressure at 250 PSI
- 1/4" female inlet, two female outlets
- New ball guide and seat

Part #	Old No.	Description	List Price
8.710-897.0	373058A	Double Nozzle Head	\$29.41

Rollover Nozzle – Twist-Type

Holds two meg nozzles on opposite sides for positive change from chemical application to high-pressure rinse.



- Nickel-plated brass body
- 180°F max temperature
- 1000 PSI max pressure

Part #	Old No.	Description	List Price
8.710-893.0	373054	Dual 1/4" FPT in/out	\$42.49
8.900-022.0	075020X	Repair Kit	\$11.39

Adjustable Nozzle

Compact, full-feature unit weighs only 4.3 oz, same functions as ST-51N.



- 3600 PSI max pressure
- 10 GPM max flow
- 300°F max temperature
- Machined-brass body
- Nylon adjustment knob
- 1/4" FPT inlet/outlet

Part #	Old No.	Description	List Price
8.710-891.0	373051P	Adjustable Nozzle	\$18.16

ST-56 Rollover Nozzle Head



- Brass body
- 3600 PSI max pressure
- 8 GPM max flow
- 300°F max temperature
- Glass-filled polyimide cover
- 1/4" FPT inlet and outlet

Part #	Old No.	Description	List Price
8.710-895.0	373056	Rollover Nozzle Head	\$35.09

ST-51N Adjustable Nozzle



Nozzle holder allows water to be diverted around the fixed orifice nozzle, dropping the pressure and allowing the chemical injector to operate.



- Attaches to 1/4" MPT lance
- Accepts 1/4" meg nozzles
- 8.0 GPM max flow
- 300°F max temperature
- 3600 PSI max pressure
- 5.9 oz weight

Part #	Old No.	Description	List Price
8.710-889.0	373051	ST-51N	\$29.86

Steam Nozzle



Steam Nozzle Blank



Flat Steam Nozzle

- One-piece brass
- 1450 PSI
- Steam nozzle – 1/4" F
- Steam blank – 3/8" M

Part #	Old No.	Description	List Price
8.710-958.0	373710	Flat Steam Nozzle, 1.5mm	\$24.48
8.710-957.0	373702	Steam Nozzle Blank – Drill to Size	\$11.64
8.904-374.0	373705	Nozzle Blank, Drilled to 1.6mm	\$12.58
8.712-415.0		Steam Nozzle, Drilled to 5/64"	\$51.70

Variable Angle Nozzle



- One-piece brass
- 1450 PSI
- Steam nozzle – 1/4" F
- Steam blank – 3/8" M

Part #	Description	List Price
8.710-971.0	Variable Angle Nozzle	\$25.18



Stainless-Steel Sewer Nozzles



- 4100 PSI max pressure
- Corrosion-resistant stainless-steel
- One forward orifice
- Three rear orifices

Part #	Old No.	FPT	Size	List Price
8.710-905.0	373075	1/8"	5.0	\$17.28
8.710-906.0	373076	1/8"	5.5	\$17.28
8.710-907.0	373077	1/8"	6.0	\$17.44
8.710-908.0	373078	1/4"	6.5	\$18.79
8.710-909.0	373079	1/4"	7.0	\$18.79
8.710-910.0	373080	1/4"	9.5	\$18.94

Sewer/Tube Cleaning Nozzles

The reverse jets on the fixed and rotary nozzles pull the hose through the tube or sewer line and blast debris from line or tube walls.



- Backward ports drive the nozzle forward and flush debris
- Forward ports blast into pipe and breaks up clogs and debris
- Physically small for cornering ability
- 4200 PSI
- Corrosion-resistant stainless-steel construction
- Orifice size indicated on non-rotating styles
- Rotating style adds extra agitation and surface cleaning

Part #	Old No.	Nozzle Size	Orifice Size	O.D.	Ports	List Price
Non-Rotating Sewer Nozzles						
8.710-875.0	373024	1/8"	4.5	.580"	0-forward, 3 back	\$24.32
8.710-874.0	373023	1/8"	5.5	.580"	1-forward, 3 back	\$24.58
8.710-878.0	373027	1/4"	4.5	.730"	1-forward, 3 back	\$23.07
8.710-876.0	373025	1/4"	5.5	.730"	1-forward, 3 back	\$23.18
8.710-877.0	373026	1/4"	6.0	.730"	1-forward, 4 back	\$24.12
8.710-880.0	373029	1/4"	7.5	.730"	1-forward, 4 back	\$24.58
8.710-879.0	373028	1/4"	8.0	.730"	1-forward, 3 back	\$23.65
8.710-881.0	373032	1/4"	12.0	.730"	1-forward, 3 back	\$23.39
8.710-885.0	373038	3/8"	4.0	.920"	1-forward, 3 back	\$51.29
8.710-884.0	373037	3/8"	5.5	.920"	1-forward, 3 back	\$49.06
8.710-886.0	373039	3/8"	8.5	.920"	1-forward, 4 back	\$51.54
8.710-883.0	373036	3/8"	12.0	.920"	1-forward, 4 back	\$50.04
8.710-882.0	373035	3/8"	14.0	.920"	1-forward, 4 back	\$50.04



0-forward, 3 back ports



1-forward, 3 back ports

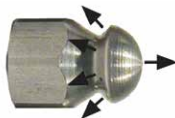

1-forward, 4 back ports



- Rotating sewer nozzle
- Adds extra agitation
- 4000 PSI
- **Back Jet Only**

Part #	Old No.	Rotating Nozzle	Size	Ports	List Price
Rotating Sewer Nozzles					
8.710-899.0	373062	1/8"	5.5	0-forward, 3 back	\$51.39
8.710-898.0	373061	1/4"	5.5	0-forward, 3 back	\$51.65
8.710-900.0	373064	1/4"	8.0	0-forward, 3 back	\$52.16
8.710-887.0	373040	1/4" Duct Clnr*	5.5	0-forward, 2 side	\$50.70

*Duct cleaner jet to sides instead of reverse

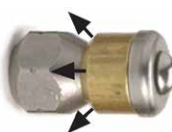

0 forward, 3 back ports



0 forward, 2 side ports

Nozzle Protector/Coupler



- Protect nozzles and finished surfaces
- Deep nozzle recess
- Tough plastic protector
- 1/4" FPT coupler inlet

Part #	Old No.	Nozzle	List Price
8.710-866.0	373002	1/8"	\$3.93
8.710-867.0	373004	1/4"	\$3.57

Slip-on Nozzle Protector

A durable, easy-to-use nozzle protector. Plastic rubber compound — flexible and tough!



- 1-1/2" diameter at flare-end
- Slip-fits standard lances
- 2-1/2" long
- Only 1.2 oz!
- Slip-on to Lance
- Attach nozzle coupler and nozzle
- Slide protector forward for complete nozzle protection

Part #	Old No.	Description	List Price
8.710-868.0	373006	Slip-on Nozzle Protector	\$3.93

Legacy Compact Foamer



Generates a high-density clinging foam for extended dwell time to increase chemical action.



- Stainless-steel, aluminum and brass
- 5" long, 1" diameter
- 4 and 6.5 nozzle included
- 1-5 GPM max flow
- 195°F max temperature
- 2500 PSI max pressure

Part #	Old No.	Description	List Price
8.903-998.0	344022V	1/8" F Inlet	\$60.96
8.903-999.0	344023V	1/4" F Inlet	\$56.20

NOTE: Most cleaning chemicals perform best when applied at 120°-150°F and can be applied as a foam by adding a foaming agent. See your chemical supplier to obtain the correct product.

Foam Cannon

The ideal foam generator application accessory meters the foaming chemical for customized foam type and applies the foam to match the application.



- Stainless-steel 1.5mm orifice (#5.5 nozzle equivalent)
- Brass meter valve
- 3200 PSI max pressure
- High-impact glass-filled body
- 4.8 GPM max flow
- Stainless-steel foam turbulator
- 140°F max temperature
- 1/4" FPT lance connect

Part #	Old No.	Description	List Price
8.710-125.0	344030	Foam Cannon/ Injector	\$99.60
8.710-126.0	344032	Foam Cannon/ Injector/Bottle	\$118.45
8.704-222.0	110311	Replacement Turbulator Screen	\$17.18

Legacy HD Pumps — the most durable pump on the market. **Legacy^{HD}**

Legacy is introducing the next wave in high-pressure pumps, the Legacy HD Pump. This heavy-duty, high-pressure pump is the outcome of years of research and development, resulting in a number of upgrades over previous pump models. Premium, long-life components and new design features make the Legacy HD pump a standout among other high-pressure pumps. Tests prove it will hold up better in rugged working conditions.

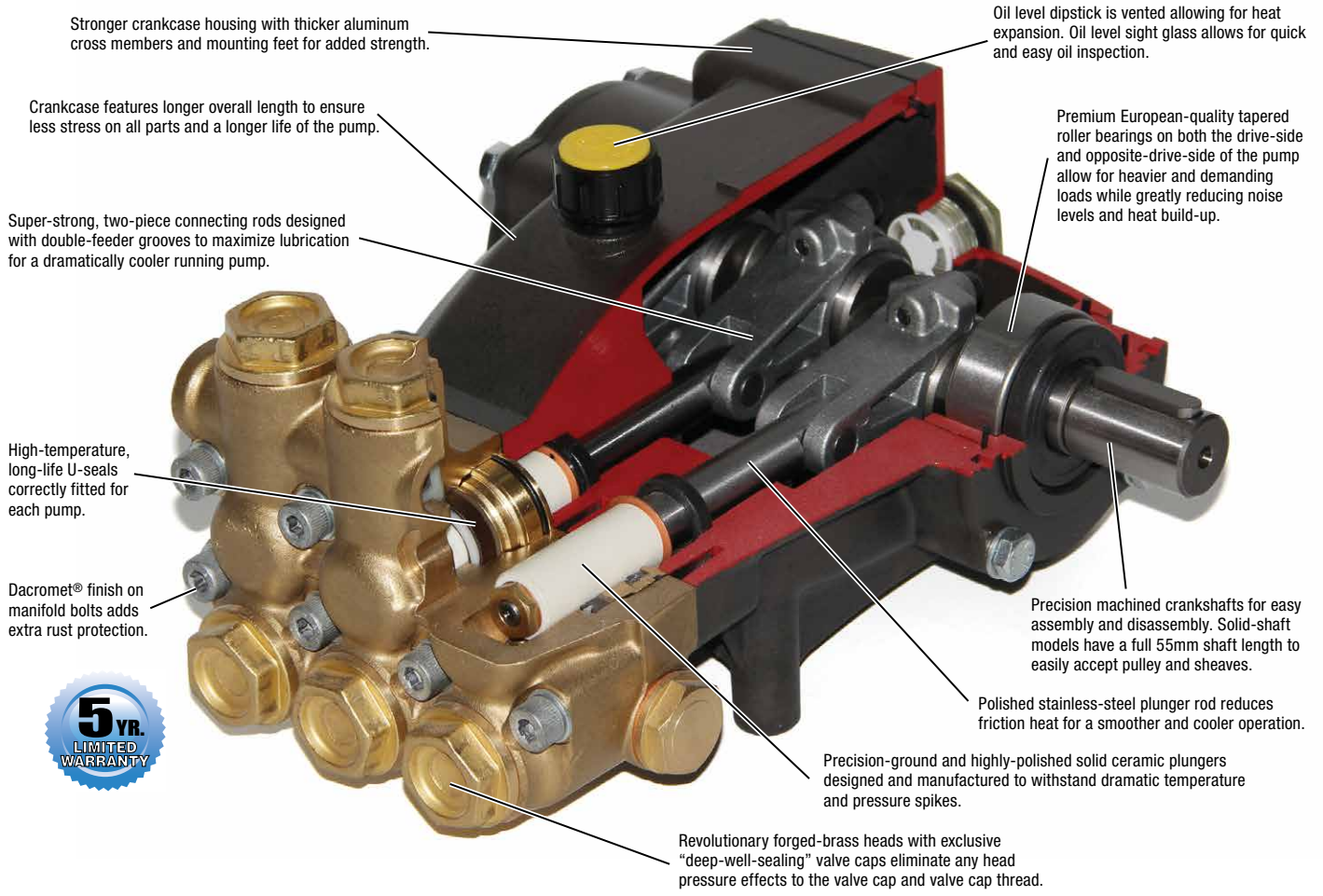

Take the Legacy HD Pump Durability Challenge!

We believe the Legacy HD Pump is the strongest, most durable pump in the market. We've tested the pump in extreme conditions and are confident in its strength and performance. We ran the pump dry in separate tests for 24 hours, and the pump showed no sign of wear.

We challenge you to try the new Legacy HD Pump. Run the pump dry. Take it apart and look how well it holds up. The Legacy HD holds up in these extreme conditions. Imagine how it will perform with everyday regular use!

Belt Drive Pumps



GX SERIES:

- 1/2" inlet x 3/8" outlet



Part #	Model No.	GPM	PSI	HP	RPM	Shaft	Weight	List Price
8.921-661.0	GX5450R	5.0	5000	17.0	1650	25mm	39 lbs	\$1,397.78
8.921-662.0	GX5450L	5.0	5000	17.0	1650	25mm	39 lbs	\$1,485.23
8.904-962.0	GX8030R.1	8.0	3000	16.5	1460	25mm	39 lbs	\$1,582.52
8.904-963.0	GX8030L.1-Left	8.0	3000	16.5	1460	25mm	39 lbs	\$1,582.52
8.920-597.0	GX9536.2R	9.5	3625	23.6	1740	25mm	38 lbs	\$1,482.16
8.920-598.0	GX9536.2L	9.5	3625	23.6	1740	25mm	38 lbs	\$1,482.16
8.920-599.0	GX1036.2R	10.4	3625	25.8	1740	25mm	38 lbs	\$1,482.16
8.920-600.0	GX1036.2L	10.4	3625	25.8	1740	25mm	38 lbs	\$1,482.16
8.904-966.0	GX1025R.1	10.6	2500	16.5	1725	25mm	39 lbs	\$1,582.52
8.904-965.0	GX1025L.1-Left	10.6	2500	16.5	1725	25mm	39 lbs	\$1,582.52
8.920-602.0	GX1622.2R	15.8	2200	23.8	1740	25mm	38 lbs	\$1,500.75
8.920-603.0	GX1622.2L	15.8	2200	23.8	1740	25mm	38 lbs	\$1,500.75

Legacy HD Pumps (continued) – Belt Drive Units



GM Series

GM SERIES:

- 1/2" inlet x 3/8" outlet

Legacy HD

Part #	Model #	GPM	PSI	HP	RPM	Shaft	Weight	List Price
8.751-197.0	GM3540R.3	3.5	4000	9.5	1850	24mm	22 lbs	\$704.84
8.751-198.0	GM4030R.3	4	3000	8.2	1000	24mm	22 lbs	\$769.01
8.904-942.0	GM4030L.2-Left	4	3000	8.2	1000	24mm	22 lbs	\$695.52
8.751-200.0	GM4035R.3	4.8	3500	7.5	1500	24mm	22 lbs	\$790.74
8.751-201.0	GM4035L.3-Left	4.8	3500	7.5	1500	24mm	22 lbs	\$769.01
8.751-202.0	GM5030R.3	5.1	3000	13.5	1550	24mm	22 lbs	\$790.74
8.751-203.0	GM5030L.3	5.1	3000	13.5	1550	24mm	22 lbs	\$825.18
8.751-244.0	GM6035R.3	5.6	3500	13.5	1750	24mm	22 lbs	\$912.87
8.751-245.0	GM6035L.3	5.6	3500	13.5	1750	24mm	22 lbs	\$790.74



GT Series

GT SERIES:

- 1/2" inlet x 3/8" outlet

Legacy HD

Part #	Model #	GPM	PSI	HP	RPM	Shaft	Weight	List Price
8.750-728.0	GT5635.1	5.6	3500	13.5	1450	24mm	33 lbs	\$931.12
8.750-729.0	GT5635.1-Left	5.6	3500	13.5	1450	24mm	33 lbs	\$927.36
8.921-722.0	GT4540.2R	4.5	4000	12.3	1360	25mm	39 lbs	\$946.71
8.921-723.0	GT4540.2L	4.5	4000	12.3	1360	25mm	39 lbs	\$946.71
8.921-724.0	GT6036.2R	6.0	3600	14.8	1450	25mm	39 lbs	\$958.41
8.921-725.0	GT6036.2L	6.0	3600	14.8	1450	25mm	39 lbs	\$958.41
8.921-726.0	GT5636.2R	5.6	3600	13.8	1450	24mm	39 lbs	\$932.54
8.921-727.0	GT5636.2L	5.6	3600	13.8	1450	24mm	39 lbs	\$932.54



GD Series

GD SERIES:

- 1/2" inlet x 3/8" outlet

Legacy HD

Part #	Model #	GPM	PSI	HP	RPM	Shaft	Weight	List Price
8.916-556.0	GD3025R	3.0	2500	5.0	1180	24mm	16 lbs	\$576.80
8.904-940.0	GD3030R	3.0	3000	9.0	1650	24mm	16 lbs	\$576.80
8.916-557.0	GD4020R.1	4.0	2000	5.0	1550	24mm	16 lbs	\$576.80



GB Series

GB SERIES:

- 1/2" inlet x 3/8" outlet

Legacy HD

Part #	Model #	GPM	PSI	HP	RPM	Shaft	Weight	List Price
8.923-809.0	GB3030R	3.0	3000	6.2	1650	24mm	14.5 lbs	\$810.07
8.923-810.0	GB3030L	3.0	3000	6.2	1650	24mm	14.5 lbs	\$810.07
8.923-811.0	GB4025R	4.0	2500	6.8	1550	24mm	14.5 lbs	\$810.07
8.923-812.0	GB4025L	4.0	2500	6.8	1550	24mm	14.5 lbs	\$810.07

Legacy HD Pumps – Direct Drive Units



GS Series

GS SERIES:

- 1/2" inlet x 3/8" outlet
- Direct couple-to-gas engine

Legacy HD

Part #	Model #	GPM	PSI	HP	RPM	Shaft	Weight	List Price
8.751-205.0	GS3040G.3	3.0	4000	9.0	3400	1" Hollow	24.5 lbs	\$702.77
8.751-206.0	GS3540G.3	3.5	4000	11.0	3400	1" Hollow	23 lbs	\$702.77
8.751-207.0	GS4040G.3	4.0	4000	13.0	3400	1" Hollow	23 lbs	\$702.77
8.751-208.0	GS5030G.3	5.0	3000	16.0	3400	1" Hollow	24.5 lbs	\$734.85

Legacy HD Pumps (continued) – Direct Drive Units



GG Series

GG SERIES:

- 1/2" inlet x 3/8" outlet
- Direct couple-to-gas engine

Legacy HD

Part #	Model #	GPM	PSI	HP	RPM	Shaft	Weight	List Price
8.904-967.0	GG2530G.1	2.5	3000	11.0	3400	3/4" Hollow	16.5 lbs	\$636.09
8.904-968.0	GG3030G.1	3.0	3000	13.0	3400	3/4" Hollow	16.5 lbs	\$636.09
8.904-969.0	GG3035G1.1	3.0	3500	10.5	3400	1" Hollow	18 lbs	\$636.09
8.916-558.0	GG3535G1.1	3.5	3500	12.0	3400	1" Hollow	18 lbs	\$636.09
8.916-559.0	GG4030G1.1	4.0	3000	12.0	3400	1" Hollow	18 lbs	\$636.09



GP Series

GP SERIES:

- 1/2" inlet x 3/8" outlet
- Direct couple-to-gas engine

Legacy HD

Part #	Model #	GPM	PSI	HP	RPM	Shaft	Weight	List Price
8.923-813.0	GP2535G	2.5	3500	6.0	3400	3/4" Hollow	16.75 lbs	\$618.07
8.923-814.0	GP3035G	3.0	3500	7.2	3400	3/4" Hollow	16.75 lbs	\$618.07
8.923-815.0	GP3035G1	3.0	3500	7.2	3400	1" Hollow	18 lbs	\$609.07
8.923-816.0	GP3535G1	3.5	3500	8.4	340	1" Hollow	18 lbs	\$609.07
8.923-817.0	GP4035G1	4.0	3500	9.6	3400	1" Hollow	18 lbs	\$609.07



GE Series

GE SERIES:

- 1/2" inlet x 3/8" outlet
- NEMA 56C Frame
- Direct couple-to-electric motor

Legacy HD

Part #	Model #	GPM	PSI	HP	RPM	Shaft	Weight	List Price
8.904-933.0	GE2020F.1	2.0	2000	3.0	3450	5/8" Hollow	17 lbs	\$597.20
8.904-934.0	GE2020S.1	2.0	2000	3.0	1725	5/8" Hollow	17 lbs	\$597.20
8.904-936.0	GE2825F.1	2.8	2500	5.0	3450	5/8" Hollow	17 lbs	\$597.20
8.916-560.0	GE2825S.1	2.8	2500	5.0	1725	5/8" Hollow	17 lbs	\$597.20
8.904-938.0	GE3525F.1	3.5	2500	5.0	3450	3/4" Hollow	17 lbs	\$597.20



GF Series

GF SERIES:

- 1/2-14 BSPP-F inlet x 3/8-19 BSPP-F outlet
- NEMA 56C Frame
- Direct couple-to-electric motor

Legacy HD

Part #	Model #	GPM	PSI	HP	RPM	Shaft	Weight	List Price
8.923-818.0	GF2030F	2.1	3000	4.3	3450	5/8" Hollow	17 lbs	\$880.07
8.923-819.0	GF2030S	2.1	3000	4.3	1725	5/8" Hollow	17 lbs	\$880.07
8.923-820.0	GF2830F	2.8	3000	5.8	3450	5/8" Hollow	17 lbs	\$880.07
8.923-821.0	GF2830S	2.8	3000	5.8	1725	5/8" Hollow	17 lbs	\$880.07
8.923-822.0	GF3530F	3.5	3000	7.2	3450	5/8" Hollow	17 lbs	\$880.07



FOG Series

FOG SERIES:

- 3/8-19 BSPP-F inlet x 3/8-19 BSPP-F outlet
- NEMA 56C Frame
- Direct couple-to-electric motor

Legacy HD

Part #	Model #	GPM	PSI	HP	RPM	Shaft	Weight	List Price
8.754-500.0	FOG0614R	0.6	1450	0.6	1740	5/8" Hollow	12 lbs	\$396.38
8.754-501.0	FOG1214R	1.2	1450	1.2	1740	5/8" Hollow	12 lbs	\$396.32
8.754-502.0	FOG1914R	1.9	1450	1.9	1740	5/8" Hollow	12 lbs	\$401.54
8.754-503.0	FOG2514R	2.5	1450	2.5	1740	5/8" Hollow	12 lbs	\$396.38



HY Series

HY SERIES:

- 1/2" inlet x 3/8" outlet
- Direct couple-to-electric motor

Legacy HD

Part #	Model #	GPM	PSI	HP	RPM	Shaft	Weight	List Price
8.754-984.0	HY1515	4	3000	5.5	1450	5/8" Hollow	16.75 lbs	\$611.08
8.754-985.0	HY1520	4	3000	8.2	1450	5/8" Hollow	16.75 lbs	\$624.68

Legacy HD Pump Repair Kit Selection Chart

Use the selection chart below to find the correct repair kits for the specific Legacy HD Pump Model.

Pump Model	Seal Kit (qty per pump)	List Price	Complete Seal Kit (qty per pump)	List Price	Ceramic Plunger Kit (qty per pump)	List Price	Valve Kit (qty per pump)	List Price	Plunger Oil Seal Kit (qty per pump)	List Price
FOG0614R	NA		8.754-575.0 (3)	\$24.80	8.754-576.0 (3)	\$24.46	8.754-577.0 (1)	\$14.39	8.754-578.0 (1)	\$5.29
FOG1214R	NA		8.754-575.0 (3)	\$24.80	8.754-576.0 (3)	\$24.46	8.754-577.0 (1)	\$14.39	8.754-578.0 (1)	\$5.29
FOG1914R	NA		8.754-575.0 (3)	\$24.80	8.754-576.0 (3)	\$24.46	8.754-577.0 (1)	\$14.39	8.754-578.0 (1)	\$5.29
FOG2514R	NA		8.754-575.0 (3)	\$24.80	8.754-576.0 (3)	\$24.46	8.754-577.0 (1)	\$14.39	8.754-578.0 (1)	\$5.29
GB3030L	8.754-856.0 (1)	CALL	8.754-857.0 (3)	CALL	8.754-858.0 (3)	CALL	8.754-859.0 (1)	CALL	9.803-937.0 (1)	\$7.66
GB3030R	8.754-856.0 (1)	CALL	8.754-857.0 (3)	CALL	8.754-858.0 (3)	CALL	8.754-859.0 (1)	CALL	9.803-937.0 (1)	\$7.66
GB4025L	8.754-856.0 (1)	CALL	8.754-857.0 (3)	CALL	8.754-858.0 (3)	CALL	8.754-859.0 (1)	CALL	9.803-937.0 (1)	\$7.66
GB4025R	8.754-856.0 (1)	CALL	8.754-857.0 (3)	CALL	8.754-858.0 (3)	CALL	8.754-859.0 (1)	CALL	9.803-937.0 (1)	\$7.66
GD3025	8.725-356.0 (1)	\$106.09	8.725-357.0 (3)	\$50.62	9.803-935.0 (3)	\$45.54	9.803-936.0 (1)	\$59.02	9.803-937.0 (1)	\$7.66
GD3030	8.725-354.0 (1)	\$75.45	8.725-355.0 (3)	\$41.72	9.803-934.0 (3)	\$39.96	9.803-936.0 (1)	\$59.02	9.803-937.0 (1)	\$7.66
GD4020.1	8.725-356.0 (1)	\$106.09	8.725-357.0 (3)	\$50.62	9.803-935.0 (3)	\$45.54	9.803-936.0 (1)	\$59.02	9.803-937.0 (1)	\$7.66
GE2020F.1	8.725-354.0 (1)	\$75.45	8.725-355.0 (3)	\$41.72	9.803-934.0 (3)	\$39.96	9.803-936.0 (1)	\$59.02	9.803-937.0 (1)	\$7.66
GE2020S.1	8.725-356.0 (1)	\$106.09	8.725-357.0 (3)	\$50.62	9.803-935.0 (3)	\$45.54	9.803-936.0 (1)	\$59.02	9.803-937.0 (1)	\$7.66
GE2825F.1	8.725-354.0 (1)	\$75.45	8.725-355.0 (3)	\$41.72	9.803-934.0 (3)	\$39.96	9.803-936.0 (1)	\$59.02	9.803-937.0 (1)	\$7.66
GE2825S.1	8.725-356.0 (1)	\$106.09	8.725-357.0 (3)	\$50.62	9.803-935.0 (3)	\$45.54	9.803-936.0 (1)	\$59.02	9.803-937.0 (1)	\$7.66
GE3525F.1	8.725-354.0 (1)	\$75.45	8.725-355.0 (3)	\$41.72	9.803-934.0 (3)	\$39.96	9.803-936.0 (1)	\$59.02	9.803-937.0 (1)	\$7.66
GF2030F	8.754-860.0 (1)	CALL	8.754-861.0 (3)	CALL	8.754-862.0 (3)	CALL	8.754-859.0 (1)	CALL	9.803-937.0 (1)	\$7.66
GF2030S	8.754-856.0 (1)	CALL	8.754-857.0 (3)	CALL	8.754-858.0 (3)	CALL	8.754-859.0 (1)	CALL	9.803-937.0 (1)	\$7.66
GF2830F	8.754-860.0 (1)	CALL	8.754-861.0 (3)	CALL	8.754-862.0 (3)	CALL	8.754-859.0 (1)	CALL	9.803-937.0 (1)	\$7.66
GF2830S	8.754-856.0 (1)	CALL	8.754-857.0 (3)	CALL	8.754-858.0 (3)	CALL	8.754-859.0 (1)	CALL	9.803-937.0 (1)	\$7.66
GF3530F	8.754-860.0 (1)	CALL	8.754-861.0 (3)	CALL	8.754-862.0 (3)	CALL	8.754-859.0 (1)	CALL	9.803-937.0 (1)	\$7.66
GG2530G.1	8.725-354.0 (1)	\$75.45	8.725-355.0 (3)	\$41.72	9.803-934.0 (3)	\$39.96	9.803-936.0 (1)	\$59.02	9.803-937.0 (1)	\$7.66
GG3030G.1	8.725-354.0 (1)	\$75.45	8.725-355.0 (3)	\$41.72	9.803-934.0 (3)	\$39.96	9.803-936.0 (1)	\$59.02	9.803-937.0 (1)	\$7.66
GG3035G.1.1	8.725-354.0 (1)	\$75.45	8.725-355.0 (3)	\$41.72	9.803-934.0 (3)	\$39.96	9.803-936.0 (1)	\$59.02	9.803-937.0 (1)	\$7.66
GG3535G.1.1	8.725-354.0 (1)	\$75.45	8.725-355.0 (3)	\$41.72	9.803-934.0 (3)	\$39.96	9.803-936.0 (1)	\$59.02	9.803-937.0 (1)	\$7.66
GG4030G.1.1	8.725-354.0 (1)	\$75.45	8.725-355.0 (3)	\$41.72	9.803-934.0 (3)	\$39.96	9.803-936.0 (1)	\$59.02	9.803-937.0 (1)	\$7.66
GH5050	9.804-492.0 (1)	\$122.13	9.804-493.0 (3)	\$62.57	9.802-629.0 (3)	\$60.26	9.802-604.0 (1)	\$68.93	9.802-606.0 (1)	\$16.97
GM3540.2	8.725-358.0 (1)	\$78.69	8.725-359.0 (3)	\$46.61	8.933-023.0 (3)	\$34.25	9.802-603.0 (1)	\$60.77	9.802-609.0 (1)	\$17.09
GM3540.3	8.725-358.0 (1)	\$78.69	8.725-359.0 (3)	\$46.61	8.933-023.0 (3)	\$34.25	9.802-603.0 (1)	\$60.77	9.802-609.0 (1)	\$17.09
GM4030.2	8.725-362.0 (1)	\$72.31	8.725-363.0 (3)	\$44.09	9.802-620.0 (3)	\$61.22	9.802-603.0 (1)	\$60.77	9.802-609.0 (1)	\$17.09
GM4030.3	8.725-362.0 (1)	\$72.31	8.725-363.0 (3)	\$44.09	8.751-238.0 (3)	\$56.87	9.802-603.0 (1)	\$60.77	9.802-609.0 (1)	\$17.09
GM4035.2	8.725-360.0 (1)	\$92.47	8.725-361.0 (3)	\$46.21	9.802-629.0 (3)	\$60.26	9.802-603.0 (1)	\$60.77	9.802-609.0 (1)	\$17.09
GM4035.3	8.725-360.0 (1)	\$92.47	8.725-361.0 (3)	\$46.21	8.751-237.0 (3)	\$54.13	9.802-603.0 (1)	\$60.77	9.802-609.0 (1)	\$17.09
GM5030.2	8.725-362.0 (1)	\$72.31	8.725-363.0 (3)	\$44.09	9.802-620.0 (3)	\$61.22	9.802-603.0 (1)	\$60.77	9.802-609.0 (1)	\$17.09
GM5030.3	8.725-362.0 (1)	\$72.31	8.725-363.0 (3)	\$44.09	8.751-238.0 (3)	\$56.87	9.802-603.0 (1)	\$60.77	9.802-609.0 (1)	\$17.09
GM6035.2	8.725-360.0 (1)	\$92.47	8.725-361.0 (3)	\$46.21	9.802-629.0 (3)	\$60.26	9.802-603.0 (1)	\$60.77	9.802-609.0 (1)	\$17.09
GM6035.3	8.725-360.0 (1)	\$92.47	8.725-361.0 (3)	\$46.21	8.751-237.0 (3)	\$54.13	9.802-603.0 (1)	\$60.77	9.802-609.0 (1)	\$17.09
GP2535G	8.754-860.0 (1)	CALL	8.754-861.0 (3)	CALL	8.754-862.0 (3)	CALL	8.754-859.0 (1)	CALL	9.803-937.0 (1)	\$7.66
GP3035G	8.754-860.0 (1)	CALL	8.754-861.0 (3)	CALL	8.754-862.0 (3)	CALL	8.754-859.0 (1)	CALL	9.803-937.0 (1)	\$7.66
GP3035G1	8.754-860.0 (1)	CALL	8.754-861.0 (3)	CALL	8.754-862.0 (3)	CALL	8.754-859.0 (1)	CALL	9.803-937.0 (1)	\$7.66
GP3535G1	8.754-860.0 (1)	CALL	8.754-861.0 (3)	CALL	8.754-862.0 (3)	CALL	8.754-859.0 (1)	CALL	9.803-937.0 (1)	\$7.66
GP4035G1	8.754-860.0 (1)	CALL	8.754-861.0 (3)	CALL	8.754-862.0 (3)	CALL	8.754-859.0 (1)	CALL	9.803-937.0 (1)	\$7.66
GS3040G.2	8.725-358.0 (1)	\$78.69	8.725-359.0 (3)	\$46.61	8.933-023.0 (3)	\$34.25	9.802-603.0 (1)	\$60.77	9.802-609.0 (1)	\$17.09
GS3040G.3	8.725-358.0 (1)	\$78.69	8.725-359.0 (3)	\$46.61	8.933-023.0 (3)	\$34.25	9.802-603.0 (1)	\$60.77	9.802-609.0 (1)	\$17.09
GS3540G.2	8.725-358.0 (1)	\$78.69	8.725-359.0 (3)	\$46.61	8.933-023.0 (3)	\$34.25	9.802-603.0 (1)	\$60.77	9.802-609.0 (1)	\$17.09
GS3540G.3	8.725-358.0 (1)	\$78.69	8.725-359.0 (3)	\$46.61	8.933-023.0 (3)	\$34.25	9.802-603.0 (1)	\$60.77	9.802-609.0 (1)	\$17.09
GS4040G.2	8.725-358.0 (1)	\$78.69	8.725-359.0 (3)	\$46.61	8.933-023.0 (3)	\$34.25	9.802-603.0 (1)	\$60.77	9.802-609.0 (1)	\$17.09
GS4040G.3	8.725-358.0 (1)	\$78.69	8.725-359.0 (3)	\$46.61	8.933-023.0 (3)	\$34.25	9.802-603.0 (1)	\$60.77	9.802-609.0 (1)	\$17.09
GS5030G.2	8.725-358.0 (1)	\$78.69	8.725-359.0 (3)	\$46.61	8.933-023.0 (3)	\$34.25	9.802-603.0 (1)	\$60.77	9.802-609.0 (1)	\$17.09
GS5030G.3	8.725-358.0 (1)	\$78.69	8.725-359.0 (3)	\$46.61	8.933-023.0 (3)	\$34.25	9.802-603.0 (1)	\$60.77	9.802-609.0 (1)	\$17.09

Pump Model	Seal Kit		Complete Seal Kit		Ceramic Plunger Kit		Valve Kit		Plunger Oil Seal Kit	
	(qty per pump)	List Price	(qty per pump)	List Price	(qty per pump)	List Price	(qty per pump)	List Price	(qty per pump)	List Price
GT4540.2L	8.753-821.0 (1)	\$71.05	8.753-822.0 (3)	\$47.10	8.753-823.0 (3)	\$28.20	8.753-824.0 (1)	\$43.45	8.752-835.0 (1)	\$4.76
GT4540.2R	8.753-821.0 (1)	\$71.05	8.753-822.0 (3)	\$47.10	8.753-823.0 (3)	\$28.20	8.753-824.0 (1)	\$43.45	8.752-835.0 (1)	\$4.76
GT5635.1	8.916-488.0 (1)	\$90.38	8.916-322.0 (3)	\$58.45	9.802-607.0 (3)	\$70.86	9.802-603.0 (1)	\$60.77	9.802-606.0 (1)	\$16.97
GT5636.2L	8.753-821.0 (1)	\$71.05	8.753-822.0 (3)	\$47.10	8.753-823.0 (3)	\$28.20	8.753-824.0 (1)	\$43.45	8.752-835.0 (1)	\$4.76
GT5636.2R	8.753-821.0 (1)	\$71.05	8.753-822.0 (3)	\$47.10	8.753-823.0 (3)	\$28.20	8.753-824.0 (1)	\$43.45	8.752-835.0 (1)	\$4.76
GT6036.2L	8.753-821.0 (1)	\$71.05	8.753-822.0 (3)	\$47.10	8.753-823.0 (3)	\$28.20	8.753-824.0 (1)	\$43.45	8.752-835.0 (1)	\$4.76
GT6036.2R	8.753-821.0 (1)	\$71.05	8.753-822.0 (3)	\$47.10	8.753-823.0 (3)	\$28.20	8.753-824.0 (1)	\$43.45	8.752-835.0 (1)	\$4.76
GX1025.1	8.725-364.0 (1)	\$124.63	8.725-365.0 (3)	\$63.91	9.802-614.0 (3)	\$73.18	9.802-608.0 (1)	\$75.34	9.802-606.0 (1)	\$16.97
GX1036.2L	8.752-844.0 (1)	\$66.05	8.752-850.0 (3)	\$32.40	8.752-839.0 (3)	\$29.05	8.752-853.0 (1)	\$10.80	8.752-835.0 (1)	\$4.76
GX1036.2R	8.752-844.0 (1)	\$66.05	8.752-850.0 (3)	\$32.40	8.752-839.0 (3)	\$29.05	8.752-853.0 (1)	\$10.80	8.752-835.0 (1)	\$4.76
GX1622.2L	8.752-845.0 (1)	\$89.80	8.752-851.0 (3)	\$44.70	8.752-840.0 (3)	\$29.50	8.717-589.0 (1)	\$26.30	8.752-835.0 (1)	\$4.76
GX1622.2R	8.752-845.0 (1)	\$89.80	8.752-851.0 (3)	\$44.70	8.752-840.0 (3)	\$29.50	8.717-589.0 (1)	\$26.30	8.752-835.0 (1)	\$4.76
GX5450L	8.753-512.0 (1)	\$53.25	8.753-513.0 (3)	\$39.23	8.753-514.0 (3)	\$21.17	8.753-515.0 (1)	\$152.15	8.752-835.0 (1)	\$4.76
GX5450R	8.753-512.0 (1)	\$53.25	8.753-513.0 (3)	\$39.23	8.753-514.0 (3)	\$21.17	8.753-515.0 (1)	\$152.15	8.752-835.0 (1)	\$4.76
GX8030.1	8.725-364.0 (1)	\$124.63	8.725-365.0 (3)	\$63.91	9.802-614.0 (3)	\$73.18	9.802-608.0 (1)	\$75.34	9.802-606.0 (1)	\$16.97
GX9536.2L	8.752-844.0 (1)	\$66.05	8.752-850.0 (3)	\$32.40	8.752-839.0 (3)	\$29.05	8.752-853.0 (1)	\$10.80	8.752-835.0 (1)	\$4.76
GX9536.2R	8.752-844.0 (1)	\$66.05	8.752-850.0 (3)	\$32.40	8.752-839.0 (3)	\$29.05	8.752-853.0 (1)	\$10.80	8.752-835.0 (1)	\$4.76
HFR105SL	8.754-245.0 (1)	\$256.49	8.754-244.0 (3)	\$136.19	8.754-242.0 (3)	\$101.94	8.754-243.0 (1)	\$37.12	8.754-235.0 (1)	\$8.99
HFR105SR	8.754-245.0 (1)	\$256.49	8.754-244.0 (3)	\$136.19	8.754-242.0 (3)	\$101.94	8.754-243.0 (1)	\$37.12	8.754-235.0 (1)	\$8.99
HFR120SL	8.754-245.0 (1)	\$256.49	8.754-244.0 (3)	\$136.19	8.754-242.0 (3)	\$101.94	8.754-243.0 (1)	\$37.12	8.754-235.0 (1)	\$8.99
HFR120SR	8.754-245.0 (1)	\$256.49	8.754-244.0 (3)	\$136.19	8.754-242.0 (3)	\$101.94	8.754-243.0 (1)	\$37.12	8.754-235.0 (1)	\$8.99
HFR40FL	8.754-231.0 (1)	\$129.07	8.754-232.0 (3)	\$103.98	8.754-233.0 (3)	\$75.41	8.754-243.0 (1)	\$37.12	8.754-235.0 (1)	\$8.99
HFR40FR	8.754-231.0 (1)	\$129.07	8.754-232.0 (3)	\$103.98	8.754-233.0 (3)	\$75.41	8.754-243.0 (1)	\$37.12	8.754-235.0 (1)	\$8.99
HFR40SL	8.754-231.0 (1)	\$129.07	8.754-232.0 (3)	\$103.98	8.754-233.0 (3)	\$75.41	8.754-243.0 (1)	\$37.12	8.754-235.0 (1)	\$8.99
HFR40SR	8.754-231.0 (1)	\$129.07	8.754-232.0 (3)	\$103.98	8.754-233.0 (3)	\$75.41	8.754-243.0 (1)	\$37.12	8.754-235.0 (1)	\$8.99
HFR60FL	8.754-231.0 (1)	\$129.07	8.754-232.0 (3)	\$103.98	8.754-233.0 (3)	\$75.41	8.754-243.0 (1)	\$37.12	8.754-235.0 (1)	\$8.99
HFR60FR	8.754-231.0 (1)	\$129.07	8.754-232.0 (3)	\$103.98	8.754-233.0 (3)	\$75.41	8.754-243.0 (1)	\$37.12	8.754-235.0 (1)	\$8.99
HFR60SL	8.754-231.0 (1)	\$129.07	8.754-232.0 (3)	\$103.98	8.754-233.0 (3)	\$75.41	8.754-243.0 (1)	\$37.12	8.754-235.0 (1)	\$8.99
HFR60SR	8.754-231.0 (1)	\$129.07	8.754-232.0 (3)	\$103.98	8.754-233.0 (3)	\$75.41	8.754-243.0 (1)	\$37.12	8.754-235.0 (1)	\$8.99
HFR80FL	8.754-231.0 (1)	\$129.07	8.754-232.0 (3)	\$103.98	8.754-233.0 (3)	\$75.41	8.754-234.0 (1)	\$37.12	8.754-235.0 (1)	\$8.99
HFR80FR	8.754-231.0 (1)	\$129.07	8.754-232.0 (3)	\$103.98	8.754-233.0 (3)	\$75.41	8.754-234.0 (1)	\$37.12	8.754-235.0 (1)	\$8.99
HFR80SL	8.754-245.0 (1)	\$256.49	8.754-244.0 (3)	\$136.19	8.754-242.0 (3)	\$101.94	8.754-243.0 (1)	\$37.12	8.754-235.0 (1)	\$8.99
HFR80SR	8.754-245.0 (1)	\$256.49	8.754-244.0 (3)	\$136.19	8.754-242.0 (3)	\$101.94	8.754-243.0 (1)	\$37.12	8.754-235.0 (1)	\$8.99
HHP25SL	8.754-236.0 (1)	\$87.76	8.754-237.0 (3)	\$58.21	8.754-246.0 (1)	\$77.53	8.754-241.0 (1)	\$28.39	8.754-235.0 (1)	\$8.99
HHP25SR	8.754-236.0 (1)	\$87.76	8.754-237.0 (3)	\$58.21	8.754-246.0 (1)	\$77.53	8.754-241.0 (1)	\$28.39	8.754-235.0 (1)	\$8.99
HHP2750R	8.754-236.0 (1)	\$87.76	8.754-240.0 (3)	\$58.21	8.754-246.0 (1)	\$77.53	8.754-247.0 (1)	\$29.12	8.754-235.0 (1)	\$8.99
HHP30SL	8.754-236.0 (1)	\$87.76	8.754-237.0 (3)	\$58.21	8.754-246.0 (1)	\$77.53	8.754-241.0 (1)	\$28.39	8.754-235.0 (1)	\$8.99
HHP30SR	8.754-236.0 (1)	\$87.76	8.754-237.0 (3)	\$58.21	8.754-246.0 (1)	\$77.53	8.754-241.0 (1)	\$28.39	8.754-235.0 (1)	\$8.99
HHP3650L	8.754-236.0 (1)	\$87.76	8.754-240.0 (3)	\$59.31	8.754-246.0 (1)	\$77.53	8.754-247.0 (1)	\$29.12	8.754-235.0 (1)	\$8.99
HHP3650R	8.754-236.0 (1)	\$87.76	8.754-240.0 (3)	\$59.31	8.754-246.0 (1)	\$77.53	8.754-247.0 (1)	\$29.12	8.754-235.0 (1)	\$8.99
HHP38FL	8.754-236.0 (1)	\$87.76	8.754-237.0 (3)	\$58.21	8.754-246.0 (1)	\$77.53	8.755-233.0 (1)	CALL	8.754-235.0 (1)	\$8.99
HHP38FR	8.754-236.0 (1)	\$87.76	8.754-237.0 (3)	\$58.21	8.754-246.0 (1)	\$77.53	8.755-233.0 (1)	CALL	8.754-235.0 (1)	\$8.99
HHP4150L	8.754-236.0 (1)	\$87.76	8.754-240.0 (3)	\$59.31	8.754-246.0 (1)	\$77.53	8.754-247.0 (1)	\$29.12	8.754-235.0 (1)	\$8.99
HHP4150R	8.754-236.0 (1)	\$87.76	8.754-240.0 (3)	\$59.31	8.754-246.0 (1)	\$77.53	8.754-247.0 (1)	\$29.12	8.754-235.0 (1)	\$8.99
HHP5040L	8.754-236.0 (1)	\$87.76	8.754-240.0 (3)	\$59.31	8.754-246.0 (1)	\$77.53	8.754-247.0 (1)	\$29.12	8.754-235.0 (1)	\$8.99
HHP5040R	8.754-236.0 (1)	\$87.76	8.754-240.0 (3)	\$59.31	8.754-246.0 (1)	\$77.53	8.754-247.0 (1)	\$29.12	8.754-235.0 (1)	\$8.99
HHP5750L	8.754-236.0 (1)	\$87.76	8.754-240.0 (3)	\$59.31	8.754-246.0 (1)	\$77.53	8.754-247.0 (1)	\$29.12	8.754-235.0 (1)	\$8.99
HY1515	8.754-979.0 (1)	\$20.24	8.754-981.0 (3)	\$16.79	8.754-983.0 (1)	\$33.64	8.754-577.0 (1)	\$14.39	9.803-937.0 (1)	\$7.66
HY1520	8.754-980.0 (1)	\$35.81	8.754-982.0 (3)	\$22.01	8.754-983.0 (1)	\$33.64	8.754-577.0 (1)	\$14.39	9.803-937.0 (1)	\$7.66
NMT1520CWR	8.754-239.0 (1)	\$57.53	8.754-229.0 (3)	\$60.57	8.754-261.0 (1)	\$6.24	8.754-276.0 (1)	\$7.03	8.754-261.0 (1)	\$6.24
NMT1520SCWR	8.754-239.0 (1)	\$57.53	8.754-229.0 (3)	\$60.57	8.754-261.0 (1)	\$6.24	8.754-276.0 (1)	\$7.03	8.754-261.0 (1)	\$6.24
NMT2120CWR	8.754-239.0 (1)	\$57.53	8.754-229.0 (3)	\$60.57	8.754-261.0 (1)	\$6.24	8.754-276.0 (1)	\$7.03	8.754-261.0 (1)	\$6.24
NMT2120ESR	8.754-239.0 (1)	\$57.53	8.754-229.0 (3)	\$60.57	8.754-256.0 (1)	\$32.96	8.754-230.0 (1)	\$8.69	8.754-261.0 (1)	\$6.24

Seal Kits



for **Legacy^{HD}**

Part #	Kit - Packing	List Price
8.725-355.0	U Seal, 15mm	\$41.72
8.725-357.0	U Seal, 18mm	\$50.62
8.725-359.0	U Seal, 15mm	\$46.61
8.725-361.0	U Seal, 18mm	\$46.21
8.725-363.0	U Seal, 20mm	\$44.09
8.725-365.0	U Seal, 25mm	\$63.91
9.804-493.0	U Seal, 18mm	\$62.57
8.916-322.0	U Seal, 20mm	\$58.45

Pump Valve Kits



for **Legacy^{HD}**

Part #	Kit Description	List Price
9.802-603.0	Valve Complete	\$60.77
9.802-604.0	Valve Complete	\$68.93
9.802-608.0	Valve Complete	\$75.34
9.803-936.0	Valve Complete	\$59.02

Complete Seal Kits



for **Legacy^{HD}**

Part #	Kit Description	List Price
8.725-354.0	15mm U Seal	\$75.45
8.725-356.0	18mm U Seal	\$106.09
8.725-358.0	15mm U Seal	\$78.69
8.725-360.0	18mm U Seal	\$92.47
8.725-362.0	20mm U Seal	\$72.31
8.725-364.0	25mm U Seal	\$124.63
8.725-358.0	15mm U Seal	\$78.69
9.804-492.0	18mm U Seal	\$122.13

Pump Rails

for **Legacy^{HD}**

Part #	Description	List Price
8.717-577.0	Heavy Duty Pump Rail	\$28.98

Plunger Oil Seal Kits



for **Legacy^{HD}**

Part #	Kit Description	List Price
9.802-606.0	Kit, Plunger Oil Seals	\$16.97
9.802-609.0	Kit, Plunger Oil Seals	\$17.09
9.803-937.0	Kit, Plunger Oil Seals	\$7.66

Pump Selection Chart for Legacy HD Direct Drive Pumps

for **Legacy^{HD}**

Motor	Engine	Pump	Unloader	Nozzle	GPM / PSI
9.802-339.0 2HP, 3450rpm		8.904-933.0 GE2020F.1	9.803-899.0 VBA35, Direct	# 3	1.9 / 1500
9.804-517.0 2HP, 1725rpm		8.904-934.0 GE2020S.1	9.803-899.0 VBA35, Direct	# 3	1.9 / 1500
9.802-340.0 3HP, 3450rpm		8.904-936.0 GE2825F.1	9.803-899.0 VBA35, Direct	# 4	2.5 / 1600
8.715-090.0 3HP, 1725rpm		8.916-560.0 GE2825S.1	9.803-899.0 VBA35, Direct	# 4	2.5 / 1600
9.802-341.0 5HP, 3450rpm		8.904-938.0 GE3525F.1	9.803-899.0 VBA35, Direct	# 5	3.5 / 2000
	12.0 cu in 6.5HP	8.904-967.0 GG2530G.1	9.803-899.0 VBA35, Direct	# 3	2.5 / 2700
	16.5 cu in 9HP	8.904-969.0 GG3035G.1	9.803-899.0 VBA35, Direct	# 3.5	3 / 3000
	20.6 cu in 11HP	8.904-969.0 GG3035G.1	9.803-899.0 VBA35, Direct	# 3	2.8 / 3500
	23.7 cu in 13HP	8.916-558.0 GG3535G.1	9.803-899.0 VBA35, Direct	# 3.5	3.3 / 3500
	23.7 cu in 13HP	8.916-559.0 GG4030G.1	9.803-899.0 VBA35, Direct	# 4.5	3.9 / 3000
	23.7 cu in 13HP	8.904-970.0 GS3040G.2	8.715-483.0 VRT607, Remote	# 3	3 / 4000
	20.6 cu in 11HP	8.904-971.0 GS3540G.2	9.803-900.0 VBA35, Direct	# 4	3.5 / 3000
	23.7 cu in 13HP	8.904-972.0 GS4040G.2	8.715-483.0 VRT607, Remote	# 4	4 / 4000
	29.3 cu in 16HP	8.904-973.0 GS5030G.2	9.803-900.0 VBA35, Direct	# 5.5	4.8 / 3000

Ceramic Plunger Kits

for **Legacy^{HD}**



Part #	Kit Description	List Price
8.754-862.0	Kit, Plunger, 14mm	CALL
8.754-576.0	Kit, Plunger, 15mm	\$24.46
8.933-023.0	Kit, Plunger, 15mm	\$34.25
9.803-934.0	Kit, Plunger, 15mm	\$39.96
8.753-514.0	Kit, Plunger, 16mm	\$21.17
8.754-858.0	Kit, Plunger, 16mm	CALL
8.754-983.0	Kit, Plunger, 16mm	\$33.64
8.751-237.0	Kit, Plunger, 18mm	\$54.13
8.753-823.0	Kit, Plunger, 18mm	\$29.19
9.802-629.0	Kit, Plunger, 18mm	\$60.26
9.803-935.0	Kit, Plunger, 18mm	\$45.54
8.751-238.0	Kit, Plunger, 20mm	\$56.87
9.802-620.0	Kit, Plunger, 20mm	\$61.22
8.752-839.0	Kit, Plunger, 22mm	\$30.07
9.802-614.0	Kit, Plunger, 25mm	\$73.18
8.752-840.0	Kit, Plunger, 28mm	\$29.60

Pump Selection Chart for Legacy HD Belt Drive Units

Motor	Engine	Pump	Eng. Bushing	Mtr. Bushing	Eng/Mtr Pulley	Pump Pulley	Pump Bushing	Unloader	Nozzle	GPM / PSI
	16.5 cu in 9HP	8.904-940.0 GD3030R	9.802-399.0 H x 1"		9.802-384.0 2BK 40H	9.802-389.0 2BK 80H	9.802-402.0 H x 24mm	9.803-899.0 VBA35, Direct	# 3.5	3 / 3000
9.802-341.0 5HP, 3450RPM		8.904-940.0 GD3030R		9.803-897.0 H x 3/4"	9.802-371.0 2AK 32H	8.715-555.0 2AK 64H	9.802-402.0 H x 24mm	9.803-899.0 VBA35, Direct	# 3.5	3 / 3000
	9.8 cu in 5.5HP	8.916-557.0 GD4020R.1	9.803-897.0 H x 3/4"		9.804-047.0 2AK 34H	9.802-375.0 2AK 84H	9.802-402.0 H x 24mm	9.803-899.0 VBA35, Direct	# 5	3.5 / 2000
9.802-341.0 5HP, 3450RPM		8.916-557.0 GD4020R.1		9.803-897.0 H x 3/4"	9.803-298.0 2AK 30H	9.802-374.0 2AK 74H	9.802-402.0 H x 24mm	9.803-899.0 VBA35, Direct	# 5	3.5 / 2000
9.802-335.0 10HP 3ph, 1760RPM		8.904-941.0 GM4030R.2		9.802-401.0 H x 1-3/8"	9.802-384.0 2BK 40H	8.715-591.0 2BK 70H	9.802-402.0 H x 24mm	9.803-900.0 VBA35, Direct	# 4.5	3.9 / 3000
8.709-834.0 15 HP 3ph, 1760RPM		8.904-946.0 GM4035R.2		9.803-980.0 P1 x 1-5/8"	8.715-598.0 2TB40	8.715-582.0 2BK 47H	9.802-402.0 H x 24mm	9.803-900.0 VBA35, Direct	# 4	3.7 / 3500
	23.7 cu in 13HP	8.904-946.0 GM4035R.2	9.802-399.0 H x 1"		8.715-576.0 2BK 32H	9.802-390.0 2BK 90H	9.802-402.0 H x 24mm	9.803-900.0 VBA35, Direct	# 4	3.7 / 3500
9.802-335.0 10HP 3ph, 1760RPM		8.904-945.0 GM5030R.2		9.802-401.0 H x 1-3/8"	9.803-299.0 2BK 57H	9.802-388.0 2BK 67H	9.802-402.0 H x 24mm	9.803-900.0 VBA35, Direct	# 5.5	4.8 / 3000
	29.3 cu in 16HP	8.904-945.0 GM5030R.2	9.802-399.0 H x 1"		9.802-384.0 2BK 40H	9.802-390.0 2BK 90H	9.802-402.0 H x 24mm	9.803-900.0 VBA35, Direct	# 5.5	4.8 / 3000
	23.7 cu in 13HP	8.904-943.0 GM3540R.2	9.802-399.0 H x 1"		9.802-384.0 2BK 40H	9.802-389.0 2BK 80H	9.802-402.0 H x 24mm	8.715-483.0 VRT607, Remote	# 3	3 / 4000
	40.9 cu in 24HP	8.749-938.0 GM6035R.2	9.802-400.0 H x 1-1/8"		9.802-382.0 2BK 34H	9.802-385.0 2BK 70H	9.802-402.0 H x 24mm	8.715-483.0 VRT607, Remote	# 6	5.6 / 3500
8.709-834.0 15 HP 3ph, 1760RPM		8.749-938.0 GM6035R.2		8.709-834.0 P1 x 1-5/8"	8.715-598.0 2TB40	9.802-385.0 2BK 45H	9.802-402.0 H x 24mm	8.715-483.0 VRT607, Remote	# 6	5.6 / 3500
	40.9 cu in 24HP	8.904-962.0 GX8030R.1	9.802-405.0 P2 x 1-1/8"		9.802-392.0 3TB 34	9.802-395.0 3BK 80H	9.802-403.0 H x 25mm	8.715-483.0 VRT607, Remote	# 9	7.8 / 3000
8.730-515.0 20HP 3ph, 1760RPM		8.904-962.0 GX8030R.1		9.803-980.0 P1 x 1-5/8"	9.802-393.0 3TB 36	9.803-979.0 3BK 50H	9.802-403.0 H x 25mm	8.715-483.0 VRT607, Remote	# 9	7.8 / 3000
	37.5 cu in 20HP	8.904-966.0 GX1025R.1	9.802-405.0 P2 x 1-1/8"		9.802-393.0 3TB 36	9.802-395.0 3BK 80H	9.802-403.0 H x 25mm	8.715-508.0 VBXL 13gpm	# 14	10 / 2000
8.730-515.0 20HP 3ph, 1760RPM		8.904-966.0 GX1025R.1		9.803-980.0 P1 x 1-5/8"	9.802-393.0 3TB 36	8.715-613.0 3BK 45H	9.802-403.0 H x 25mm	8.715-508.0 VBXL 13gpm	# 14	10 / 2000
	40.9 cu in 24HP	8.904-966.0 GX1025R.1	9.802-405.0 P2 x 1-1/8"		9.802-393.0 3TB 36	9.802-395.0 3BK 80H	9.802-403.0 H x 25mm	8.715-508.0 VBXL 13gpm	# 13	10.3 / 2500
8.730-515.0 20HP 3ph, 1760RPM		8.749-523.0 GH5050R		9.803-980.0 P1 x 1-5/8"	9.802-394.0 3TB 40	9.803-979.0 3BK 50H	9.802-403.0 H x 25mm	9.802-360.0 VB350/4	# 5	5 / 5000
	40.9 cu in 24HP	8.749-523.0 GH5050R	9.802-405.0 P2 x 1-1/8"		9.802-394.0 3TB 40	9.802-396.0 3BK 90H	9.802-403.0 H x 25mm	9.802-360.0 VB350/4	# 5	5 / 5000

**For best value, look for these
and other Legacy and A+ products
throughout the catalog**



Legacy HD Pump Cross Reference / Comparison Chart



Legacy HD Pumps	Legacy Pumps	General Pumps	AR Pumps
N/A	HG-2425	TH-2520G	XJV2.5G22D-F7
GG2530G.1	HG-2530	TH-3020G	XJV3G22D-F7

Legacy HD Pumps	Legacy Pumps	General Pumps	AR Pumps
N/A	WJG-2521	TP-2520J34	XTV2G22D-F7
N/A	WJG-2525	TP-2526J34	N/A
GG2530G.1	WJG-2530	TP-2530J34	XTV3G22D-F7
N/A	WJG-2535	TP-2533J34	N/A

Legacy HD Pumps	Legacy Pumps	General Pumps	AR Pumps
N/A	WJH-2521-F	TT-2021EBF	XTV2G22E-F8
N/A	WJH-2525-F	TT-2028EBG	N/A
GE2825F.1	WJH-2530-F	N/A	XTV3G22E-F8

GE2020S.1	WJH-2121	T-9051EBF	XTA2G15EBA-F8
N/A	WJH-2132	TT-9111EBF	XTA2G19E-F8

Legacy HD Pumps	Legacy Pumps	General Pumps	AR Pumps
N/A	WMG-2625	TX-1505G6	XMV2.5G26D-F25
GG2530G.1	WMG-2530	TX-1506G6	XMV3G25D-F25
N/A	WMG-2535	N/A	XMV3.5G25D-F25
N/A	WMG-2540	N/A	N/A

Legacy HD Pumps	Legacy Pumps	General Pumps	AR Pumps
GS3040G.2	WMG-3530 (1"H)	TX-1508G8	XMV3G30D-F24
GS3540G.2	WMG-3535 (1"H)	N/A	XMV3.5G30D-F24
GS4040G.2	WMG-3540 (1"H)	TX-1510G8	XMV4G32D-F24

Legacy HD Pumps	Legacy Pumps	General Pumps	AR Pumps
GE2020F.1 / GE2825F.1	WMH-2521-F	N/A	XMV2G25E-F33
GE2825F.1	WMH-2230-F	N/A	N/A
GE2825F.1	WMH-2035-F	N/A	N/A
N/A	WMH-1840-F	N/A	N/A
GE3525F.1	WMHS-2035-F (3/4"H)	TT-2035EBF	XMV3.5G25D-F33

GE2020S.1 / GE2925S.1	WMH-2021	N/A	XMA2G22E-F33
GE2825S.1	WMH-2525	N/A	XMA2.5G18E-F33
GE2825S.1	WMH-2528	N/A	XMA3G18E-F33
N/A	WMH-2035	N/A	N/A
N/A	WMHS-2035 (3/4"H)	N/A	N/A

Legacy HD Pumps	Legacy Pumps	General Pumps	AR Pumps
GD3025.1	WML-2530	TX-1812S17	XM11.17N
GM4030.2	WML-2534	TX-1812S17	XM13.20N
GM4030.2	WML-2540	TX-1812S17	XM15.15N



GS Series



GG Series

Legacy Pumps	Legacy Pumps	General Pumps	AR Pumps
GG3535G.1	TMG-3535	EZ-4035G34	RKV3.5G40HD-F24
GG4040G.2	TMG-4040	EZ-4040G34	RKV4G40HD-F24
N/A	TMG-4045	EZ-3045G	RKV4.5G40HD-F24
N/A	TMG-4050	N/A	N/A
N/A	TMG-3555	N/A	RKV5.5G40HD-F24

Legacy HD Pumps	Legacy Pumps	General Pumps	AR Pumps
N/A	TMH-3035	EZ-2536E	RKA3.5G30E-F17
N/A	TMH-3040	EZ-2542E	RKA4G30E-F17
N/A	TMH-3050	N/A	N/A
N/A	TMH-3055	N/A	RKA5.5G13E-F17

Legacy HD Pumps	Legacy Pumps	General Pumps	AR Pumps
GM4035.2	TML-3538	TS-1511	RK14.16N
GM4035.2	TML-3045	TS-921	RK14.16N
GM4035.2	TML-3545	N/A	RK14.16N
GT5635.1	TML-3053	TS-2021	RK21.20N
GM6035.2	TMS-3060	N/A	N/A

Legacy Pumps – Belt Drive Units



HFR Series

HFR SERIES:

- 1"-1-1/4" inlet x 3/4" outlet

Legacy

Part #	Model No.	GPM	PSI	HP	Shaft RPM	Weight Dia	Inlet	Outlet	(lbs)	List Price
8.751-672.0	HFR40SL	10.6	4100	29.8	1000	40mm	1"	3/4"	106 lbs	\$4,075.00
8.751-673.0	HFR40SR	10.6	4100	29.8	1000	40mm	1"	3/4"	106 lbs	\$4,075.00
8.751-674.0	HFR60SR	15.9	4100	44.7	1000	40mm	1"	3/4"	106 lbs	\$4,075.00
8.751-675.0	HFR60SL	15.9	4100	44.7	1000	40mm	1"	3/4"	106 lbs	\$4,075.00
8.751-676.0	HFR40FL	10.6	4100	29.8	1450	40mm	1"	3/4"	106 lbs	\$4,075.00
8.751-677.0	HFR40FR	10.6	4100	29.8	1450	40mm	1"	3/4"	106 lbs	\$4,075.00
8.751-678.0	HFR60FR	15.9	4100	44.7	1450	40mm	1"	3/4"	106 lbs	\$4,075.00
8.751-679.0	HFR60FL	15.9	4100	44.7	1450	40mm	1"	3/4"	106 lbs	\$4,075.00
8.751-680.0	HFR80FL	21.1	4100	59.3	1450	40mm	1"	3/4"	106 lbs	\$4,075.00
8.751-681.0	HFR80FR	21.1	4100	59.3	1450	40mm	1"	3/4"	106 lbs	\$4,075.00
8.751-688.0	HFR80SL	21.1	2200	31.8	1000	40mm	1-1/4"	3/4"	106 lbs	\$4,075.00
8.751-689.0	HFR80SR	21.1	2200	31.8	1000	40mm	1-1/4"	3/4"	106 lbs	\$4,075.00
8.751-690.0	HFR105SL	27.7	2200	41.7	1000	40mm	1-1/4"	3/4"	106 lbs	\$4,075.00
8.751-691.0	HFR105SR	27.7	2200	41.7	1000	40mm	1-1/4"	3/4"	106 lbs	\$4,075.00
8.751-692.0	HFR120SL	31.7	2200	47.8	1000	40mm	1-1/4"	3/4"	106 lbs	\$4,075.00
8.751-693.0	HFR120SR	31.7	2200	47.8	1000	40mm	1-1/4"	3/4"	106 lbs	\$4,075.00



HHP Series

HHP SERIES:

- 3/4" inlet x 1/2" outlet

Legacy

Part #	Model No.	GPM	PSI	HP	Shaft RPM	Weight Dia	(lbs)	List Price
8.751-682.0	HHP25SL	6.6	7250	32.8	1000	40mm	112 lbs	\$6,032.00
8.751-683.0	HHP25SR	6.6	7250	32.8	1000	40mm	112 lbs	\$6,032.00
8.751-684.0	HHP30SR	7.9	7250	39.2	1000	40mm	112 lbs	\$6,032.00
8.751-685.0	HHP30SL	7.9	7250	39.2	1000	40mm	112 lbs	\$6,032.00
8.751-686.0	HHP38FL	10	5000	34.2	1450	40mm	112 lbs	\$6,032.00
8.751-687.0	HHP38FR	10	5000	34.2	1450	40mm	112 lbs	\$6,032.00
8.751-694.0	HHP4150R	10.8	7250	53.6	1450	40mm	112 lbs	\$6,314.00
8.751-695.0	HHP4150L	10.8	7250	53.6	1450	40mm	112 lbs	\$6,314.00
8.751-696.0	HHP3650R	9.5	7250	47.2	1450	40mm	112 lbs	\$6,314.00
8.751-697.0	HHP3650L	9.5	7250	47.2	1450	40mm	112 lbs	\$6,314.00
8.751-698.0	HHP2750R	7.1	7250	35.3	1450	40mm	112 lbs	\$6,314.00
8.751-699.0	HHP5750L	7.1	7250	35.3	1450	40mm	112 lbs	\$6,314.00
8.751-700.0	HHP5040R	13.3	5800	52.8	1740	40mm	112 lbs	\$6,314.00
8.751-701.0	HHP5040L	13.3	5800	52.8	1740	40mm	112 lbs	\$6,314.00



NMT ES Series

NMT ES SERIES:

- 1/2" inlet x 3/8" outlet

Legacy

Part #	Model No.	GPM	PSI	HP	Shaft RPM	Weight Dia	(lbs)	List Price
8.754-112.0	NMT2120ESR	6.6	3000	13.6	1740	24mm	26 lbs	\$2,008.00



NMT Series

NMT SERIES:

- 1/2" inlet x 3/8" outlet

Legacy

Part #	Model No.	GPM	PSI	HP	Shaft RPM	Weight Dia	(lbs)	List Price
8.754-109.0	NMT15200CWR	4.7	3000	9.7	1740	24mm	21 lbs	\$708.00
8.754-110.0	NMT1520SCWR	4.8	3000	9.9	1200	24mm	21 lbs	\$708.00
8.754-111.0	NMT2120CWR	6.6	3000	13.6	1740	24mm	21 lbs	\$708.00

Legacy Pumps – Belt Drive Units



TML

TML SERIES: Industrial Triplex Plunger Pump with AI Connecting Rods

1450 RPM pulley drive with 24mm solid shaft, 1/2" inlet x 3/8" outlet, 18.9 lbs.

Compare to: General Pumps — the TS series and AR Pumps — RK series.

Part #	Original No.	Model No.	Shaft	GPM	PSI	RPM	List Price
8.703-382.0	105924	TML-3053	24mm	5.3	3000	1450	\$740.03
8.703-457.0	106756	Pump Rail Set (Kit)					\$54.60

NOTE: Can be run at 1750 RPM. Please note the pump ships without rails.



TTV

TTV SERIES: Heavy Industrial Triplex Plunger Pump with AI Connecting Rods

1450 RPM pulley drive with 24mm solid shaft, 3/4" inlet x 3/8" outlet, 31.9 lbs.

Compare to: General Pumps — the TS series and AR Pumps — RK series.

Part #	Original No.	Model No.	Shaft	GPM	PSI	RPM	List Price
8.703-387.0	105954	TTV-3555	24mm	5.5	3500	1450	\$1,070.19

NOTE: Can be run at 1750 RPM. Please note the pump ships without rails.



KKV

KKV SERIES: Heavy Industrial Triplex Plunger Pump with AI Connecting Rods

1450 RPM and 1725 RPM pulley drive with 30mm solid shaft, 1" inlet x 1/2" outlet, 39.6 lbs.

Part #	Original No.	Model No.	Shaft	GPM	PSI	RPM	List Price
8.703-391.0	105962	KKV-3087	30mm	8.7	3000	1725	\$1,740.87

Please note the pump ships without rails.

Pump Rails

Part #	Original No.	Description	List Price
8.900-756.0	108762	Heavy Duty Pump Rail – Short (set)	\$30.58
8.900-757.0	108763	Heavy Duty Pump Rail – Tall (set)	\$36.43

Legacy Pumps – Direct Drive Units



WJG

WJG SERIES: Triplex Plunger Pump with Bronze Connecting Rods

3450 RPM direct drive with 3/4" hollow shaft and SAE flange, 3/8" inlet x 3/8" outlet, 13.2 lbs.

Compare to: General Pumps — the TP series and AR Pumps — XTV series.

Part #	Original No.	Model No.	Shaft	GPM	PSI	RPM	List Price
8.703-342.0	105812	WJG-2525	3/4"H	2.5	2500	3450	\$573.39



WJH-F
and WJH

WJH-F SERIES: Triplex Plunger Pump with Bronze Connecting Rods

3450 RPM direct drive with 5/8" hollow shaft and NEMA 56C flange, 3/8" inlet x 3/8" outlet, 13.2 lbs.

Compare to: General Pumps — the TT series and AR Pumps — XTV series.

WJH SERIES: Triplex Plunger Pump with AI Connecting Rods

1725 RPM direct drive with 5/8" hollow shaft and NEMA 56C flange, 3/8" inlet x 3/8" outlet, 13.2 lbs.

Compare to: General Pumps — the T & TT series and AR Pumps — XTA series.

Part #	Original No.	Model No.	Shaft	GPM	PSI	RPM	List Price
WJH-F							
8.703-346.0	105822	WJH-2525-F	5/8"H	2.5	2500	3450	\$563.04
WJH							
8.703-348.0	105830	WJH-2121	5/8"H	2.1	2100	1725	\$577.53
8.703-349.0	105832	WJH-2132	5/8"H	3.2	2100	1725	\$576.50



WMG

WMG SERIES: Premium Triplex Plunger Pump with Bronze Connecting Rods

3450 RPM direct drive with 3/4" hollow shaft and SAE flange, 1/2" inlet x 3/8" outlet, 14.7 lbs.

Compare to: General Pumps — the TX series and AR Pumps — XMV series.

Part #	Original No.	Model No.	Shaft	GPM	PSI	RPM	List Price
8.703-351.0	105842	WMG-2530	3/4"H	3.0	2500	3450	\$633.42

Legacy Pumps – Direct Drive Units



WMG 1

WMG 1" SERIES: Premium Triplex Plunger Pump with Bronze Connecting Rods
3450 RPM direct drive with 1" hollow shaft and SAE flange, 1/2" inlet x 3/8" outlet, 14.7 lbs.
Compare to: General Pumps — the TX series and AR Pumps — XMV series.



Part #	Original No.	Model No.	Shaft	GPM	PSI	RPM	List Price
8.703-356.0	105854	WMG-3540	1"H	4.0	3500	3450	\$636.53



TMH

TMH SERIES: Industrial Triplex Plunger Pump with Al Connecting Rods
1725 RPM direct drive with 1-1/8" hollow shaft and NEMA flange, 1/2" inlet x 3/8" outlet, 18.9 lbs.
Compare to: General Pumps — the EZ series and AR Pumps — RKA series.



Part #	Original No.	Model No.	Shaft	GPM	PSI	RPM	List Price
8.703-375.0	105910	TMH-3035	1-1/8"H	3.5	3000	1725	\$881.82
8.703-376.0	105912	TMH-3040	1-1/8"H	4.0	3000	1725	\$783.50
8.703-377.0	105914	TMH-3050	1-1/8"H	5.0	3000	1725	\$881.82
8.703-378.0	105916	TMH-3055	1-1/8"H	5.5	3000	1725	\$898.38

Legacy Pump Repair Kit Selection Chart



Pump Model Series	MM	Check Valve Kit	Plunger Rod Oil Seal Kit	Water Seal(s) Only Kit	WaterSeal(s) Brass Ring Kit	Valve Cap Kit	Accessory Seal Kit
HDL	18	Kit 93	Kit 37	Kit 95	Kit 96	Kit 94	Kit 98
HG	15	Kit 84	Kit 64	Kit 129	Kit 92	Kit 66	N/A
KKV	22	Kit 40	Kit 37	Kit 90	Kit 87	Kit 132	Kit 98
KKV	25	Kit 40	Kit 37	Kit 91	Kit 88	Kit 100	Kit 98
KTV	20	Kit 123	Kit 37	Kit 89	Kit 86	Kit 99	Kit 98
TMG	15	Kit 123	Kit 65	Kit 74	Kit 69	Kit 67	Kit 78
TMH	18	Kit 123	Kit 65	Kit 76	Kit 71	Kit 67	Kit 78
TML	18	Kit 123	Kit 65	Kit 76	Kit 71	Kit 67	Kit 77
TML-F	15	Kit 123	Kit 65	Kit 74	Kit 69	Kit 67	Kit 77

Pump Model Series	MM	Check Valve Kit	Plunger Rod Oil Seal Kit	Water Seal(s) Only Kit	WaterSeal(s) Brass Ring Kit	Valve Cap Kit	Accessory Seal Kit
TMS	18	Kit 123	Kit 65	Kit 76	Kit 71	Kit 67	Kit 77
TTV	20	Kit 123	Kit 37	Kit 89	Kit 86	Kit 67	Kit 127
WJG	15	Kit 84	Kit 64	Kit 60	Kit 61	Kit 66	Kit 82
WJH-F	15	Kit 84	Kit 64	Kit 60	Kit 61	Kit 66	Kit 82
WJH	18	Kit 84	Kit 64	Kit 12	Kit 10	Kit 66	Kit 82
WMG-3/4"	15	Kit 124	Kit 64	Kit 73	Kit 68	Kit 67	Kit 80
WMG-1"	15	Kit 124	Kit 64	Kit 73	Kit 68	Kit 67	Kit 79
WMH-F	15	Kit 124	Kit 64	Kit 73	Kit 68	Kit 67	Kit 80
WMH	18	Kit 63	Kit 64	Kit 12	Kit 70	Kit 67	Kit 80
WML	18	Kit 63	Kit 64	Kit 12	Kit 70	Kit 67	Kit 81

Legacy Pump Repair Tool Kit



Part #	Description	List Price
9.802-954.0	Legacy Pump Repair Tool Kit	\$286.40

Part #	Description	List Price
9.802-564.0	Guide, Oil Seal Inserter, Plunger Rod GT-GX-GH	\$7.80
9.802-581.0	Piston, Oil Seal Inserter, Plunger Rod GT-GX-GH	\$14.00
9.802-580.0	Piston, Oil Seal Inserter, Plunger Rod GM-GD-GG-GE-GS	\$10.40
9.802-563.0	Guide, Oil Seal Inserter, Plunger Rod GM-GD-GG-GE-GS	\$6.30
9.802-571.0	Wrench, Allen 8mm, Manifold Bolts GT-GX-GH	\$3.90
9.802-567.0	Wrench, Allen 6mm, Manifold Bolts GM-GD-GG-GE-GS	\$3.20
9.802-570.0	Wrench, Allen 5mm, Crankcase Cover	\$2.70
9.802-565.0	Guide, Oil Seal Inserter, Crankshaft GT-GX-GH	\$12.10
9.802-566.0	Guide, Oil Seal Inserter, Crankshaft GM-GD-GG-GE-GS	\$8.60
9.802-568.0	Extractor, Piston Seal	\$70.50
9.802-579.0	Piston, Seal Inserter, Manifold GM-GS	\$9.30
9.802-573.0	Guide, Seal Inserter, Manifold GM-GS	\$16.00
9.802-578.0	Piston, Seal Inserter, Manifold GT	\$8.40
9.802-572.0	Guide, Seal Inserter, Manifold GT	\$16.00
8.751-396.0	Guide, Seal Inserter, Manifold GD-GE-GG	\$46.90
8.751-404.0	Guide, Seal Inserter, Manifold GX5050	\$25.60
8.751-397.0	Piston, Seal Inserter, Manifold GD-GE-GG-GH-GX	\$33.40
8.751-405.0	Guide, Seal Inserter, Manifold GH-GX	\$35.80
9.802-569.0	Hammer, Plastic Head	\$44.60
8.751-403.0	Screwdriver Flathead	\$12.70
9.802-574.0	Box, Plastic Tool Box	\$27.70

Legacy Pump Repair Kits



Part #	Original No.	Kit No.	Description	No. of Pieces	Quantity Needed Per Pump	List Price
8.703-458.0	106810	Kit 10	WJH Packing / Header / Brass Assy (18mm)	21	1	\$137.66
8.703-459.0	106812	Kit 12	WM-H&L Packing Kit WJH Packing / Header only (18mm)	15	1	\$79.95
9.803-041.0	106822	Kit 22	APR.S Unloader Seal(s) Kit	14	1	\$41.86
8.703-461.0	106837	Kit 37	TTV-KTV-HDL Plunger Oil Seal Kit	3	1	\$32.91
8.703-462.0	106840	Kit 40	KKV Check Valves / O-ring Kit	12	1	\$116.96
8.932-979.0	106842	Kit 42	APR.S Unloader Valve Seal Kit	3	1	\$22.88
8.900-701.0	106860	Kit 60	V-Packing,15mm Legacy Pump WJH WJH-F&G Packing / Header only (15mm)	12	1	\$62.98
8.900-702.0	106861	Kit 61	Complete Plunger Set 15mm 18PX WJH-F&G Packing / Header / Brass (15mm)	18	1	\$116.96
8.703-464.0	106863	Kit 63	WMH&L Check Valve / O-ring Kit	12	1	\$54.91
8.703-465.0	106864	Kit 64	HG / WJ / WM Plunger Oil Seal Kit	3	1	\$23.03
8.703-466.0	106865	Kit 65	TM Plunger Oil Seal Kit	3	1	\$26.08
8.703-467.0	106866	Kit 66	HG / WJ Valve Cap / O-ring (M18x1.5) Kit	12	1	\$57.29
8.703-468.0	106867	Kit 67	WM / TM / TTV Valve Cap / O-ring (M27x1.5)	12	1	\$104.54
8.703-469.0	106868	Kit 68	WM-F&G Packing / Brass Assy Kit (15mm)	21	1	\$129.38
8.703-470.0	106869	Kit 69	TM-F&G Packing / Brass Assy (15mm)	21	1	\$133.52
8.703-471.0	106870	Kit 70	WM-H&L Packing / Brass Assy Kit (18mm)	21	1	\$129.38
8.703-472.0	106871	Kit 71	TM-H&L Packing / Brass Assy Kit (18mm)	24	1	\$202.91
8.703-456.0	106755	Kit 72	WML Pump Rail Kit (Foot, Spacer, Bolt)	8	1	\$49.94
8.703-474.0	106873	Kit 73	WM-F&G Packing Only Kit (15mm)	15	1	\$62.10
8.703-475.0	106874	Kit 74	TM-F &G Packing Only Kit (15mm)	15	1	\$61.58
8.703-476.0	106876	Kit 76	TM-H&L Packing Only Kit (18mm)	18	1	\$112.82
8.703-477.0	106877	Kit 77	TM-S&L Accessory Seals Kit	8	1	\$54.80
8.703-478.0	106878	Kit 78	TM-G Accessory Seals Kit	8	1	\$59.51
8.703-479.0	106879	Kit 79	WM-G 1" Accessory Seals Kit	8	1	\$48.90
8.703-480.0	106880	Kit 80	WM-F&G-3/4" Accessory Seals Kit	8	1	\$58.37
8.703-481.0	106881	Kit 81	WM-L Accessory Seals Kit	8	1	\$57.91
8.703-482.0	106882	Kit 82	WJH-F Accessory Seals Kit	8	1	\$44.35
8.703-483.0	106884	Kit 84	HG / WJ Check Valve / O-ring Kit	12	1	\$55.99
8.703-485.0	106886	Kit 86	TTV-KTV Packing / Brass Assy Kit (20mm)	24	1	\$272.21
8.703-486.0	106887	Kit 87	KKV Packing / Brass Assy Kit (22mm)	24	1	\$283.59
8.703-487.0	106888	Kit 88	KKV Packing / Brass Assy Kit (25mm)	24	1	\$278.42
8.703-488.0	106889	Kit 89	TTV-KTV Packing Only Kit (20mm)	18	1	\$135.59
8.703-489.0	106890	Kit 90	KKV Packing Only Kit L90 (22mm)	18	1	\$167.67
8.703-490.0	106891	Kit 91	KKV Packing Only Kit L91 (25mm)	18	1	\$168.71
8.703-491.0	106892	Kit 92	HG Packing / Brass Assy Kit	21	1	\$345.69
8.703-492.0	106893	Kit 93	HDL Check Valve / O-ring Kit	12	1	\$76.49
8.703-493.0	106894	Kit 94	HDL Valve Containment Kit L94	24	1	\$164.57
8.900-703.0	106895	Kit 95	HDL Packing Only Kit L95 (18mm)	18	1	\$115.92
8.703-494.0	106896	Kit 96	HDL Packing / Brass Assy Kit (18mm)	24	1	\$195.62
8.703-495.0	106898	Kit 98	KTV-KKV-HDL Accessory Seal Kit	8	1	\$69.81
8.703-496.0	106899	Kit 99	KTV Valve Cap / O-ring Kit (Plated)	12	1	\$141.80
8.703-497.0	106900	Kit 100	KKV Plated Valve Cap / O-ring Kit	12	1	\$186.30
8.703-498.0	106923	Kit 123	TM-TTV-KTV Check Valve / O-ring	12	1	\$66.49
8.703-499.0	106924	Kit 124	WM-F&G Check Valve / O-ring Kit	12	1	\$63.91
8.703-500.0	106926	Kit 126	APR-35/40 Seal Repair Kit	13	1	\$34.31
8.703-501.0	106927	Kit 127	TTV Accessory Oil Seal Kit	10	1	\$75.09
8.703-502.0	106929	Kit 129	HG Packing Only Kit (15mm)	12	1	\$66.81
8.703-503.0	106932	Kit 132	KKV Valve Cap / O-ring Kit	12	1	\$270.14

Admiral Pump Repair Kits

For the following Admiral pumps: WE Series; WEL Series; XD Series; XLS Series; CA Series; WG Series; XLE Series; XLG Series; C Series; IB Series

Part No.	Original No.	Kit No.	Description	Quantity Needed per Pump	List Price
8.900-631.0	106501	Kit AP1	Check Valves (For WE, WG, WEL, XL Series, XD Small Brass Head)	1	\$59.20
8.900-632.0	106502	Kit AP2	Brass Valve Covers (For WE, WG, WEL Series and XD Small Brass Head)	1	\$63.60
8.900-633.0	106504	Kit AP4	Oil Seals 15mm Plunger Rod (For WE, WG and WEL Series)	1	\$19.15
8.900-634.0	106505	Kit AP5	Oil Seals 18mm Plunger Rod (For XL Series)	1	\$20.91
8.900-635.0	106506	Kit AP6	Male Adapter Rings, 15mm (For WE and WG Series)	1	\$8.85
8.900-636.0	106507	Kit AP7	Male Adapter Rings, 18mm (For WEL, XLE and XLS Series)	1	\$12.42
8.900-637.0	106508	Kit AP8	V-Packing Seals, 15mm (For WE and WG Series)	1	\$39.23
8.900-638.0	106509	Kit AP9	V-Packing Seals, 18mm (For WEL Series Only)	1	\$41.24
8.900-639.0	106510	Kit AP10	Brass Packing Gland, 15mm (For WE and WG Series)	1	\$33.59
8.900-640.0	106511	Kit AP11	Brass Packing Gland, 18mm (For WEL Series)	1	\$29.03
8.900-641.0	106512	Kit AP12	Complete Plunger Seal, 15mm (For WE, and WG Series)	3	\$23.13
8.900-642.0	106513	Kit AP13	Complete Plunger Seal, 18mm (For WEL Series)	3	\$25.93
8.900-643.0	106514	Kit AP14	Brass Packing Gland, Two Piece, 18mm (For XLE, and XLS Series)	1	\$66.81
8.900-644.0	106515	Kit AP15	V-Packing Seals, Two Piece, 18mm (For XLE, and XLS Series)	1	\$79.64
8.900-645.0	106516	Kit AP16	Super U-Packing Seals, 18mm (For XLG Series Only)	1	\$97.29
8.900-646.0	106517	Kit AP17	Complete Plunger Seal, Two Piece, 18mm (For XLE, and XLS Series)	3	\$53.15
8.900-647.0	106518	Kit AP18	Complete Plunger Seal, Super-U, 18mm (For XLG Series Only)	3	\$65.26
8.900-648.0	106519	Kit AP19	Brass Packing Gland, Super-U, 18mm (For XLG Series Only)	1	\$70.12
8.900-649.0	106520	Kit AP20	Valve Covers, Brass (For XLG, XLE, XLS Series, and XD Small Plated Pump)	1	\$83.78
8.900-650.0	106521	Kit AP21	Valve Covers, Plated (For XLG, XLE, XLS, and XD Small Plated Pump)	1	\$142.83
8.900-651.0	106522	Kit AP22	Male Adapter Rings, 18mm (For XLG Series Only)	1	\$14.65
8.900-652.0	106523	Kit AP23	Low Pressure Seals, 18mm (For XL Series)	1	\$42.38
8.900-653.0	106524	Kit AP24	V-Packing Seals, 15mm, Two Piece (For WE-T and WG-T Series)	1	\$48.75
8.900-654.0	106525	Kit AP25	V-Packing Seals, 18mm, Two Piece (For WEL-T Series Only)	1	\$52.99
8.900-655.0	106526	Kit AP26	Brass Packing Gland, 15mm, Two Piece (For WE-T and WG-T Series)	1	\$85.54
8.900-656.0	106527	Kit AP27	Brass Packing Gland, 18mm, Two Piece (For WEL-T Series Only)	1	\$75.35
8.900-657.0	106528	Kit AP28	Complete Plunger Seal, 15mm, Two Piece (For WE-T, and WG-T Series)	3	\$41.04
8.900-658.0	106529	Kit AP29	Complete Plunger Seal, 18mm, Two Piece (For WEL-T Series Only)	3	\$47.87
8.900-659.0	106531	Kit AP31	Check Valve Kit (For XD Big Head)	1	\$121.10
8.900-660.0	106532	Kit AP32	Brass Valve Caps (For XD Big Head)	1	\$166.64
8.900-661.0	106533	Kit AP33	Plated Valve Caps (For XD Big Plated Head)	1	\$153.18
8.900-662.0	106534	Kit AP34	Plunger Rod Seal (For XD Pumps)	1	\$37.78
8.900-663.0	106535	Kit AP35	Male Adapter Rings (For XD 20mm)	1	\$26.13
8.900-664.0	106536	Kit AP36	Male Adapter Rings (For XD 22mm)	1	\$113.85
8.900-665.0	106537	Kit AP37	Male Adapter Rings (For XD 25mm)	1	\$61.63
8.900-666.0	106538	Kit AP38	"Super U" Packing (For XD 20mm)	1	\$126.27
8.900-667.0	106539	Kit AP39	"Super U" Packing (For XD 22mm)	1	\$122.13
8.900-668.0	106540	Kit AP40	"Super U" Packing (For XD 25mm)	1	\$150.08
8.900-669.0	106541	Kit AP41	Two Piece Brass Gland (For XD 20mm)	1	\$135.59
8.900-670.0	106542	Kit AP42	Two Piece Brass Gland (For XD 22mm)	1	\$129.38
8.900-671.0	106543	Kit AP43	Two Piece Brass Gland (For XD 25mm)	1	\$149.04
8.900-672.0	106544	Kit AP44	Complete Plunger Seal Repair (For XD 20mm)	3	\$80.16
8.900-673.0	106545	Kit AP45	Complete Plunger Seal Repair (For XD 22mm)	3	\$85.91
8.900-674.0	106546	Kit AP46	Complete Plunger Seal Repair (For XD 25mm)	3	\$124.20
8.900-675.0	106550	Kit AP50	Check Valve Kit (For C-Pumps, Brass Head)	1	\$283.59
8.900-676.0	106552	Kit AP52	Check Valve Assemblies (For IB-1000 Series, and CA Series)	1	\$275.01
8.900-678.0	106555	Kit AP55	Oil Seals, 45mm Plunger Rod (For IB-1000 Series, C and CA Series)	1	\$97.86
8.900-680.0	106557	Kit AP57	Male Adapter Rings, 45mm (For IB-1000 Series, C and CA Series)	1	\$24.48
8.900-682.0	106559	Kit AP59	V-Packing Seals, 45mm (For IB-1000 Series, C and CA Series)	1	\$230.72
8.900-683.0	106561	Kit AP61	Glands (45mm), Brass Packing (For IB-1019, 1032, 1037, C and CA Series)	1	\$266.00
8.900-685.0	106563	Kit AP63	Complete Plunger Seal, 45mm (For IB-1019, 1032, 1037, C and CA Series)	3	\$170.78
8.900-687.0	106566	Kit AP66	Packing Spacer Shim, 45mm (For IB-1000 / Shim)	1	\$46.68
8.900-691.0	106594	Kit AP94	Brass Packing Gland (30mm), (C-Series, 2200 PSI)	1	\$183.20
8.900-692.0	106595	Kit AP95	Complete Plunger Kit (30mm), (C-Series, 2200 PSI)	3	\$166.64
8.900-693.0	106596	Kit AP96	Male Adapter Kit (30mm), (C-Series, 2200 PSI)	1	\$21.89
8.900-694.0	106597	Kit AP97	V-Packing Kit (30mm), (C-Series, 2200 PSI)	1	\$159.39

Interpump / General Pumps



Solid-Shaft Pumps



8.702-629.0
Solid-Shaft Pumps



8.702-635.0



8.702-703.0

Part #	Old No.	Interpump Model No.	GP Model No.	GPM	PSI	RPM	Shaft Dia	List Price
8.702-629.0	102048	WS92	TS921	4.75	1800	1450	24mm	\$897.35
9.802-358.0	102052	W99	T991	3.5	1500	1450	24mm	\$733.65
8.702-625.0	102046	W92	T921	5.0	1700	1050	24mm	\$922.19
8.702-622.0	102042	WS82	TS821	5.6	1500	1450	24mm	\$965.66
8.702-636.0	102058	WS101	TS1011	4.0	2000	1450	24mm	\$912.58
8.702-635.0	102056	W101	T1011	4.5	2000	1125	24mm	\$917.73
8.702-646.0	102076	WS133	TS1331	3.5	2100	1450	24mm	\$940.82
8.702-645.0	102074	WS132	TS1321	4.75	2100	1450	24mm	\$1,001.88
8.702-643.0	102072	W132	T1321	5.5	2100	1150	24mm	\$918.05
8.702-650.0	102084	WS151	TSS1511s	4.0	3500	1450	24mm	\$982.00
8.702-649.0	102082	W151	T1511	4.5	2500	1125	24mm	\$987.39
8.702-655.0	102090	WS162	TS1621	4.75	2500	1450	24mm	\$1,138.50
8.702-654.0	102088	W162	T1621	5.0	2500	1050	24mm	\$1,112.63
8.702-665.0	102105	W201	T2011	4.5	3000	1125	24mm	\$1,160.24
8.702-667.0	102110	WS201	TS2011	4.0	3000	1450	24mm	\$1,130.94
8.702-670.0	102115G	WS202	TS2021	5.6	3500	1450	24mm	\$998.97
8.702-697.0	102157	W972	T9721	2.1	1000	1750	24mm	\$613.76
8.702-698.0	102162	W973	T9731	2.8	1100	1750	24mm	\$623.07
8.702-700.0	102167	W979	T9791	2.5	1100	1750	24mm	\$702.77
8.702-701.0	102170	W995	T9951	3.4	1300	1750	24mm	\$747.27
8.702-702.0	102174	W996	T9961	4.0	1100	1750	24mm	\$757.62
8.702-703.0	102176	W997	T9971	4.0	2000	1750	24mm	\$935.64
8.702-686.0	102135	W912	T9121	4.75	1500	1750	24mm	\$989.46
8.702-687.0	102140	W913	T9131	4.0	1900	1750	24mm	\$993.60
8.702-688.0	102145	W916	T9161	4.75	2300	1750	24mm	\$1,201.64
8.702-690.0	102150	W921	T9211	4.0	2900	1750	24mm	\$1,218.20
8.702-693.0	102152	W928	T9281	4.0	4000	1750	24mm	\$1,547.33
8.702-695.0	102154	T5050	T5050	5.0	5000	1845	24mm	\$2,226.08
8.702-661.0	102097	-	TT9111	3.0	1500	1750	24mm	\$633.42
8.702-630.0	102049	WW93	TT931	2.9	1500	2800	24mm	\$582.71
8.702-628.0	102047	WW94	TT941	3.43	1300	2800	24mm	\$544.41
8.702-685.0	102134	WW935	TT9351	3.5	2500	3400	24mm	\$870.44
8.702-663.0	102102	WW944	TT9441	4.4	2500	3400	24mm	\$863.19

*Duplex Pump



8.702-741.0
TX Solid-Shaft Pumps

TX Solid-Shaft Pump

Part #	Old No.	Model No.	GPM	PSI	RPM	Shaft Dia	List Price
8.702-741.0	102282	TX1510S34	4.0	3000	3400	24MM	\$737.96



8.702-768.0

Series "44" Solid-Shaft Pumps

Series "44" (EZ Series) Solid-Shaft Pumps

Part #	Old No.	Interpump Model No.	GP Model No.	GPM	PSI	RPM	Shaft Dia	List Price
8.702-766.0	102313	W956	EZ2536S	3.6	2500	1750	24mm	\$751.41
8.702-768.0	102317	W959	EZ2542S	4.2	2500	1750	24mm	\$736.92
8.702-773.0	102320	W186	EZ3040S	4.0	3000	3400	24mm	\$780.39
8.702-782.0	102333	-	EZ4040S34	4.0	4000	3400	24mm	\$978.08

NOTE: For Direct-Drive Mounting of the above pumps. See flanges on page 79.

Interpump / General Pumps



8.702-740.0
TSF Pumps

TSF

Part #	Old No.	Model No.	GPM	PSI	RPM	Shaft Dia	List Price
8.702-740.0	102281	TSF2021	7.0	3600	1450	24mm	\$1,557.36
8.702-736.0	102277	TSF2221	10.2	3000	1750	24mm	\$1,957.00
8.702-737.0	102278	TSF2421	12.0	2500	1750	24mm	\$2,472.00



8.702-652.0
Large Frame,
Solid-Shaft Pumps

Large Frame Solid-Shaft Pumps

Part #	Old No.	Interpump Model No.	GP Model No.	GPM	PSI	RPM	Shaft Dia	List Price
8.702-612.0	102004	W4A	T41A	12.0	900	650	35mm	\$1,786.41
8.702-640.0	102067	WS104	TS1041	8.0	1600	1450	35mm	\$2,022.39
8.702-652.0	102086	WS153	TS1531	8.0	2175	1450	35mm	\$2,706.84
8.702-648.0*	102079	WS135	TS1351	11.0	2000	1450	32mm	\$3,426.89
8.702-657.0	102092	W163	T1631	10.0	2500	1080	32mm	\$3,180.56
8.702-672.0	102120	W203	T2031	9.0	3000	1140	32mm	\$3,179.52
8.702-613.0	102006	W6	T61	17.0	1000	650	35mm	\$5,278.50
8.702-614.0	102008	W8	T81	21.0	1000	650	35mm	\$4,887.27
8.740-164.0	102012	W12	T121	35.0	1000	650	35mm	\$19,947.56

* Double-headed pump



8.702-754.0
Solid-Shaft
Car Wash Pumps

Solid-Shaft Car Wash Pumps

Part #	Old No.	Model No.	GPM	PSI	RPM	Shaft Dia	Ship Wt (lbs)	List Price
8.702-754.0	102295	CW2040	5.0	2500	1250	24mm	30	\$1,370.34
8.702-752.0	102293	CW24	5.0	2500	1250	24mm	30	\$1,428.30
8.702-745.0	102286	CW3040	5.0	3000	1250	24mm	32	\$1,352.75
8.702-748.0	102289	CW81	20.0	1200	1000	35mm	92	\$6,213.11



8.702-711.0
Gas Hollow-Shaft
Direct-Drive Pumps

Gas Hollow-Shaft Direct-Drive

Part #	Old No.	Interpump Model No.	GP Model No.	GPM	PSI	RPM	Shaft Dia	List Price
8.702-711.0	102206	WW906G	TT9061G	2.1	1400	3400	3/4"	\$653.09
8.702-712.0	102208	WW907G	TT9071G	2.8	1500	3400	3/4"	\$626.18
8.702-682.0	102130		TT1540GBF	4.0	1500	3400	3/4"	\$647.91
8.702-673.0	102121		TT2028GBF	2.8	2000	3400	3/4"	\$605.48
8.702-674.0	102122		TT2035GBF	3.5	2000	3400	3/4"	\$587.88

Interpump / General Pumps



Hollow-Shaft Direct-Drive — flanged for direct couple to electric motors

Part #	Old No.	Interpump Model No.	GP Model No.	GPM	PSI	RPM	Shaft Dia	List Price
8.702-708.0	102202	W905E	T9051E	2.1	1400	1750	5/8"	\$583.74
8.702-710.0	102204	WW906E	TT9061E	2.1	1400	3400	5/8"	\$583.74
8.702-713.0	102210	WW907E	TT9071E	2.8	1500	3400	5/8"	\$580.64
8.702-677.0	102125		TT9111EBF	3.0	1500	1750	5/8"	\$652.05
8.702-679.0	102126		TT2021EBF	2.1	2000	3400	5/8"	\$666.54
8.702-680.0	102127		TT2028EBF	2.8	2000	3400	5/8"	\$641.70
8.702-681.0	102129		TT2035EBF	3.5	2000	3400	3/4"	\$607.55



EZ Series Hollow-Shaft Direct-Drive — flanged for direct couple to gasoline engines



Part #	Old No.	Interpump Model No.	GP Model No.	GPM	PSI	RPM	Shaft Dia	List Price
8.702-764.0	102309	WW961EZG	EZ3040G	4.0	2500	3400	1"	\$825.93
8.702-776.0	102324		EZ4030G34	3.0	4000	3400	1"	\$1,080.54
8.702-778.0	102326		EZ4035G34	3.5	4000	3400	1"	\$942.89
8.702-779.0	102327		EZ4040G34	4.0	4000	3400	1"	\$840.48



EZ Series Hollow-Shaft — flanged for direct couple to electric motors



Part #	Old No.	Interpump Model No.	GP Model No.	GPM	PSI	RPM	Shaft Dia	List Price
8.702-758.0	102301	W956EZE	EZ2536E	3.6	2500	1750	1-1/8"	\$810.41
8.702-759.0	102303	W959EZE	EZ2542E	4.2	2500	1750	1-1/8"	\$795.16
8.702-761.0	102305	W950EZE	EZ2545E	4.5	2500	3400	1-1/8"	\$793.85
8.702-760.0	102304	W953EZE	EZ2555E	5.5	2500	3400	1-1/8"	\$811.44

TX Series Hollow-Shaft Direct-Drive — flanged for direct couple to 184TC electric motor



Part #	Old No.	Model No.	GPM	PSI	RPM	Shaft Dia	List Price
8.702-784.0	102335	TX1810E179	3.2	2000	1750	1-1/8"	\$722.43
8.702-785.0	102336	TX1812E179	3.8	2000	1750	1-1/8"	\$725.54



Interpump / General Pump Kit Selection Chart

Use this selection chart to find the correct repair kit for the specific Interpump / General Pump model.

Pump Model	Valves	Oil Seal Piston	Packings	Packing w/Brass	Ceramic	Valve Caps	Piston Bolts	Head Rings	Crank Oil Seal
TX1510S34	Kit 123	Kit 159	Kit 160	Kit 166	104800	Kit 124	-	-	-
TX1810E179	Kit 123	Kit 159	Kit 161	Kit 167	104804	Kit 124	-	-	-
TX1812E179	Kit 123	Kit 159	Kit 161	Kit 167	104804	Kit 124	-	-	-
TSF2021	Kit 169	Kit 2	Kit 170	Kit 171	083900	-	-	-	Kit 3
TSF2221	Kit 169	Kit 2	Kit 172	Kit 173	107921	-	-	-	Kit 3
TSF2421	Kit 169	Kit 2	Kit 181	Kit 182	107923	-	-	-	Kit 3
T9721	Kit 1	Kit 23	Kit 19	Kit 27	104809	Kit 4	Kit 6	Kit 21	104641
T9731	Kit 1	Kit 23	Kit 19	Kit 27	104809	Kit 4	Kit 6	Kit 21	104637
T731	Kit 1	Kit 23	Kit 19	Kit 27	104809	Kit 4	Kit 6	Kit 21	104641
T991	Kit 1	Kit 23	Kit 19	Kit 27	104809	Kit 4	Kit 6	Kit 21	104641
T9951	Kit 1	Kit 23	Kit 19	Kit 27	104809	Kit 4	Kit 6	Kit 21	104641
T9971	Kit 1	Kit 23	Kit 19	Kit 27	104809	Kit 4	Kit 6	Kit 21	104641
T921	Kit 1	Kit 2	Kit 148	Kit 29	104805	Kit 4	Kit 6	Kit 11	Kit 3
T1011	Kit 1	Kit 2	Kit 69	Kit 28	104803	Kit 4	Kit 6	Kit 7	Kit 3
T1321	Kit 1	Kit 2	Kit 148	Kit 29	104805	Kit 4	Kit 6	Kit 11	Kit 3
T9211	Kit 1	Kit 2	Kit 69	Kit 28	104803	Kit 5	Kit 6	Kit 7	Kit 3
T9281	Kit 1	Kit 2	Kit 109	Kit 112	104808	Kit 106	Kit 107	Kit 108	Kit 3
T4251	Kit 122	Kit 44	Kit 77	Kit 78	104810	-	-	Kit 7	Kit 32
T5050	Kit 150	Kit 2	Kit 109	Kit 151	104808	-	-	Kit 108	Kit 3
TS1021	Kit 1	Kit 2	Kit 69	Kit 28	104803	Kit 4	Kit 6	Kit 7	Kit 3
TS1011	Kit 1	Kit 2	Kit 69	Kit 28	104803	Kit 4	Kit 6	Kit 7	Kit 3
TS1041	Kit 62	Kit 37	Kit 69	Kit 82	104803	-	Kit 54	Kit 7	Kit 32
TS1321	Kit 1	Kit 2	Kit 148	Kit 29	104805	Kit 4	Kit 6	Kit 11	Kit 3
TS1511	Kit 1	Kit 2	Kit 69	Kit 28	104803	Kit 4	Kit 6	Kit 7	Kit 3
TS1531	Kit 62	Kit 37	Kit 69	Kit 82	104803	-	Kit 54	Kit 7	Kit 32
TS2011	Kit 1	Kit 2	Kit 69	Kit 28	104803	Kit 5	Kit 6	Kit 7	Kit 3
TS2021	Kit 1	Kit 2	Kit 69	Kit 28	104803	Kit 5	Kit 6	Kit 7	Kit 3
TT9111	Kit 1	Kit 83	Kit 141	Kit 140	104806	Kit 84	-	-	104641
TT941	Kit 1	Kit 83	Kit 97	Kit 96	083807	Kit 84	-	-	104641
TT9441	Kit 1	Kit 23	Kit 88	Kit 92	104800	Kit 4	-	-	104641
TT2028	Kit 1	Kit 83	Kit 97	Kit 96	083807	Kit 84	-	-	104637
TT2035	Kit 1	Kit 83	Kit 97	Kit 96	083807	Kit 84	-	-	104637
TT9061	Kit 1	Kit 83	Kit 97	Kit 96	083807	Kit 84	-	-	104637
TT9071	Kit 1	Kit 83	Kit 97	Kit 96	083807	Kit 84	-	-	104637
EZ2542E	Kit 123	Kit 23	Kit 127	Kit 131	104804	Kit 124	-	Kit 129	104649
EZ2545E	Kit 123	Kit 23	Kit 88	Kit 130	104800	Kit 124	-	Kit 90	104649
EZ3035G	Kit 123	Kit 23	Kit 88	Kit 130	104800	Kit 124	-	Kit 90	104649
EZ3040G	Kit 123	Kit 23	Kit 88	Kit 130	104800	Kit 124	-	Kit 90	104649
EZ3040S	Kit 123	Kit 23	Kit 88	Kit 130	104800	Kit 124	-	Kit 90	104644
T9051EBF	Kit 1	Kit 83	Kit 97	Kit 96	104800	Kit 84	-	-	104644
EZ2542S	Kit 123	Kit 23	Kit 127	Kit 131	104804	Kit 124	-	Kit 129	104644
EZ3042S	Kit 123	Kit 23	Kit 127	Kit 131	104804	Kit 124	-	Kit 129	104644
EZ4040S34	Kit 123	Kit 23	Kit 153	Kit 156	104812	Kit 124	-	Kit 155	104644
EZ3030G34	Kit 123	Kit 23	Kit 88	Kit 130	104800	Kit 124	-	Kit 90	104649
EZ3045G	Kit 123	Kit 23	Kit 88	Kit 130	104800	Kit 124	-	Kit 90	104649
EZ4035G34	Kit 123	Kit 23	Kit 153	Kit 156	104812	Kit 124	-	Kit 155	104649
TS1331-B	Kit 1	Kit 2	Kit 69	Kit 28	104803	Kit 4	Kit 6	Kit 7	Kit 3
T1631	Kit 1	Kit 24	Kit 148	Kit 28	104805	Kit 4	Kit 6	Kit 11	-
CW1012	Kit 62	Kit 37	Kit 113	Kit 67	104813	-	Kit 74	Kit 65	Kit 32

Genuine Interpump / General Pump Kits

We stock a complete selection of original Interpump / General Pump repair kits. See previous page for our kit selection chart.

- Complete selection of repair kits
- See page 75 for our AR version of these kits for a lower cost alternative.



Part #	Old No.	Kit No.	List Price	Part #	Old No.	Kit No.	List Price	Part #	Old No.	Kit No.	List Price
8.702-798.0	103001G	Kit1, Valve	\$68.91	8.702-849.0	103060B	Kit60, K5 Complete Reblid	\$144.90	8.702-901.0	103110B	Kit110, 16mm Intermed. Ring	\$104.54
8.702-800.0	103002B	Kit2, Piston Rod Oil Seal	\$17.08	8.702-850.0	103061B	Kit61, K3 Complete Reblid	\$162.50	8.702-902.0	103111B	Kit111, Packing Retainer, 16mm Pump T9281	\$95.06
8.702-801.0	103003B	Kit3, Crankshaft Oil Seal	\$24.58	8.702-851.0	103062B	Kit62, Valve	\$213.21	8.702-903.0	103112B	Kit112, 16mm Packing Assy	\$131.45
8.702-802.0	103004B	Kit4, Valve Cap	\$115.92	8.702-852.0	103063B	Kit63 30mm Packing	\$138.69	8.702-904.0	103113B	Kit113, Packing Assy	\$190.44
8.702-803.0	103005B	Kit5, Valve Cap	\$190.44	8.702-853.0	103064B	Kit64, Packing with Intermed. Rings	\$138.92	8.702-908.0	103118B	Kit118, Packing	\$22.56
8.702-805.0	103006B	Kit6, Piston Bolt	\$41.66	8.702-854.0	103065B	Kit65 30MM Head Ring	\$21.74	8.702-909.0	103119B	Kit119, Packing	\$21.06
8.702-806.0	103007B	Kit7, Head Ring	\$18.99	8.702-855.0	103066B	Kit66 Packing Spacer	\$153.18	8.702-910.0	103120B	Kit120, Unloader	\$50.34
8.702-116.0	103008B	Kit8HP old style 20mm Packing	\$53.46	8.702-856.0	103067B	Kit67, 30mm Packing Assy	\$144.90	8.702-912.0	103122B	Kit122, Valves	\$500.94
8.702-115.0	1-0008 103008LP	Kit8, new style Packing Kit	\$74.78	8.702-857.0	103069NB	Kit69, 20mm Packing w/Restop	\$104.52	8.702-913.0	103123B	Kit123, Valve EZ3040	\$83.54
8.900-444.0	103009X	Kit9 Packing Spacer	\$46.32	8.702-858.0	103070B	Kit70, K7 Maint.	\$136.24	8.702-914.0	103124B	Kit124, Valve Cap and O-Ring for EZ Pump	\$116.96
8.702-809.0	103010B	Kit10, Retainer 20mm Packing	\$33.69	8.702-859.0	103071B	Kit71, Intermed. Ring w/Restop	\$104.54	8.702-915.0	103125B	Kit125, EZ Pump	\$58.94
8.702-810.0	103011B	Kit11, 22mm Head Ring	\$16.72	8.702-860.0	103072B	Kit72, Maint. Kit	\$52.26	8.702-917.0	103127B	Kit127, Packing EZ2542S	\$111.78
8.702-811.0	103012B	Kit12, 22mm Packing	\$87.41	8.702-861.0	103074B	Kit74, Piston Bolt	\$160.43	8.702-919.0	103129B	Kit129, Head Ring EZ Series	\$12.29
8.702-812.0	103014B	Kit14, Retainer 22mm Packing	\$31.15	8.702-864.0	103077B	Kit77, 20mm Packing w/Restop	\$146.97	8.702-920.0	103130B	Kit 130 Packing Complete	\$67.17
8.702-813.0	103015B	Kit15 Packing Adapter	\$13.66	8.900-484.0	103080B	Kit80, 45mm Packing Assy	\$157.32	8.702-921.0	103131B	Kit131, EZ Pump	\$83.63
8.702-814.0	103016B	Kit16, 24mm Packing	\$117.99	8.702-870.0	103081B	Kit81 Intermed. Ring	\$181.13	8.702-923.0	103134B	Kit134 Valve TH Pump	\$47.30
8.702-815.0	103017B	Kit17, 24mm Intermed. Ring	\$99.20	8.702-872.0	103083B	Kit83, Oil Seal	\$28.81	8.702-928.0	103140B	Kit140, Packing Assembly, T9111	\$37.42
8.702-816.0	103018B	Kit18 Packing Retainer	\$59.56	8.702-873.0	103084B	Kit84, Valve Cap	\$96.26	8.702-929.0	103141B	Kit141, General	\$56.98
8.702-817.0	103019B	Kit19, 20mm HP Packing	\$65.35	8.702-874.0	103085B	Kit85 Complete Packing	\$28.05	8.702-930.0	103148B	Kit148 22mm Packing	\$120.06
8.702-818.0	103019NB	Kit19 new style	\$67.69	8.702-875.0	103086B	Kit86 Packing Retainer	\$38.81	8.702-931.0	103149B	Kit149, Ring Intermediate	\$64.48
8.702-820.0	103020B	Kit20, 20mm Intermed. Ring	\$32.03	8.702-876.0	103087B	Kit87, Packing	\$35.84	8.702-932.0	103150B	Kit150, Valve General T5050	\$342.59
8.702-821.0	103021B	Kit21, 20mm Head Ring	\$14.65	8.702-877.0	103088NB	Kit88, Packing EZ3040G	\$82.49	8.702-933.0	103151B	Kit151 Packing Retainer	\$140.76
8.702-822.0	103022B	Kit22, 20mm Packing Retainer	\$39.38	8.702-878.0	103089B	Kit89 Intermed. Ring	\$52.06	8.702-934.0	103153B	Kit153, Packing Kit	\$150.08
8.702-823.0	103023B	Kit23, Piston Rod Oil Seal	\$28.72	8.702-879.0	103090B	Kit90, Head Ring	\$9.52	8.702-936.0	103156B	Kit156 13mm Packing	\$139.73
8.702-824.0	103024B	Kit24, Piston Rod Oil Seal	\$32.14	8.702-880.0	103091B	Kit91 Packing Retainer	\$57.08	8.702-937.0	103159B	Kit159 Oil Seal	\$31.39
8.702-825.0	103026B	Kit26, Piston Bolt	\$34.05	8.702-882.0	103092NB	Kit92, Piston Seal	\$68.98	8.702-938.0	103160B	Kit160 Short Packing	\$148.01
8.702-826.0	103027B	Kit27, 20mm Packing Assy	\$41.66	8.702-883.0	103093B	Kit93 Control Set W2	\$57.60	8.702-939.0	103161B	Kit161 Packings	\$147.65
8.702-829.0	103028NB	Kit28, 20mm Packing Assy	\$48.00	8.702-884.0	103094B	Kit94, Control Set	\$13.31	8.702-940.0	103162B	Kit162 Packings	\$181.13
8.702-830.0	103029NB	Kit29, 22mm Packing Assy	\$59.41	8.702-885.0	103095B	Kit95, KR Unloader	\$107.12	9.841-673.0	103163B	Kit163 Seal Retainer	\$59.93
8.702-833.0	103032B	Kit32, Crankshaft Oil Seal	\$31.93	8.702-886.0	103096B	Kit96 Packing Assy	\$21.48	8.702-941.0	103164B	Kit164 Int Ring	\$64.17
8.702-834.0	103037B	Kit37, Piston Rod Oil Seal	\$39.02	8.702-887.0	103097B	Kit97, Packing	\$30.79	9.841-638.0	103165B	Kit165 Int Ring	\$65.36
8.702-836.0	103038NB	Kit38, 36mm Packing	\$138.69	8.702-888.0	103098B	Kit98, ZKW1 Maint.	\$204.93	8.702-942.0	103166B	Kit166 Long Kit1	\$93.99
8.702-838.0	103041B	Kit41 Packing Adapter	\$59.93	8.702-961.0	103220B	Kit100, Hot Kit 190° Water (Replaces Kits #1 and #28)	\$429.53	8.702-943.0	103167B	Kit167 Packing Assy	\$96.88
8.702-840.0	103044B	Kit44, Piston Rod Oil Seal	\$51.39	8.702-893.0	103102B	Kit102 Unloader Maint.	\$151.84	8.702-945.0	103169B	Kit169 Valve Kit	\$244.11
8.702-843.0	103050B	Kit50, Valve Kit	\$45.28	8.702-896.0	103105B	Kit105, P10 Maint.	\$98.64	8.702-946.0	103170B	Kit170LP Seal Kit and HP Seal	\$157.59
8.702-844.0	103051B	Kit51, Timax Maintenance	\$90.86	8.702-897.0	103106B	Kit106, Valve Cap	\$208.04	8.702-947.0	103171B	Kit171 Packings	\$129.38
8.702-847.0	103058B	Kit58, K5 Maint.	\$96.20	8.702-898.0	103107B	Kit107, Piston Bolt Pump T9281	\$77.73	8.702-948.0	103172B	Kit172 Low/High Packing	\$158.36
				8.702-899.0	103108B	Kit108, Head Ring for T-9281	\$13.17	8.702-949.0	103173B	Kit173 Packings	\$129.38
				8.702-900.0	103109NB	Kit109, 16 mm Packing New	\$156.94	8.702-954.0	103181B	Kit181 LP Seal Kit and HP Seal	\$175.95
								8.702-955.0	103182B	Kit182 Packings	\$191.48
								8.702-958.0	103201B	Kit201 Valve Kit	\$189.41

Legacy Pump

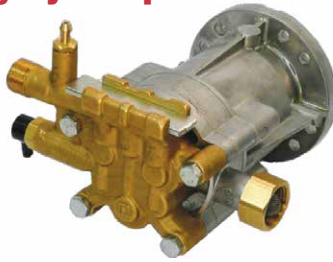

Part #	Shaft	GPM	PSI	RPM	List Price
8.920-004.0	3/4"	2.6	3000	3400	\$213.21

NOTE: Can be used to replace Comet pumps listed on page 75.

AR Triplex Ceramic Plunger Pumps



8.702-585.0

Direct-Drive Gas Engine Flanged Models

Part #	Old No.	Model No.	GPM	PSI	RPM	Shaft Dia	Weight (lbs)	List Price
8.702-552.0	101804	XTV3G16D-F7	3.0	1600	3400	3/4"	10	\$619.97
8.702-494.0	101701	XTV3G22D-F7	3.0	2200	3400	3/4"	11	\$644.81
8.702-501.0	101718	XMV25G26D-F25	2.5	2600	3400	3/4"	19	\$580.64
8.702-498.0	101711	XMV3G30D-F24	3.0	3000	3400	1"	19	\$604.44
8.702-495.0	101702	XMV3G25D-F25	3.0	2500	3400	3/4"	19	\$592.02
8.702-546.0	101796	XMV35G25D-F24	3.5	2500	3400	1"	19	\$743.13
8.702-542.0	101792	XMV35G25D-F25	3.5	2500	3400	3/4"	19	\$614.79
8.702-547.0	101797	XMV4G30D-F24	3.8	3000	3400	1"	19	\$649.98
8.702-585.0	101865	RKV35G30AD-F24	3.5	3000	3400	1"	21	\$809.37
8.702-586.0	101866	RKV4G30AD-F24	4.0	3000	3400	1"	21	\$850.77
8.702-587.0	101867	RKV4G32D-F24	4.0	3200	3400	1"	21	\$902.52
8.702-588.0	101868	RKV4G35HD-F24	4.0	3500	3400	1"	21	\$893.21



8.702-513.0

Solid-Shaft Models

Part #	Old No.	Model No.	GPM	PSI	RPM	Shaft Dia	Weight (lbs)	List Price
8.702-506.0	101731	XTA3G22N	3.0	2200	1750	24mm	11	\$612.72
8.702-507.0	101734	XTA3G19N	3.0	1900	1750	24mm	11	\$651.02
8.715-307.0	101780	XMA3.5G25N	3.5	2500	1750	24mm	18	\$693.45
8.702-590.0	101870	RKA4G20N	4.0	2000	1750	24mm	19	\$849.74
8.702-593.0	101873	RKA4G30N	4.0	3000	1750	24mm	19	\$803.16
8.702-597.0	101877	RKA4G40HN	4.0	4000	1750	24mm	21	\$845.60
8.702-520.0	101765	XW2128N	5.5	4060	1450	24mm	34	\$1,295.82
8.702-513.0	101750	XW2623	6.87	3400	1450	24mm	34	\$1,380.69



8.702-504.0

Direct-Drive Electric Flanged Models

Part #	Old No.	Model No.	GPM	PSI	RPM	Shaft Dia	Weight (lbs)	List Price
8.702-504.0	101730	XTA2G15E	2.1	1500	1750	5/8"	9	\$616.86
8.702-550.0	101801	XTV2G15EBA-F8	2.1	1500	3400	5/8"	10	\$598.23
8.702-551.0	101803	XTV3G16E-F8	3.0	1600	3400	5/8"	10	\$619.97
8.702-508.0	101737	XTV3G20E-F8	3.0	2000	3400	5/8"	11	\$663.44
8.702-500.0	101717	XTV3G22E-F8	3.0	2200	3400	5/8"	11	\$726.57
8.702-515.0	101756	XTA3G22E-F8	3.0	2200	1750	5/8"	11	\$658.26
8.702-514.0	101755	XTA3G16EBA-F8	3.0	1600	1750	5/8"	10	\$652.05
8.702-591.0	101871	RKA4G20E-F17	4.0	2000	1750	1-1/8"	21	\$902.52
8.702-592.0	101872	RKA4G30E-F17	4.0	3000	1750	1-1/8"	21	\$881.68

AR Pump Repair Kit Selection Chart

Use the following chart to find AR Repair Kits by pump model number. See next page for AR kit pricing.

We also stock a broad selection of non-kit AR repair parts.

Pump Model	Water Seals	Check Valves	Oil Seals	Piston Kit	Piston Guide	Support Rings	Hot Kit
XJV	AR002798	AR001864	AR002797	AR002796	AR1980180 ea	AR1980190 ea	NA
XJW	AR002800	AR001864	AR002797	AR002796	AR1980180 ea	AR1980190 ea	NA
XT-15MM	AR001866	AR001864	AR001872-N ver	AR002628	AR1260151 ea	AR1520120 ea	AR002029-V AR002725-H/D
XT-18MM	AR001874	AR001864	AR001872-N ver	AR002629	AR1260450 ea	AR1320340 ea	AR002030-V AR002726-H/D
XTA-15MM	AR001866	AR001864	AR001860-E ver	AR002628	AR1260151 ea	AR1520120 ea	AR002029-V
XTA-18MM	AR001874	AR001864	AR001860-E ver	AR002629	AR1260450 ea	AR1320340 ea	AR002030-V
XTV	AR001866	AR001864	AR001860-D, E ver AR001872-N ver	AR002628	AR1260151 ea	AR1520120 ea	AR002029-V AR002725-H/D
XM-15MM	AR002741	AR001864	AR002786-N ver	AR002544	AR1780090 ea F	AR002740 AR1780100 ea R	AR002776
XM-18MM	AR002747	AR001864	AR002786-N ver	AR002545	AR1780110 ea F	AR002745 AR1780120 ea R	AR002777
XMA-15MM	AR002741	AR001864	AR002786-N ver	AR002544	AR1780090 ea F	AR002740 AR1780100 ea R	AR002776
XMA-18MM	AR002747	AR001864	AR002786-N ver	AR002545 AR002787-E ver	AR1780110 ea F	AR002745 AR1780120 ea R	AR002777
	XMV	AR002741	AR001864	AR002786-N ver	AR002544 AR002787-D ver	AR1780090 ea F	AR002740 AR1780100 ea R
AR002776							
XRC-18MM	AR001857	AR001828	AR001855- N ver	AR002546	AR1380090 ea	AR001829	AR002809
XRC-20MM	AR001887	AR001828	AR001855- N ver	AR002547	AR1380150 ea	AR001815	AR002810
XRCA-18MM	AR001857	AR001828	AR001855- N ver	AR002546 AR001856-E ver	AR1380090 ea	AR001829	AR002809
XRCA-20MM	AR001887	AR001828	AR001855- N ver	AR002547 AR001856-E ver	AR1380150 ea	AR001815	AR002810
XRCV	AR001857	AR001828	AR001856-D, E ver	AR002546	AR1380090 ea	AR001829	AR002809
RK-18MM	AR001857	AR002864	AR001855-N ver	AR002546	AR1380090 ea	AR001829	AR002809
RK-20MM	AR001887	AR002864	AR001855-N ver	AR002547	AR1380150 ea	AR001815	AR002810
RKA-18MM	AR001857	AR002864	AR001855-N ver	AR002546	AR1380090 ea	AR001829	AR002809
RKA-20MM	AR001887	AR002864	AR001855-N ver	AR002547	AR1380150 ea	AR001815	AR002810
RKV	AR001857	AR001828	AR001856	AR002546	AR1380090 ea	AR001829	AR002809
XW-20MM	AR002782	AR002780	AR002781	AR002650	AR002784	NA	AR002778
XW-22MM	AR002783	AR002780	AR002781	AR001891	AR002785	NA	AR002779
XWA-20MM	AR002782	AR002780	AR002781	AR002650	AR002784	NA	AR002778
XWA-22MM	AR002783	AR002780	AR002781	AR001891	AR002785	NA	AR002779
SXW-18MM	AR002874	AR002871	AR002873	AR002548	AR002875	NA	NA



AR Pump Kits

Original factory-direct repair kits. See previous page for kit selection chart. Don't see what you're looking for? Give us a call. We stock a broad selection of AR replacement parts. AR piston kits contain all that you need to repair broken pistons, O-rings, washers, nuts, plungers...YOU GET IT ALL!



Part #	Old No.	Kit Description	List Price	Part #	Old No.	Kit Description	List Price
8.720-573.0	AR001804	Packing	\$138.69	8.720-606.0	AR001887	Water Seals	\$129.38
8.720-574.0	AR001805	Packing, 20mm	\$170.78	8.720-611.0	AR002031	Viton Seal, XRA	\$369.50
8.740-118.0	AR001806	Pump	\$138.69	8.720-612.0	AR002043	Oil Seal	\$42.23
8.720-575.0	AR001815	Piston	\$10.51	8.720-613.0	AR002044	Seal	\$57.55
8.720-578.0	AR001825	Valve Kit	\$70.48	8.720-632.0	AR002544	Piston, XM*	\$156.29
8.720-579.0	AR001826	Piston Bolt	\$123.17	8.720-633.0	AR002546	Piston XRCA / XRCV	\$197.76
8.720-581.0	AR001828	Valve	\$53.92	8.720-643.0	AR002624	Seal	\$111.78
8.720-582.0	AR001829	Ring, Support XRA / XRV*	\$14.80	8.720-644.0	AR002628	AR Piston #2628	\$153.18
8.720-583.0	AR001830	Repair, AR 2882 O-Rings Only	\$15.84	8.720-649.0	AR002697	Repair, Combi-Set	\$26.03
8.720-585.0	AR001842	Piston, XRA / XRV*	\$232.88	8.720-651.0	AR002740	Support Ring, XM*	\$5.12
8.720-586.0	AR001843	Piston, XRA, XR	\$279.45	8.720-652.0	AR002741	Water Seal, XM*	\$86.42
8.720-592.0	AR001855	Oil Seal, XRA*	\$63.08	8.720-655.0	AR002747	Packing XMA* 18MM	\$110.75
8.720-593.0	AR001856	Oil Seal, XRV	\$66.24	8.720-658.0	AR002776	Hot / Dry Cup	\$330.17
8.720-594.0	AR001857	Packing XRA / XRV*	\$124.63	8.720-661.0	AR002780	Valve XWA8G30N-SX	\$123.17
8.720-596.0	AR001860	Seal, Oil, XTV*	\$45.28	8.720-662.0	AR002781	Seal XWA8G30N-SX	\$66.81
8.720-597.0	AR001864	Valve Kit	\$45.85	8.720-663.0	AR002782	Piston Seal, XWA8G30N-SX	\$125.24
8.720-598.0	AR001865	Oil Seal	\$45.70	8.720-665.0	AR002784	Piston Guide, XWA8G30N-SX	\$112.82
8.720-599.0	AR001866	Water Seals	\$83.47	8.720-667.0	AR002786	Oil Seals XMA35G25N	\$40.42
8.720-601.0	AR001869	Repair Unloader	\$30.33	8.720-668.0	AR002787	Oil Seals	\$53.92
8.720-602.0	AR001872	Oil Seal	\$42.07	8.720-684.0	AR002864	Valve Kit, RK*	\$65.62
8.720-603.0	AR001873	Oil Seal Kit Cmplt	\$50.51				
8.720-604.0	AR001874	Packing	\$87.82				

*Series

*Series

Comet Pumps and Pump Kits



For use in homeowner or light commercial-duty pressure washer.

- One-piece bronze connection rods
- Built-in unloader
- Increased surface area for lower operating temperatures
- Ultra high-pressure head

Part #	Old No.	Model No.	GPM	PSI	RPM	Shaft Dia	List Price
9.802-357.0	5-2107	AXD 2020 E	1.9	2000	3400	3/4"	\$551.66
8.702-576.0	101850	AXD 3020 G	2.75	2000	3400	3/4"	\$497.84
8.715-286.0	830160	AXD 2427 G	2.5	2700	3400	3/4"	\$520.61
8.750-238.0		BXD 2020 E	1.9	2000	3400	3/4"	\$419.18

Comet kits and parts are available for any Comet model. Call with model number for quick and accurate service.



Part #	Old No.	Model No.	List Price
8.721-902.0	CT0202002000	Piston 15MM FWD	\$54.91
8.721-903.0	CT0202002200	Piston 18MM FWD	\$70.02
8.718-556.0	CT5019003500	Seal Kit LWD HP	\$77.83
8.721-979.0	CT5019003800	Packing Kit FWS / FWD	\$146.97
8.721-985.0	CT5019004500	Seal Kit Oil LW Series Hollow	\$58.43
8.721-986.0	CT5019006400	Seal Kit ZWD4030G	\$85.91
8.721-987.0	CT5019006500	Seal Kit Hollow Shaft Pumps	\$47.63
8.721-989.0	CT5019007800	Seal Kit AXD2020	\$106.61
8.721-988.0	CT5019007700	Seal Kit AXD3020	\$79.07
8.750-711.0		Seal Kit BXD2020 E	\$119.03
8.721-996.0	CT5025001100	Valve Kit ZWD / FWS / FWD / HW / FW / LW	\$84.33
8.721-997.0	CT5025001400	Valve Kit AXD 3020	\$56.72
8.725-562.0		Valve Kit BXD2020	\$128.34

Ceramic Plungers

Precision-ground, high-polish, solid ceramic plungers, designed for long life even under constant use.



Part #	Old No.	General Pump Part #	Size	List Price
8.703-185.0	104798	51040109	18mm	\$74.99
8.703-187.0	104800	52040009	15mm, EZ Series	\$70.35
8.703-188.0	104801	46040009	For W50 Pump	\$143.87
8.703-190.0	104803	47040409	20mm	\$62.47
8.703-191.0	104804	44040109	18mm, EZ Series	\$74.11
8.703-192.0	104805	47040509	22mm	\$78.30
8.900-575.0	104806	51040166	18mm, TP Series	\$70.54
8.703-193.0	104807	47040609	24mm Solid, Ceramic	\$110.75
8.703-194.0	104808	47040856	16mm, 47 Series	\$130.41
8.703-195.0	104809	50040409	20mm, T Series 49	\$78.71
8.703-196.0	104810	61040056	20mm, 76 and 77 Series	\$712.08
8.703-197.0	104811	69040009	36mm	\$222.53
8.703-198.0	104812	44040266	13mm, EZ Series	\$149.04
8.703-199.0	104813	69040109	30mm	\$375.71
8.703-200.0	104815	76040209	45mm	\$256.68
8.703-767.0	107921	66040109	22mm, TSF2221	\$143.87
8.703-768.0	107923	66040409	24mm	\$124.20
8.701-400.0			15mm, T21	\$55.45

Packing and Seal Kits

UPC, General Pump and Interpump replacement kits. Time-tested, quality parts meet or exceed factory specifications.



Part #	Old No.	Description	List Price
8.900-438.0	103001X	Kit 1, Check Valve	\$47.33
8.900-440.0	103002X	Kit 2, Oil Seal	\$14.54
8.900-441.0	103003X	Kit 3, Crankshaft Oil Seal	\$31.83
8.900-442.0	103008LPX	Kit 8, New Style packing Kit	\$82.44
8.900-443.0*	103008X	Kit 8, V-Packing	\$60.24
8.900-444.0*	103009X	Kit 9, Intermed Packing	\$46.32
8.900-447.0*	103012X	Kit 12, V-Packing	\$87.15
8.900-456.0*	103019X	Kit 19, V-Packing	\$66.81
8.900-463.0	103023X	Kit 23, Crankcase Oil Seal	\$39.17
8.900-464.0	103024X	Kit 24, Crankcase Oil Seal	\$25.62
8.900-466.0*	103027X	Kit 27, Plunger Repair	\$42.44
8.900-468.0*	103028X	Kit 28, Plunger Repair	\$38.50
8.900-471.0*	103029X	Kit 29, Plunger Repair	\$54.60
8.900-476.0	103037X	Kit 37, Oil Seal	\$36.07
8.900-485.0	103083X	Kit 83, Oil Seal	\$19.98
8.900-488.0	103087X	Kit 87, V-Packing	\$32.24
8.900-492.0	103097X	Kit 97, Packing	\$30.43

*These are old style kits to replace components in Interpump / General pumps with two brown Buna-V packings (pumps built before the change was made to restop ring and black low-pressure seals.)

Piston Pumps



8.702-156.0

- Cast-iron body
- Stainless-steel check valves
- Complete with base or torque arm
- Buna cups
- 140° max temperature except 5321
- 180° max temperature 5321
- 1/2 NPT ports

Part #	Old No.	Hypro	GPM	PSI	RPM	List Price
Solid Shaft						
8.702-155.0	100314	5315	1.5	500	1750	\$555.80
8.702-158.0	100319	5320	2.0	500	1750	\$596.16
8.702-161.0	100322	5321	2.2	1000	1750	\$623.88
8.702-163.0	100325	5324	2.9	800	1750	\$1,050.53
8.702-167.0	100331	5330	3.0	500	1750	\$570.71
Hollow Shaft						
8.702-156.0	100315	5315	1.5	500	1750	\$668.61
8.702-157.0*	100316	5315	1.5	500	1750	\$616.35
8.702-159.0	100320	5320	2.0	500	1750	\$597.20
8.702-160.0	100321	5321	2.2	1000	1750	\$612.72
8.702-162.0	100324	5324	2.9	800	1750	\$627.21
8.702-164.0	100326	5325	2.5	500	1750	\$596.16
8.702-166.0	100330	5330	3.0	500	1750	\$582.40
8.702-146.0	100301	Injector Head 5320 / 5330 Pump				\$184.23
8.702-152.0	100306	Injector Head 5321 / 5324 Pump				\$165.02

*Has Teflon seals

Pump Parts and Tools



For 5300 series pump.



Piston Repair Kit Valve Seat Tools Valve Cage Tools

- A necessity for working on 5300 series pumps
- Rugged construction

Part #	Old No.	Description	List Price
8.722-629.0	H34300010	Piston Repair Kit (Model 5320 pump)	\$37.00
8.722-634.0	H34300144	Piston Repair Kit (Model 5321 pump)	\$60.19
8.722-641.0	H34300197	Check Valve Kit (All 5300 Pumps)	\$55.20
8.712-510.0	449052	Valve Cage Tool	\$100.03
8.712-512.0	449071	Valve Seat Tool	\$432.63

NOTE: Piston Repair Kits have Buna seal

Jetter Pulse Valves



Replaces valve cap to create pulsation action, to move nozzle in pipe cleaning applications.

Part #	Old No.	Description	List Price
8.755-228.0		For Legacy GB/GF/GP Series	CALL
8.755-229.0		For Legacy GM Series	CALL
8.755-230.0		For Legacy GT Series	CALL
8.755-231.0		For Legacy GX Series, 4350 PSI	CALL
8.755-232.0		For Legacy GX Series, 3000 PSI	CALL
8.712-249.0	410317	For GP 47 Series Pumps	\$113.85
8.712-250.0	410318	For GP TT Pumps	\$113.85

Accumulator by Interpump



Pulse dampener.



- 3/4" MPT connector
- 10 GPM max flow
- 1350 PSI max pressure
- Weight 1 lb

Part #	Old No.	Description	List Price
8.711-148.0	381110	Accumulator	\$92.79

Accumulator – Pulse Dampener



8.711-145.0

8.711-147.0

- 180°F max temperature
- Precharge pressure 580 PSI

Part #	Old No.	Working PSI	Capacity	Inlet	List Price
8.711-145.0	381102	3100	21.4 CU"	1/2"F	\$89.73
8.711-146.0	381103	3100	6.1 CU"	3/8"F	\$180.64
8.711-147.0	381104	4400	2.5 CU"	3/8"F	\$173.88

Packing Extractor



Virtually unbreakable sockets will pull packings from Interpump, General and other brand pumps.

Easy to use: Slide-Hammer (shown below) attaches to slotted socket—which expands inside the packing gland. The slide hammer then pops the packing gland brass out of the head to facilitate easy seal repairs without damage to brass support rings.

Part #	Old No.	Description	List Price
Slide Hammer			
8.712-513.0	449299	Hammer Only	\$86.11
Sockets for Regular Slide Hammer			
8.712-516.0	449302	18mm Socket	\$46.52
8.712-515.0	449301	15mm Socket	\$46.52
8.712-517.0	449303	20mm Socket	\$45.18
8.712-518.0	449304	22mm Socket	\$45.18
8.712-520.0	449307	25mm Socket	\$44.25
Large Slide Hammer			
8.712-521.0	449309	Large Slide Hammer	\$112.82
Sockets for Large Slide Hammer			
8.712-523.0	449311	30mm Socket	\$156.29
8.712-524.0	449312	38mm Socket	\$207.00
8.712-525.0	449313	45mm Socket	\$388.13

Interpump Packing Extractor Tool



Expansion tool inserts into packing gland to remove lodged packing components.



Part #	Old No.	Description	List Price
8.712-522.0	449310	Extractor (only)	\$371.57
Expansion Sockets for Extractor Above			
8.712-526.0	449315	15mm (Ref Kit 86 and 97)	\$285.66
8.712-528.0	449320	20mm (Ref Kit 8 and 19)	\$216.32
8.712-529.0	449322	22mm (Ref Kit 12)	\$195.62
8.712-530.0	449324	24mm (Ref Kit 16)	\$186.30

NOTE: 15mm Expansion Sockets also fit Admiral Pump W-Series pumps.

O-Ring Tool

Indispensable for Pump Repair.

Excellent for removing O-rings, seals, etc.

- 6" long dental pick
- Stainless-steel
- Knurled handle
- Double-end



Part #	Old No.	Description	List Price
8.707-467.0	249737	Dental Pick	\$10.09
9.802-568.0	959260	Pliers, Seal Extractor	\$72.92

V-Packing Insertion Tool Kit



Contains inserting tools for installing 20mm, 22mm and 24mm V-packings in the packing gland. Prevents damaged sealing surfaces.

Part #	Old No.	Description	List Price
8.712-519.0	449305	V-Packing Kit	\$38.14

Pump Oil



Quality mineral base lubricating oil ideal for use in high pressure piston precision plunger pumps. Blended with wear, rust, and foam inhibitors.

Part #	Description	List Price
8.923-425.0	Pump Oil 10W (quart)	\$10.30

Pump Lube



- A premium-quality lubricating oil fortified with additives to reduce friction, foaming and corrosion
- Excellent for use in Cat Pumps and other fine precision machinery

Part #	Old No.	Description	List Price
8.901-078.0	112056	Pump Lube (quart)	\$13.29
8.901-081.0	112076	Case Lot (qty 12)	\$123.17

"Inter-Lube-Red" Gear Lube



Inter-Lube Red gear lube is a multi-viscosity SAE 80W 90 lubricant with anti-friction, anti-foaming and corrosion-inhibitor additives. Use in Admiral Geared Speed Reducers and Interpump / General RS99, RS151, PTO as well as other high-speed gear boxes.

Part #	Old No.	Description	List Price
8.901-076.0	112052X	Interlube (quart)	\$20.80
8.901-079.0	112072X	Case Lot (qty 12)	\$175.95

Complete Pump Extraction Kit



- 13mm-24mm in a carrying case
- Slide hammer
- 13mm, 15mm, 18mm, 20mm, 22mm and 24mm sockets

Part #	Description	List Price
8.723-619.0	Extraction Kit	\$110.75

Geared Reduction

Specifically designed for Legacy and Admiral pumps.



- Engine-to-pump drive units
- 2.1 to 1 reduction ratio (3,675 Eng. RPM=1,750 Pump RPM)
- Engine shaft size = 1" or 1-1/8"
- Pump shaft size = 24mm or 30mm

Part #	Old No.	Description	List Price
8.710-332.0	349120	24mm Pump x 1" Engine	\$470.93
8.710-333.0	349121	30mm Pump x 1" Engine	\$510.26
8.710-334.0	349122	30mm Pump x 1-1/8" Engine	\$557.87

Geared Reduction

Fits Admiral, Interpump, AR, Comet, Udor, and Hawk.



- Engine-to-pump drive units
- 2.18 to 1 reducer
- For 11-18 HP gasoline engine
- For pumps with a 24mm shaft

Part #	Old No.	Description	List Price
8.710-335.0	349130	1" Engine Shaft	\$383.99
8.710-336.0	349131	1-1/8" Engine Shaft	\$453.33

Anti-Seize Compound

Recommended for all metal-to-metal, power-drive assemblies. Facilitates removal after use.



- Copper-graphite or nickel
- Copper-graphite high-torque for high temperature to 1800°F
- Nickel continues to work up to 2400°F
- Stops rust, galling and seizure on pulley / shaft or gear / shaft interfaces

Part #	Old No.	Description	List Price
8.704-638.0	112299	Blister Pack (1 appl) Copper – Graphite	\$2.28
8.704-641.0	112305	8 oz Brush Top Can – Nickel	\$53.04

Geared Reduction Units Interpump / General



For use with 1,450 RPM Interpump, General Pumps and Admiral A-W99.

RS99 2.4:1 Gear Reduction (3,480 engine RPM = 1,450 RPM Pump)
For 3-5 HP Briggs, Honda-Tecumseh-Kohler with 3/4" shaft

RS151 2.2:1 Gear Reduction (3,190 engine RPM = 1,450 RPM pump)
For 7-18 HP Briggs, Honda engines with 1" or 1-1/8" shaft (must specify) Use with the appropriate size: "WS" series Interpump, "TS" series General pump



8.710-321.0

- Eliminates belts, pulleys and belt guards
- Engine-to-pump drive units
- Improve efficiency

Part #	Old No.	Engine Shaft	List Price
RS-99			
8.710-321.0	349009	3/4"	\$418.14
RS-151			
8.710-322.0	349011	1"	\$576.50
8.710-324.0	349013	1-1/8"	\$482.31



8.710-322.0

PTO Geared Multiplier



- 1 to 1.9 speed multiplier
- 1-3/8" splined shaft (same shaft as standard tractor PTO)
- 540 RPM PTO speed multiplied to 1,026 RPM at pump shaft
- For pumps with a 24mm shaft

Part #	Old No.	Description	List Price
8.710-319.0	349005	Gear Multiplier	\$594.09

Flanges

Direct attachment of Legacy Pumps to NEMA Standard C-Face Motors.



Part #	NEMA Frame	Pump Series	List Price
8.754-098.0	184 TC / 215 TC	GM	\$45.00
8.754-099.0	184 TC / 215 TC	GT-GX	\$45.00

Flex Couplers

Pump shaft couplers. Direct-drive self-adjusting resilient coupling Legacy pumps to NEMA Standard Motor Shafts.



2-Piece Coupler

Part #	NEMA-C Frame	Pump Series	Motor Drive Coupling	List Price
8.754-100.0	184 TC	GM	1-1/8" x 24 mm	\$40.35
8.754-101.0	215 TC	GM	1-3/8" x 24 mm	\$40.35
8.754-102.0	184 TC	GT-GX	1-1/8" x 25 mm	\$40.35
8.754-103.0	215 TC	GT-GX	1-3/8" x 25 mm	\$40.35

Flanges

Direct attachment of Interpump / General Pumps to NEMA Standard C-Face Motors.



Part #	Old No.	NEMA Frame	Pump Frame Size	List Price
8.709-613.0	336020	56 / 145TC	W973	\$43.99
8.709-615.0	336024	184TC*	W995	\$135.59
8.709-616.0	336025	215TC**	W913	\$149.72
8.709-870.0	339120	8-13 HP(G)	WW161	\$107.64

*W995 / GD

**W913 / GM

Flex Couplers

24mm pump shaft couplers. Direct-drive flex coupling 24mm Interpump / General and Admiral XLS Series pumps to NEMA Standard Motor Shafts.



2-Piece Coupler

Part #	Old No.	NEMA Frame	Drive Shaft	List Price
2-Piece Coupler				
8.709-617.0	336028	56 A	5/8"	\$51.85
8.709-619.0	336030	145 T	7/8"	\$50.66
8.709-621.0	336032	184 T	1-1/8"	\$51.18
8.709-624.0	336036	215 T	1-3/8"	\$153.18
8.709-869.0	339112A	Gas (Aluminum)	1"	\$45.85
8.701-262.0	080320	Rubber Bumper – Replacement		\$3.62

Pump Technical Information

Correct pump installation is essential for optimum performance. It is recommended that the pump flow capacity be oversized for the actual flow required. For optimum running of the system, the water circulated through the regulating valve should not exceed 10-15% of the pump flow. Recirculating too much water can generate heat in the supply tank increasing the cavitation risk.

Frequently Asked Questions:

Question: How much should you reduce the pump RPM to achieve a lower flow capacity? **Answer:** Required RPM = Expected Capacity x $\frac{\text{Max RPM Allowed}}{\text{Max Allowed Capacity}}$

Question: What diameter of pulley must I use to achieve the correct pump RPM? **Answer:** $\frac{\text{External Diameter of the Engine}}{\text{Motor Pulley}} = \text{External Diameter of the Pump Pulley} \times \frac{\text{Pump RPM}}{\text{Engine / Motor RPM}}$

Question: What if I cannot change the engine / motor pulley? **Answer:** External Diameter of the Pump Pulley = $\frac{\text{External Diameter Engine}}{\text{Motor Pulley}} \times \frac{\text{Engine / Motor RPM}}{\text{Pump RPM}}$

Question: If the engine / motor is running at a lower RPM than the maximum pump RPM allowed, what will be the pump flow capacity? **Answer:** Attainable Maximum Capacity = Engine / Motor RPM x $\frac{\text{max capacity indicated on the label}}{\text{max RPM indicated on the label}}$

Question: What is the approximate power required to achieve the maximum performances allowed? **Answer:** Required Electric Motor HP $\frac{\text{PSI} \times \text{GPM}}{1460} = \text{Electric Motor HP}$
Required Gas Engine HP $\frac{\text{PSI} \times \text{GPM}}{1460} \times 1.30 = \text{Gas Engine HP}$

Conditions to prevent pump cavitation: Minimum difference in height HZ (pos / neg) between pump and water level.

The minimum inlet pressure value of the pump is limited by the cavitation phenomenon. Cavitation is the forming of vapor bubbles when the local pressure is below the vapor pressure of the liquid. Bubbles flow together with the liquid and when they reach a higher pressure area, they collide, generating abnormal stresses that are extremely dangerous to the pump components. To avoid the risk of cavitation, it is necessary that the pump installation is correct.

Legacy Universal Unloader (UU1)



The Legacy Universal Unloader is unique in that it allows for height or width adjustments making it ideal for any pump.

- 6 GPM
- 3500 PSI
- 195°F
- Forged-brass body
- 1/2" NPT inlet
- 3/8" NPT outlet
- Stainless-steel seat and low-friction, wear-resistant plunger
- 16.1 oz weight
- Patent US 8,313,311 B2

Part #	Description	List Price
9.175-018.0	Legacy Universal Unloader (UU1)	\$123.60

Minimum Adjustment:

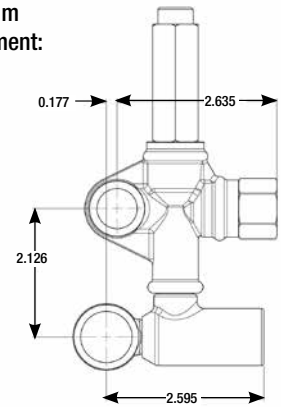

Adjusting inlet port

- 1.- Push up inlet port to make it shorter.
- 2.- Pull down inlet port to make it longer.

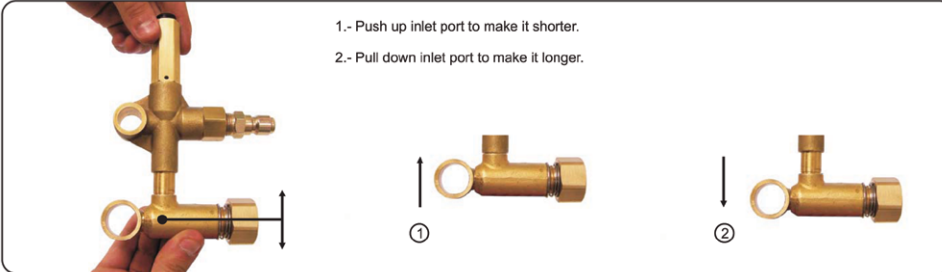

Maximum Adjustment:

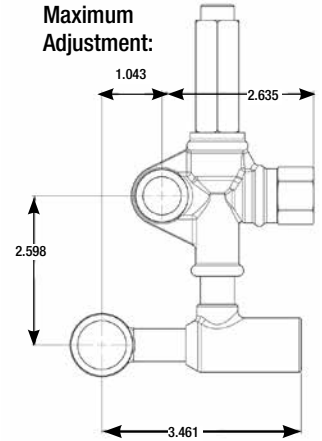

Adjusting horizontal sliding connector

- 1.- Turn the connector clockwise direction to make it shorter.
- 2.- Turn the connector counterclockwise direction to make it longer.

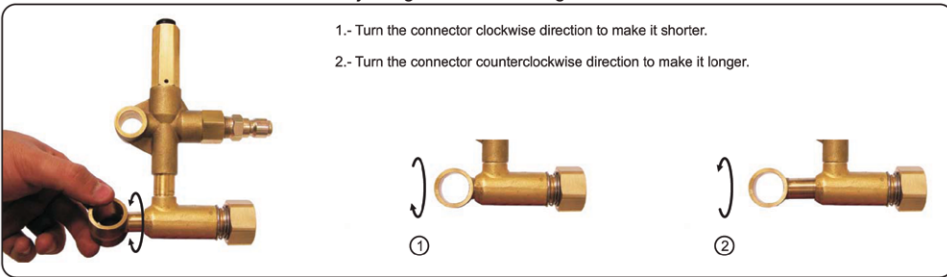

Automatic Pressure Regulator

Integral Regulator for Admiral Pumps: WE - WG - WEL - XLS - XLE - XLG bolt on for Admiral and Legacy Pumps. Trapped-pressure regulator specifically designed for use on the Admiral plunger pumps. Integral inlet, bypass and outlet eliminates the need for bypass hose.



8.703-401.0

- 6 GPM
- 3200 PSI
- 195°F
- Forged-brass body
- 3/8" MPT outlet
- Stainless-steel plunger and seat valve
- 29 oz weight

Part #	Old No.	Description	Inlet	List Price
8.703-401.0	106020	APR-Brass / Black 3/8"		\$104.54
9.802-365.0	106022	APR-Brass / Black 1/2"		\$110.24
8.900-760.0	109139	Seal Repair Kit - 3/8"		\$10.14
8.900-761.0	109139X	Seal Repair Kit - 1/2"		\$11.39
8.900-762.0	109140	Valve Seat Repair Kit		\$23.34

Regulators / Unloaders

Basic valves, premium performance.



- Forged-brass body
- Stainless-steel seat and piston
- 3/8" MPT inlet, outlet and bypass
- 194°F

520 Regulator / Unloader

- Rated @ 2000 PSI
- 13 oz weight
- Tested up to 2400 PSI
- 8 GPM

VR54 Black Regulator / Unloader

- Rated @ 2175 PSI
- 15 oz weight
- Tested up to 2800 PSI
- 8 GPM

VR54 Red Regulator / Unloader

- Rated @ 2900 PSI
- 13.7 oz weight
- Tested up to 2800 PSI
- 8 GPM

VR56 Regulator / Unloader

- Rated @ 3625 PSI
- 15 oz weight
- Tested up to 3400 PSI
- 8 GPM

Repair Kits

- For use with 520 regulator / unloaders

Part #	Old No.	Description	List Price
8.712-589.0	462320K	520 w/ Knob	\$47.06
8.704-003.0	109177	Seal Repair Kit	\$13.71
8.704-004.0	109178	Valve Seat Repair Kit	\$12.32
8.753-028.0		VR54 Black	\$57.10
8.753-029.0		VR54 Red	\$60.79
8.753-017.0		VR56 w/ Knob	\$76.65

Regulator / Unloader VRS3



- 8 GPM
- 3630 PSI
- 194°F
- 3/8" MPT inlet and outlet, 1/4" FPT bypass
- Adjustable pressure setting nut
- Heavy-duty forged-brass body
- Stainless-steel ball and valve seat
- High-temperature Viton seals
- Adjustable upper-pressure limit lock

Part #	Description	List Price
8.753-027.0	w/o Knob	\$68.38
8.753-026.0	w/ Knob	\$80.24

VBA35 / VB55 Unloader Valves for Legacy HD Pumps



- 6.6 GPM
- 3500 PSI



Part #	Description	List Price
VBA35 for Legacy HD models		
9.803-899.0	GG, GD, GE	\$109.18
9.803-900.0	GM, GS	\$126.63

- 8 GPM
- 3650 PSI

Part #	Description	List Price
VB55 for Legacy HD models		
9.802-363.0	GM, GS	\$113.36

VRT3 Unloader Valves



- Forged-brass body
- Stainless internals
- Up to 4500 PSI
- 200°F
- 8 GPM
- 3/8" in-out / bypass

Part #	Description	List Price
8.750-297.0	2320 PSI Yellow	\$78.26
8.750-298.0	3630 PSI Blue	\$81.02
8.750-299.0	4500 PSI Black	\$82.76
8.750-300.0	4500 PSI w/ EZ Start Black	\$98.14
8.750-955.0	4500 PSI w/ Switch, w/o Knob	\$125.66
8.750-956.0	4500 PSI w/ Switch, w/ Knob	\$127.92
8.750-709.0	Repair Kit, VRT3, 2320/3630 PSI	\$28.65
8.750-710.0	Repair Kit, VRT3, 4500 PSI	\$29.59
9.802-694.0	Repair Kit Old Style VRT 605,606,607	\$40.01

VRT100 Unloader Valves



- Forged-brass body
- Stainless internals
- Up to 5075 PSI
- 194°F
- 26.4 GPM
- 1/2" in-out / bypass

Part #	Description	List Price
8.753-726.0	5075 PSI Blue	\$184.00
8.753-443.0	2760 PSI Yellow	\$185.00
8.753-444.0	5075 PSI Blue	\$185.00
8.753-727.0	5075 PSI Blue Microswitch 120/240VAC	\$225.00
8.754-012.0	VRT100 Repair Kit	CALL

Pulsar Unloaders



- Pulsar 4 blue rated 3200 PSI - Max 3650 PSI
- Pulsar 4 white rated 1400 PSI - Max 1750 PSI
- Pulsar 280 HP rated 4050 PSI - Max 4350 PSI
- 195°F
- 8 GPM
- All stainless-steel valves
- Pressure actuated
- Forged body
- 3/8" FPT inlet, outlet
- Two 3/8" FPT bypass ports

Part #	Original No.	Description	List Price
8.712-653.0	462654	Pulsar 4 (White) w/ Knob	\$100.15
8.704-462.0	111100	Repair Kit - Pulsar 4	\$44.41
9.802-004.0	111375	Repair Kit - 280 HP	\$28.10

VB7 Regulator / Unloader



Fits CAT 4SF pumps and other pumps; 7.8 GPM – 3600 PSI max pressure.



- Rated pressure: 3200 PSI
- 200°F
- 3/8" MPT inlet, 1/4" FPT gauge port
- 3/8" FPT outlet and bypass
- 19.7 oz weight

Part #	Old No.	Description	List Price
8.712-741.0	463670	w/o Knob	\$81.22
8.904-580.0	463670K	w/ Knob	\$96.77
8.704-488.0	111175	Repair Kit	\$71.97
8.712-735.0	463600	Knob Only	\$3.98

VB130 Regulator / Unloader



Fits CAT 2SF pumps and other pumps; 6.6 GPM – 2600 PSI max pressure.



- Rated pressure: 2300 PSI
- 200°F
- 3/8" MPT inlet and outlet
- 3/8" FPT bypass
- Stainless-steel plunger
- Stainless-steel valve seat
- 14.7 oz weight

Part #	Old No.	Description	List Price
8.712-739.0	463660	w/o Knob	\$59.64
8.904-579.0	463660K	w/ Knob	\$68.78
9.802-006.0	111150	Repair Kit	\$85.49
8.712-735.0	463600	Knob Only	\$3.98

VB85 / 820 Regulator / Unloader



- VB85 rated @ 4050 PSI
- 200°F
- Pressure actuated
- Forged-brass body
- Stainless-steel plunger and seat
- 1/2" FPT in/out bypass
- 45 oz weight

Part #	Description	List Price
8.751-964.0	VB85/280 – Blue Spr	\$173.04
8.751-963.0	VB85/280 – Blue Spr	\$154.96

VB200 / 150 High-Volume Unloader



- 52.5 GPM
- Forged-bronze body
- Large plastic knob (removable)
- Lock nut on pressure adjustment
- 2175 PSI
- 194°F
- 1" FPT Inlet, outlet and bypass
- Two 5/16" – 18 bolt mounting ports
- 73.5 oz weight

Part #	Old No.	Description	List Price
8.712-754.0	463714	VB 200/150 w/o Knob	\$525.20
8.712-755.0	463715	VB 200/150 w/ Knob	\$542.88
8.704-583.0	111550	Repair Kit	\$94.96

VB75 / VB135



The VB75 is an integrated unloader for Interpump and General pumps with 7.8 GPM – 3600 PSI max pressure. The VB135 fits Interpump "WW" Series Pumps and General "TT" Series Pumps with 6.5 GPM – 2600 PSI max pressure.



VB75



VB135

- VB75
- Rated pressure: 3200 PSI
- 200°F
- 1/2" MPT inlet, 1/4" FPT gauge port
- 3/8" FPT outlet and bypass
- 19.7 oz weight

- VB135
- Rated pressure: 2300 PSI
- 200°F
- 3/8" MPT inlet, 1/4" FPT outlet
- Stainless internals
- Forged-brass body
- 22.9 oz weight

Part #	Old No.	Description	List Price
VB75			
8.712-742.0	463672/462646	Series 44 (EZ) and 47 pumps (W151)	\$126.88
8.704-488.0	111175	Seal Kit	\$71.97
8.712-735.0	463600	Knob Only	\$3.98
8.705-934.0		1/2" Bolt w/ Hole	\$16.74

Part #	Old No.	Description	List Price
VB135			
8.712-659.0	462659	VB 135	\$101.92
8.712-735.0	463600	Knob Only	\$3.98
9.802-006.0	111150	VB 135 Repair Kit	\$85.49
8.705-935.0		3/8" Bolt w/ Hole	\$14.82

VB80 / 400 Stainless-Steel Unloader



- 21 GPM
- Rated 5800 PSI
- Forged stainless-steel body
- 195°F
- All stainless-steel valve parts
- Viton seals
- 1/2" FPT inlet, outlet and bypass

Part #	Old No.	Description	List Price
8.712-656.0	462656	VB 80/400	\$780.00
9.802-007.0	111340	Repair Kit	\$30.48

Automatic Pressure Compensating Unloader Valves VB10 / VB9



VB10



VB9

- 7.8 GPM – 3600 PSI
- Rated 3200 PSI
- 194°F
- Reduces trapped pressure to 25% of operating pressure when unloading; allows easier gun trigger pull
- Instant pressure response
- Hex-shaped non-stick check valve
- 3/8" in/out bypass
- Brass valve body/stainless ball and seat
- Knob included
- VB9 – Panel mountable

Part #	Old No.	Description	List Price
8.712-736.0	463650	VB9 w/ Knob	\$120.64
8.715-462.0		VB9 w/ Knob and Pressure Switch	\$177.84
8.715-489.0		VB9 w/ Check Valve and Pressure Switch	\$209.09
8.712-745.0	463675	VB10 w/ Knob	\$177.84
8.704-548.0	111336	Repair Kit VB9	\$37.88
8.704-561.0	111400	Repair Kit VB10	\$111.28
8.901-056.0	111401	Seal Kit VB10	\$36.09

VB350 / 4 Unloader

Bigger. Stronger. Faster – 5600 PSI



- 10.5 GPM
- Rated 5100 PSI
- Max 5600 PSI
- 195°F max
- Forged-bronze body
- 31 oz weight
- Stainless-steel plunger and valve seat
- 3/8" FPT outlet and bypass
- 1/2" F bypass
- 3/8" MPT inlet, 1/4" gauge port

Part #	Old No.	Description	List Price
9.802-360.0	463680K	Unloader Red Knob	\$169.95
8.704-499.0	111200X	Repair Kit Old VB 350	\$32.08
9.800-106.0	111901	Repair Kit – Red Knob Version	\$46.52

Control Set "W" Series / Integrated Regulator/Unloader



Designed exclusively to fit Interpump and General pumps.



- Mounts directly on pump inlet and outlet; internal bypass loop
- Pressure actuated: "Instant-On"
- 3/8" MPT outlets
- Integrated injector — optional
- Pressure- and flow-engineered for specific pump models

Part #	Old No.	Model	GPM	Fits PSI	Pump	List Price
"W" Series Unloaders						
8.712-638.0	462636	W1	4.00	1600	W905	\$180.09
8.712-640.0	462639	W1-L	4.00	1600	W99	\$142.83
8.712-643.0	462643	W2	5.56	3000	W997	\$193.44
8.712-644.0	462644	W2-L	5.56	3000	W201	\$213.20
8.702-883.0	103093B	W2/W2L Rebuild Kit				\$57.60
8.702-888.0	103098B	W1/W1L Rebuild Kit				\$204.93

"W" Series Unloaders with Injectors

8.712-637.0	462635	W1-0	2.1-2.9	1600	W907	\$178.02
8.712-641.0	462640	W1L-1	3.0-4.0	1600	W99	\$167.44
8.712-642.0	462642	W2-1	2.9-4.0	3000	W997	\$206.96
8.712-645.0	462645	W2L-1	2.9-4.0	3000	W201	\$197.60
8.712-647.0	462647	W2L-2	4.2-5.5	3000	WS202	\$213.20
8.702-884.0	103094B	Injector Maintenance Kit				\$13.31

"K" Series Pressure Regulators Kits



Repair Kits for All K3, K5, K7 and K9 models.

Part #	Old No.	Description	List Price
8.702-850.0	103061B	K3 Rebuild Kit	\$162.50
8.702-847.0	103058B	K5 Maintenance Kit	\$96.20
8.702-849.0	103060B	K5 Rebuild Kit	\$144.90
8.705-045.0	140070	K5 Back Nut 3/4" NPT	\$5.85
8.702-858.0	103070B	K7 Repair Kit	\$136.24
8.702-911.0	103121B	K9 Repair Kit	\$401.58

"K" Series Pressure Regulators



Unloaders relieve line pressure in bypass mode.

- 3/8" FPT Inlet
- 165°F
- 1/2" FPT B



K3 - 0 - 1500 PSI

List Price

\$137.28

Part #	Old No.	Model	GPM	Outlet
K3				
8.712-603.0	462530A	K3.0	2.10-2.90	3/8" M
8.712-605.0	462531A	K3.1	2.90-4.22	3/8" M
8.712-607.0	462532A	K3.2	4.22-5.55	3/8" M
8.712-609.0	462533A	K3.3	5.00-6.50	3/8" M
8.712-604.0		K3.0	2.10-2.90	1/2" M
8.712-606.0		K3.1	2.90-4.22	1/2" M
8.712-608.0		K3.2	4.22-5.55	1/2" M
8.712-610.0		K3.3	5.00-6.50	1/2" M

K5 - 1000 - 3000 PSI

List Price

\$147.68

K5

8.712-611.0	462551A	K5.1	2.90-4.22	3/8" M
8.712-613.0	462552A	K5.2	4.22-6.60	3/8" M
8.712-615.0	462553A	K5.3	6.60-10.83	3/8" M
8.712-612.0		K5.1	2.90-4.22	1/2" M
8.712-614.0		K5.2	4.22-6.60	1/2" M
8.712-616.0		K5.3	6.60-10.83	1/2" M

NOTE: 1) Use 8.705-045.0 back nut on bypass nipple when mounting 1/2" bypass line on K3s and K5s. 2) Use-restricted (.156 - .225 ID) orifice in bypass line for smoother operation/pressure balancing.

Part #	Description	List Price
8.715-478.0	Bypass plate for K3/K5	\$10.56



K7 - 0 - 3000 PSI

List Price

\$179.92

- 3/8" FPT
- 165°F

Part #	Old No.	Model	GPM	Outlet
8.712-617.0	462570	K7.0	2.11-2.90	3/8" M
8.712-618.0	462571	K7.1	2.90-4.22	3/8" M
8.712-619.0	462572	K7.2	4.22-6.60	3/8" M
8.712-620.0	462573	K7.3	6.60-10.8	3/8" M



ZK1 - 0 - 3600 PSI

List Price

\$154.22

- 2.3-10.8 GPM
- 3/8" inlet BSP-F
- 165°F

Part #	Old No.	Model	Outlet / Bypass
8.712-602.0	462526	2K138	3/8" BSP-M
8.712-601.0	462525	ZK1	1/2" BSP-M



K9 - 0 - 5800 PSI

List Price

\$877.76

- 1/2" FPT
- 165°F

Part #	Old No.	Model	GPM	Outlet
8.712-621.0	462574	K9	13.2	1/2" M

HM Regulator/Unloader



- Excess flow is bypassed to maintain selected pressure
- Will operate on single or multiple gun systems
- Brass body — stainless-steel valve and seat
- 3/8" FPT inlet
- 3/8" MPT outlet
- 3/8" FPT bypass
- Flow range – 1.4 to 10.8 GPM
- Pressure adjustable 0-3000 PSI

Part #	Old No.	Description	List Price
8.712-622.0	462575	HM Regulator/Unloader	\$145.23
8.702-860.0	103072B	Repair Kit	\$52.26

Hypro-Style Unloader



- All rated at 5 GPM
- Pressures from 400 to 1500 PSI
- 180°F
- Buna-N seals
- 3/8" MPT inlet and outlet
- 8 oz weight

Part #	Old No.	Pressure	Bypass	List Price
8.712-689.0	462739	200-500	1/4" FPT	\$86.74
8.712-690.0	462740	400-1000	1/4" FPT	\$86.32
8.712-691.0	462743	800-1500	1/4" FPT	\$79.57
8.712-692.0	462745*	400-1000		\$82.63
8.712-693.0	462748*	800-1500		\$154.96
8.722-643.0	H34300223		Repair Kit for All	\$9.68

*Bypass port not threaded, closed coupled

YU – High-Volume Unloader



- 21 GPM
- 1/2" FPT inlet, outlet
- 2-1/2" FPT bypass ports
- 200°F
- Forged-brass body
- Stainless-steel internals

YU-2121 Yellow Spring

- 2300 PSI
- 2600 PSI rated pressure

YU-2140 Green Spring

- 4050 PSI
- 4500 PSI rated pressure

Part #	Spring	List Price
8.753-326.0	Yellow	\$231.92
8.753-168.0	Green	\$229.14

ST-230 Regulator / Relief Valve



- 8 GPM
- Complete pressure regulation 0-3600 PSI
- 200°F
- 1/4" FPT inlet and bypass
- Mounts off-line — no line restrictions
- All brass body with stainless-steel piston and seat
- 14 oz weight

Part #	Old No.	Description	List Price
8.712-628.0	462590	ST-230	\$59.59
8.701-626.0	087926	Repair Kit	\$35.24

ST-261 Regulator / Unloader



- 8 GPM
- Stainless-steel plunger and seat
- 0-3600 PSI regulation
- Viton seals
- 180°F temperature rating
- Forged-brass body
- 22.5 oz weight

ST-261 Standard



Part #	Old No.	Description	List Price
8.712-681.0	462690	ST-261 STD	\$89.02
8.900-156.0	088211X	Seal Kit	\$17.68
8.701-627.0	088209	Repair Kit "B"	\$60.86
8.701-650.0	088466	Outlet Check Kit "A"	\$9.06

ST-261/S Unloader with Bypass Switch



- Switches at full bypass flow
- 10 Amp, 110/230V
- Wired N/C (may be wired N/O)

Part #	Old No.	Model	List Price
8.712-685.0	462695	ST-261/S	\$140.70
8.701-647.0	088422	Switch Seal Kit	\$18.79

ST-261/I Unloader with Chemical Injector



Part #	Old No.	GPM	Model	List Price
8.712-682.0	462691	0.0-2.4	ST-261/I-1	\$100.20
8.712-683.0	462692	2.4-3.5	ST-261/I-2	\$108.16
8.712-684.0	462693	3.5-5.5	ST-261/I-3	\$109.20
8.900-159.0	088260X		Injector Repr w/o Barb	\$7.61
8.701-648.0	088424		Injector Repr w/ Barb	\$10.76

ST-261/SI Unloader with Switch and Injector



- Switches at full bypass flow
- 10 Amp, 110/230V
- Wired N/C (may be wired N/O)

Part #	Old No.	GPM	Model	List Price
8.712-686.0	462696	0.0-2.4	ST-261/SI-1	\$173.68
8.904-576.0	462697	2.4-3.5	ST-261/SI-2	\$189.28
8.904-577.0	462698	3.5-5.5	ST-261/SI-3	\$185.12

ST-261 Bypass Switch only



- Field-mountable
- 10 Amp @ 115/230V
- Switches at full bypass flow
- Wired N/C (may be wired N/O)

Part #	Old No.	Description	List Price
8.712-629.0	462626	Switch Assy Complete	\$84.30
8.701-642.0	088272	Micro Switch Only	\$18.99
8.701-647.0	088422	Seal Kit – Micro Switch	\$18.79

ST-280 Regulator / Unloader



- 8 GPM
- 3600 PSI
- 175°F
- 27.5 oz weight
- Brass housing — stainless-steel valve
- 3/8" FPT inlet/outlet
- 1/4" FPT bypass

Part #	Old No.	Description	List Price
8.712-674.0	462680	ST-280	\$116.39
8.701-655.0	088536	Seat Repair Kit "D"	\$13.71
8.701-654.0	088535	Piston Seal Kit "C"	\$11.95
8.701-653.0	088534	Poppet Repair Kit	\$58.63

AR Bolt-On Unloaders



Mini-Mate Models.



- Fits XT and XM series pumps
- 2600 PSI-rated pressure
- 1-2" F inlet
- 3/8" M outlet

Part #	Old No.	AR Model No.	GPM	Bypass	List Price
8.712-582.0		AR20608	3-5.5	AL, No injector	\$190.32
8.712-564.0	462228	AR20821	2-5	AL, No injector	\$124.80
8.712-573.0	462243	AR20890	2-3	AL, Adj injector	\$146.64
8.712-576.0	462246	AR21039	2-3	Brass, Adj injector	\$148.72
8.712-575.0	462245	AR21040	3-4	Brass, Adj injector	\$148.72
8.720-676.0	AR002812	Seal Kit			\$7.76

NOTE: AR has discontinued the Combiset unloaders. Use Mini-Mate unloaders as replacements. For 22mm twist coupler outlet models, add part #8.709-546.0 (3/8" x 22mm) to injector outlet.

Gymatic Unloaders



- RK and XM series pumps
- 3650 PSI-rated pressure
- 3-5.5 GPM
- 3/8" M outlet

Part #	Old No.	AR Model No.	Inlet	List Price
8.712-565.0	462229	AR20242	1/2" F w/ no injector	\$158.08
8.712-563.0	462226	AR20242G	3/4" (GHF) w/ no injector	\$167.44
8.712-574.0	462244	AR20081	1/2" M fixed injector #1 (2-3 gal)	\$165.36
8.712-567.0	462233	AR20082	1/2" M fixed injector #2	\$165.36
8.712-568.0	462235	AR20399	1/2" M adj injector #1 (2-3 gal)	\$175.76
8.712-569.0	462236	AR20400	1/2" M adj injector #2	\$182.00
8.720-642.0	AR002611	Repair Kit		\$36.12

- Max PSI: 4000
- Max GPM: 5
- Inlet: 1/2" M
- Outlet: 3/8" M NPT
- Bypass: brass
- Without injector

Part #	Old No.	AR Model No.	List Price
8.712-583.0	462255	AR21669	\$191.36

- Max PSI: 4000
- Max GPM: 5
- Inlet: 1/2" F
- Outlet: 3/8" M
- Bypass: brass

Part #	Old No.	AR Model No.	List Price
8.720-903.0	AR20992	AR20992G	\$179.92

13 GPM Pressure-Actuated Unloaders



- 13 GPM
- 800-3000 PSI
- 160°F
- Bellville spring washers minimize spikes
- Forged-brass bodies/ stainless ball and seat
- Four 1/4" side ports enhance versatility
- 1/2" FPT inlet, outlet and bypass ports
- 57.3 oz weight

Part #	Old No.	Model No.	PSI	Spring	List Price
8.712-709.0	462934	22910	800	Silver	\$274.56
8.712-710.0	462935	22911	1400	Yellow	\$246.48
8.712-711.0	462937	22912	2400	Red	\$253.76
8.712-708.0	462933	22913	3000	Orange	\$224.12
8.722-137.0	G012099	Repair Kit			\$38.19

Pressure-Actuated Unloaders



8.712-705.0



8.712-706.0

- Unloads pressure in entire system when in bypass
- Forged-bronze body
- Stainless-steel seat
- 3/8" FPT inlet/ 3/8" FPT outlet
- 1/4" FPT bypass
- 160°F

Part #	Old No.	Model No.	GPM	PSI	List Price
8.712-705.0	462927	22760APM	8	3000	\$179.92
8.712-706.0	462928	22765APM	5	4000	\$385.84

Flow-Actuated Unloaders



- Unloads pressure in entire system when in bypass
- Forged-bronze body
- Stainless-steel seat
- 3/8" FPT inlet/ 3/8" MPT outlet
- 1/2" bypass
- 160°F

Part #	Old No.	Model No.	GPM	PSI	List Price
8.712-698.0	462909	22650	3.0-4.5	0-3000	\$200.72
8.712-701.0	462913	22654	3.5-4.8	3000-4000	\$192.40
8.712-702.0	462914	22655	4.5-5.5	0-3000	\$184.08
8.712-703.0	462915	22656	4.5-6.5	0-3000	\$189.28
8.722-204.0	G022666	Seal Kit			\$28.81

MG4000 Series Unloaders

"The world's best unloader valve" with a choice of PSI:
1500, 3000 or 4500.



- Forged-brass body
- 3/8" FPT inlet, outlet and bypass
- Auxiliary 1/4" outlet
- 10 GPM
- 200°F
- Up to 4500 PSI
- Can be panel mounted
- Pressure limit indicated with color coded ring

Part #	Old No.	PSI	Color	List Price
Without Knob				
8.712-715.0	463108	1500	Yellow	\$86.63
8.712-718.0	463110	3000	Red	\$95.48
8.712-724.0	463114	4500	Black	\$78.78
With Knob				
8.712-716.0	463108K	1500	Yellow	\$93.37
8.712-719.0	463110K	3000	Red	\$101.37
8.712-725.0	463114K	4500	Black	\$102.02
8.704-567.0	111442	Repair Kit		\$32.24

MG4000 with Microswitch



- Can be used as Normally Open (NO) or Normally Closed (NC)
- Use for time-delay shutdown or as burner control
- Up to 4500 PSI
- Panel mountable
- 15 Amp microswitch

Part #	Old No.	PSI	Color	List Price
8.712-717.0	463109K	1500	Yellow	\$130.00
8.712-720.0	463111K	3000	Red	\$118.56
8.712-714.0	463105K	3600	Blue	\$130.00
8.712-727.0	463115K	4500	Black	\$135.20

Safety Pressure Relief Valves

Engineered and built by Interpump. Premium-quality valves for all pressure systems.



- Adjustable pop-off protection
- Machined-brass bodies
- Stainless-steel plunger and seat
- 165°F
- 3/8" MPT connect x 1/4" MPT
- Bypass and outlet
- **S - R:** Safety valve - 3000 PSI @ 1.3 to 10.8 GPM
- **S - 3:** Safety valve - 500 to 10,000 PSI @ 2.6 to 26.5 GPM

Part #	Old No.	Description	List Price
8.711-215.0	390103	S - R Valve	\$78.30
8.711-227.0	390123	S - 3 Valve	\$647.91

Timax Pressure Regulator Valve



- Max flow 52 GPM
- Max pressure 1000 PSI
- Lever control manual dump for bypass to relieve line pressure
- 3/4" and 1" FPT inlet and outlet
- 3/4" FPT bypass
- Brass body - stainless-steel piston and seat

Part #	Old No.	Description	List Price
8.712-624.0	462580	Timax Reg Valve	\$272.48
8.702-844.0	103051B	Repair Kit	\$90.86

VS 200 / 180 High-Volume Regulator



- 53.5 GPM
- 2600 PSI
- 194°F
- 3/4" FPT inlet x 1/2" FPT bypass
- 29.4 oz weight

Part #	Old No.	Description	List Price
8.712-753.0	463705	VS 200/180	\$255.84
8.704-582.0	111520	Repair Kit	\$45.25

VS 350 Regulator / Relief Valve



- Rated pressure: 5100 PSI
- 5600 PSI
- 6.5 GPM
- 195°F
- 3/8" FPT inlet, outlet and bypass
- 16.8 oz weight

Part #	Old No.	Description	List Price
8.712-756.0	463720	VS 350	\$126.88
8.704-611.0	111832	Repair Kit	\$22.41

VS 500 High-Pressure Regulator / Relief Valve



- Forged-bronze body
- 21 GPM
- 7250 PSI-rated pressure
- 8100 PSI maximum pressure
- 195°F
- 1/2" FPT inlet and 3/8" FPT bypass
- 14.2 oz weight

Part #	Old No.	Description	List Price
8.712-757.0	463725	VS 500	\$524.75

VS 220 Regulator / Relief Valve



6.3 GPM - 3600 PSI max pressure



- Rated 3200 PSI
- 200°F
- Forged-bronze body
- Stainless-steel plunger and seat valve
- Two 3/8" FPT inlets
- 3/8" FPT outlet/bypass
- Compact design
- 14.2 oz weight

Part #	Old No.	Description	List Price
8.712-737.0	463655	VS 220 w/o Knob	\$56.86
8.901-057.0	111576	Repair Kit	\$10.35

Regulating Relief Valve

Economical replacement for paraplate BR5 Series.



- 7 GPM
- Pressure adjusts 200-2000 PSI
- 200°F
- 3/8" FPT inlet, outlet and bypass
- Flow-thru design for smooth operation
- Machined-brass body and knob
- Stainless-steel plunger and seal

Part #	Old No.	Description	List Price
8.712-625.0	462585	Relief Valve	\$74.16
8.900-042.0	075127	Repair Kit	\$8.37

Unloader Mounting Block

End vibration-caused fitting failure.



- 12 GPM
- Mounting hardware included
- Machine block brass or steel

Part #	Old No.	Description	Material	PSI	List Price
8.904-568.0	462183X	3/8" x 3/8"	Brass	5500	\$42.95
8.904-567.0	462182X	1/2" x 1/2"	Brass	5500	\$42.95
9.802-870.0		3/8" x 3/8"	Steel		\$39.47
9.802-871.0		1/2" x 1/2"	Steel		\$43.00

Amerimax Injector

The higher rate injector. Our best seller!



- Brass housing
- Stainless-steel orifice
- Fully adjustable metering valve
- Stainless-steel spring
- 3500 PSI
- 3/8" MPT inlet/outlet
- 1/4" hose barb

Part #	Old No.	Description	List Price
Standard			
8.904-192.0	360130	"0", 1-2 GPM	\$32.14
8.904-193.0	360131	"1", 2-3 GPM	\$31.05
9.803-998.0	360132	"2", 3-5 GPM	\$33.02
8.904-194.0	360133	"3", 5-8 GPM	\$32.14
8.900-040.0	075122X	Repair Kit (Stainless-Steel Check Ball)	\$5.49

"Acid" Injector w/ Special Inlet Check Valve

8.904-201.0	360140X	"0A", 1-2 GPM	\$37.52
8.904-202.0	360141X	"1A", 2-3 GPM	\$37.52
8.904-203.0	360142X	"2A", 3-5 GPM	\$33.27
8.904-204.0	360143X	"3A", 5-8 GPM	\$32.81
8.900-041.0	075123X	Acid Repair Kit*	\$8.54

*Ceramic check ball

Quick-Coupled Amerimax



Assembled for added convenience — quick couples to unloader outlet and quick couples hose to injector outlet.



- Top-quality quick couplers: 3/8" plug inlet, 3/8" socket outlet
- 6' industrial-grade poly-braid reinforced tubing (will not collapse, resists crimping, high-chemical tolerance)
- Heavy-duty brass chemical filter with check valve prevents loss of prime

Part #	Old No.	Description	List Price
Amerimax "QC"			
8.904-195.0	360135X	Quick-Coupled "0", 1-2 GPM	\$55.22
8.904-196.0	360136X	Quick-Coupled "1", 2-3 GPM	\$57.13
8.904-197.0	360137X	Quick-Coupled "2", 3-5 GPM	\$56.55
8.904-199.0	360138X	Quick-Coupled "3", 5-8 GPM	\$57.39
8.900-040.0	075122X	Repair Kit (Stainless-Steel Check Ball)	\$5.49

Amerimax Acid "QC"

8.904-205.0	360145X	Quick-Coupled "0A", 1-2 GPM	\$66.45
8.904-206.0	360146X	Quick-Coupled "1A", 2-3 GPM	\$66.45
8.904-207.0	360147X	Quick-Coupled "2A", 3-5 GPM	\$62.20
8.904-208.0	360148X	Quick-Coupled "3A", 5-8 GPM	\$60.19
8.900-041.0	075123X	Acid Repair Kit*	\$8.54

*Ceramic check ball

ST-60 Chemical Injector



Requires ST-61(below) to regulate chemical injection rate.



- Forged-brass body
- Compact size
- Forged-brass body
- Inlet 3/8" MPT
- Outlet 3/8" FPT

Part #	Old No.	Description	List Price
8.710-476.0	360120	1.50-2.25, ST-60/0	\$28.93
8.710-477.0	360121	2.25-3.35, ST-60/1	\$28.62
8.710-478.0	360122	3.35-5.00, ST-60/2	\$28.62
8.701-648.0	088424	Repair Kit "F"	\$10.76

ST-61 Chemical Metering Valve



- Snap-on attachment to ST-60, ST-62, ST-261/1 usage limited to these injectors
- Adjusts from off to full flow
- Glass-filled polyamide body and valve parts
- 1/4" hose barb
- Teflon® seals

Part #	Old No.	Description	List Price
8.710-777.0	371161	ST-61	\$23.13

ST-62 Variable Chemical Injector



Flow orifice adjusts for machines from 2-8 GPM. Requires ST-61 to regulate chemical injection rate.



- Forged-brass body
- 3500 PSI
- 8 GPM

Part #	Old No.	Description	List Price
8.710-485.0	360162	ST-62	\$55.17
8.701-648.0	088424	Repair Kit "F"	\$10.76

ST-64 Up Stream Injector



Apply soap at high pressure. Restricts waterflow to create suction.



- 140 PSI
- 160°F
- 3/4" FGH inlet
- 3/4" MGH outlet
- Chemical strainer and 4' PVC tubing included
- Adjustable with ST-61 meter valve
- Locking waterflow adjustment

Part #	Old No.	GPM	List Price
8.710-482.0	360155	1.5-4.0	\$70.64
8.710-483.0	360156	4.0-7.0	\$71.42

Robokim Chemical Injectors



- Forged-brass body
- Stainless-steel orifice
- Stainless-steel inlet check valve components
- 3500 PSI
- 180°F
- 3/8" MPT inlet/outlet
- 1/4" hose barb

Part #	Old No.	Description	List Price
Robokim w/ Plastic Meter Knob			
8.710-497.0	360200	"0", 2.1-2.9 GPM	\$41.40
8.710-498.0	360201	"1", 3.0-4.0 GPM	\$41.76
8.710-499.0	360202	"2", 4.0-5.5 GPM	\$41.40
8.710-500.0	360203	"3", 5.5-10.8 GPM	\$53.20
Robokim w/ Brass Meter Knob			
8.904-213.0	360220	"0", 2.1-2.9 GPM	\$49.11
8.904-214.0	360221	"1", 3.0-4.0 GPM	\$48.39
8.904-215.0	360222	"2", 4.0-5.5 GPM	\$48.08
8.904-216.0	360223	"3", 5.5-10.8 GPM	\$55.68
8.900-481.0	103053X	Repair Kit	\$8.80
8.900-061.0	077010X	Acid Kit	\$11.70

Robokim Quick-Coupled Chemical Injectors



- Quick-couplers: 3/8" QC plug inlet, 3/8" QC socket outlet
- 6' industrial-grade poly-braid reinforced tubing
- AP brass chemical filter w/ stainless-steel check valve

Part #	Old No.	Description	List Price
Robokim "QC" w/ Plastic Knob			
8.904-209.0	360210X	"0", 2.1-2.9 GPM	\$68.31
8.904-210.0	360211X	"1", 3.0-4.0 GPM	\$107.12
8.904-211.0	360212X	"2", 4.0-5.5 GPM	\$67.59
8.904-212.0	360213X	"3", 5.5-10.8 GPM	\$89.84
Robokim "QC" w/ Brass Knob			
8.904-217.0	360230X	"0", 2.1-2.9 GPM	\$70.59
8.904-218.0	360231X	"1", 3.0-4.0 GPM	\$65.31
8.904-219.0	360232X	"2", 4.0-5.5 GPM	\$67.22
8.904-220.0	360233X	"3", 5.5-10.8 GPM	\$82.59

Hi-Lo Injector



May be used on high or low side of pump. Adjustable flow orifices plus adjustable chemical valves. Standard features similar to ST-62.



- **Performance Range**
Low side: .5-3.5 GPM @ 10-120 PSI
High side: 2.0-8.0 GPM @ 3500 PSI
- Machined-brass body
- 3/8" FPT inlet/outlet

Part #	Old No.	Description	List Price
8.710-486.0	360163	Hi/Lo Injector w/ Meter Valve	\$71.02
8.710-487.0	360165	w/o Chemical Adjust	\$67.84
8.700-290.0	075136	Repair Kit	\$14.02
8.900-044.0	075136X	Seal Kit	\$8.49



400 Series Chemical Injectors

The injector of choice.



Orifice Selection

Orifice Dia.	Flow Rate
1.6mm	1.5-2.7 GPM
1.8mm	2.0-3.6 GPM
2.1mm	2.7-4.9 GPM
2.3mm	3.3-6.0 GPM

Adjustable Injectors, precise needle-metering valve.

Orifice Size(mm)	M x M Part No	M x M Old No	M x F Part No	M x F Old No	F x M Part No	F x M Old No
Brass						
1.6	8.710-541.0	360406	8.710-549.0	360416	8.710-559.0	360426
1.8	8.710-535.0	360400	8.710-543.0	360410	8.710-551.0	360420
2.1	8.710-537.0	360401	8.710-545.0	360411	8.710-554.0	360421
2.3	8.710-539.0	360402	8.710-547.0	360412	8.710-557.0	360422

Stainless-steel

1.6	8.710-542.0	360406S	8.710-550.0	360416S	8.710-560.0	360426S
1.8	8.710-536.0	360400S	8.710-544.0	360410S	8.710-552.0	360420S
2.1	8.710-538.0	360401S	8.710-546.0	360411S	8.710-556.0	360421S
2.3	8.710-540.0	360402S	8.710-548.0	360412S	8.710-558.0	360422S

Brass	List Price	Stainless-steel	List Price
	\$21.32		\$26.19

Part #	Old No.	Description	List Price
Repair Kits include Check Ball, Spring, Seat and O-ring			
8.900-769.0	109220X	Standard Kit	\$9.37

- Teflon® valve seat
- 3/8" inlet and outlet (3 configurations)
- Forged-brass housing
- 3200 PSI
- Renewable orifices and check valve
- 200°F
- Options include: quick-coupled, stainless-steel orifices/acid-resistant check
- Only 5 oz weight

Orifice Size(mm)	M x M Part No	M x M Old No	M x F Part No	M x F Old No	F x M Part No	F x M Old No
Brass/Acid-Resistant						
1.6	8.904-230.0	360406A	8.904-238.0	360416A	-	-
1.8	8.904-224.0	360400A	8.904-232.0	360410A	8.904-240.0	360420A
2.1	8.904-226.0	360401A	8.904-234.0	360411A	8.904-242.0	360421A
2.3	8.904-228.0	360402A	8.904-236.0	360412A	8.904-244.0	360422A

Stainless-steel/Acid-Resistant

1.6	8.904-231.0	360406AS	8.904-239.0	360416AS	8.904-246.0	360426AS
1.8	8.904-225.0	360400AS	8.904-233.0	360410AS	8.904-241.0	360420AS
2.1	8.904-227.0	360401AS	8.904-235.0	360411AS	8.904-243.0	360421AS
2.3	8.904-229.0	360402AS	8.904-237.0	360412AS	8.904-245.0	360422AS

Brass/Acid-Resistant	List Price	Stainless-steel/Acid-Resistant	List Price
	\$28.67		\$29.91

Part #	Old No.	Description	List Price
Repair Kits include Check Ball, Spring, Seat and O-ring			
8.900-770.0	109222X	Acid Kit	\$8.18

Series 505 Stainless-Steel

All metal parts are stainless-steel.



- Premier type injector
- 8 GPM
- 5650 PSI
- 3/8" inlet/outlet
- 195°F
- Teflon O-rings

Part #	Old No.	Description	GPM	List Price
8.710-586.0	360505/1.8	Stainless-Steel Injector 1.8	2.0-3.6	\$149.04
8.710-587.0	360505/2.1	Stainless-Steel Injector 2.1	2.7-4.9	\$146.26
8.710-588.0	360505/2.3	Stainless-Steel Injector 2.3	3.3-6.0	\$152.15
8.704-027.0	109234	Repair Kit		\$7.25

Adjustable Quick-Connect Injector



- 3500 PSI
- 200°F

Part #	Original No.	GPM	List Price
8.710-502.0	360240	2-3	\$34.22
8.710-503.0	360242	3-5	\$33.59
8.710-504.0	360244	5-8	\$33.90

Acid Injectors

8.904-221.0	360240A	2-3	\$44.30
8.904-222.0	360242A	3-5	\$44.30
8.904-223.0	360244A	5-8	\$44.30
8.701-187.0	080055	Injector Repair Kit	\$10.09
8.900-087.0	080056	Injector Acid Kit	\$9.99

Brass Injectors

All metal parts are brass.



- Premier type injector
- 3200 PSI
- 3/8" inlet/outlet
- 190°F

Part #	Old No.	Description	GPM	List Price
8.710-505.0	360245	Brass Injector 1.8	2.0-3.6	\$29.76
8.710-506.0	360246	Brass Injector 2.1	2.7-4.9	\$29.96
8.710-507.0	360247	Brass Injector 2.3	3.3-6.0	\$29.70
8.704-028.0	109235	Repair Kit		\$23.86

Exact-A-Flow Pressure Reducer/Injector

"Low side" chemical injector that regulates inlet pressure to maintain consistent chemical ratio.



- Up to 6 GPM
- 1/2" FPT I/O ports
- 1/4" hose barb chemical inlet
- ± 2% injection ratio variation

Part #	Old No.	Description	List Price
8.711-162.0	385127	Weep Seat*	\$178.02
8.711-160.0	385125	Non-Weep	\$189.41
8.711-161.0	385126	With Switch**	\$254.61
8.904-389.0	385128	Hose Barb w/ Viton Check	\$14.54
8.904-390.0	385129	Hose Barb w/ Buna Check	\$22.87

*Weep Seat allows pump to self-prime

**With burner control switch automatically turns burner off when water flow stops

Adjustable Bronze Float Valves



- Cast-bronze body
- Live rubber stopper
- Adjustable float arm
- 180°F

Part #	Old No.	Thread	Stem	GPM @ 40 PSI	List Price
8.710-041.0	343300	3/8"	1/4" - 20	10	\$26.86
8.710-043.0	343302	1/2"	1/4" - 20	17	\$30.48
8.710-044.0	343304	3/4"	1/4" - 20	31	\$36.33
8.710-045.0	343306	1"	1/4" - 20	47	\$56.30

NOTE: Float valves above require stem and float, below

Repair Parts for Adjustable Valves

8.700-475.0	076406	Long Arm*	\$7.81
8.700-476.0	076407	Short Arm*	\$6.13
8.700-477.0	076408	Thumb Screw*	\$2.30
8.700-479.0	076418	3/8" and 1/2" Plunger	\$11.49
8.700-480.0	076420	3/4" Plunger	\$12.11
8.700-481.0	076422	1" Plunger	\$16.56

*Fits 3/8", 1/2" and 3/4" valve only

Stems Only



9.802-157.0



8.710-047.0

Part #	Old No.	Length	Material	Thread	List Price
9.802-157.0	343310	8"	Brass	1/4" - 20	\$5.32
8.710-047.0	343310C	8"	Brass	1/4" - 20 x 5/16" - 18	\$3.31
8.710-048.0	343311	8"	Brass	5/16" - 18	\$3.11
8.710-051.0	343315	10"	Brass	1/4" - 20	\$3.47
8.710-049.0	343313B	18"	Brass	3/8" - 16	\$7.30
8.740-042.0	343316	19"	Brass	1/2" - 20	\$9.78

Parts for other float valves also available

Copper and Plastic Float Balls



8.710-053.0



8.710-054.0



9.802-061.0

Part #	Old No.	Length	Material	Thread	List Price
8.710-061.0	343326	4" x 5"	Copper	1/4" - 20	\$85.54
8.710-052.0	343317	5"	Copper	1/4" - 20	\$96.38
8.710-053.0	343318	6"	Copper	1/4" - 20	\$114.95

Plastic

8.710-057.0	343321	6"	Plastic	1/4" - 20	\$18.62
8.710-059.0	343323	8"	Plastic	1/4" - 20	\$43.60
9.802-061.0	343325	4" x 5"	Plastic	1/4" - 20	\$2.79

Parts for other float valves also available

PA Float Valve



- 140°F
- 3/8" BSP inlet
- Brass body
- Positional/adjustable arm
- 5 GPM @ 15 PSI
- 7 GPM @ 30 PSI

Part #	Old No.	Description	List Price
8.710-042.0	343301	3/8" Float Valve	\$33.01
8.704-204.0	110250	Repair Kit	\$19.10

Brass Float Valve Assembly



Complete assembly includes valve, stem and float.



- 1/2" FPT inlet
- Brass housing with polyamide cover
- 4.5 GPM
- 175°F

Part #	Old No.	Description	List Price
8.710-031.0	343010	ST-8	\$28.82
8.701-558.0	085331	Repair Kit	\$12.89

MPT Adapter Kit for ST-8*

8.710-033.0	343012	\$7.97
-------------	--------	--------

*Double MPT nipple, sealing washer and lock nut

Brass Float, Ball and Stem



- 142 PSI max inlet pressure
- 140°F
- 7.1 GPM @ 28 PSI - 1/2" MPT inlet
- Positive soft Buna/brass shut-off
- Adjustable float ball settings
- Inlet nut and washer seal provided

Part #	Old No.	Description	List Price
8.710-037.0	343050	Valve Complete	\$29.64
8.704-092.0	109502	Repair Kit	\$16.97

Diaphragm Float Valve



- Requires only 6.5" x 3" inside tank
- All-plastic snap-on float
- Positive shutoff diaphragm style
- Inlet screen, tank gasket and nut included
- Rebuildable — repair parts available
- 3/4" MPT inlet
- 142 PSI
- 7.86 GPM @ 28 PSI
- 6.68 GPM @ 14 PSI
- 140°F

Part #	Old No.	Description	List Price
8.710-030.0	343007	Float Valve Complete	\$19.56

Vertical Float Tank Valve



- 9 GPM @ 150 PSI - 1/2" MPT inlet
- 140°F
- Inlet nut and washer seal provided

Part #	Description	List Price
9.802-185.0	Vertical Float Tank Valve	\$23.29

Hudson Float Valve



- No external moving parts
- No float ball or arm
- Operates between 0-130 PSI
- All plastic, nylon, rubber and stainless-steel
- 90°F
- 1" inlet — easy installation
- Automatic anti-siphon
- Flow capacity 80% of supply (40 GPM @ 40 PSI)

Part #	Old No.	Description	List Price
8.710-035.0	343022	1" Hudson Float Valve, 90°	\$101.92
8.710-036.0	343026	1" Hudson Float Valve, 150°	\$112.27

Kerick Float Valve



- Flow rates for 1/2" valve:
- 10 PSI: 7.7 GPM
 - 20 PSI: 9.1 GPM
 - 30 PSI: 10.5 GPM
 - 40 PSI: 11.4 GPM
 - 60 PSI: 12.5 GPM
- Flow rates for 3/4" valve:
- 30 PSI: 13 GPM
 - 60 PSI: 16.5 GPM

Part #	Description	List Price
8.749-328.0	1/2" Float Valve, .25" orifice	\$18.54
8.749-329.0	3/4" Float Valve, .30" orifice	\$21.37

Check Valves – Swing Action

Retain prime on pumps with low-lift capability.



- Brass body with swing (flapper) action
- 150 PSI
- FPT inlet/outlet
- Gravity seal — no spring pressure

Part #	Old No.	Description	List Price
8.709-378.0	310862	1/2"	\$13.14
8.709-379.0	310863	3/4"	\$17.70
8.709-380.0	310864	1"	\$22.25
8.709-381.0	310865	1-1/4"	\$31.21
8.709-382.0	310866	1-1/2"	\$53.94
8.709-383.0	310868	2"	\$82.57

Stainless-Steel Check Valves



- Rated pressure: 5800 PSI
- 6500 PSI
- 195°F
- Female x female
- 2.0 oz weight

Part #	Old No.	Description	Flow Rate	List Price
8.709-361.0	310827	1/4" F x F	6.1	\$42.64
8.709-362.0	310828	3/8" F x F	10.5	\$43.16

High-Pressure Check Valves

2500 or 3000 PSI ball check.



- Buna seals
- Stainless-steel check ball
- Machined-brass body
- 1 PSI cracking pressure

Part #	Old No.	Description	List Price
8.709-356.0			
8.709-357.0			
8.709-358.0			

3000 PSI Stainless Guided Ball and Quad Ring Seat

Part #	Old No.	Description	List Price
8.709-358.0	310820	1/4", F x F	\$29.81
8.709-359.0	310822	3/8", F x F	\$28.67

Check Valves – 1200 PSI

Allows excellent low-restriction flow in inlet direction and instant positive-check action in reverse direction.



- Machined-brass body
- Poppet seal
- Cracking pressure 1 PSI

Part #	Old No.	Description	List Price
8.709-351.0	310804	1/4", F x F	\$14.70
8.709-352.0	310806	3/8", F x F	\$17.96
8.709-353.0	310808	1/2", F x F	\$22.10
8.709-354.0	310811	3/4", M x M	\$27.17

Brass Check Valves – Spring-Loaded

Holds pump prime without overloading pump suction.



- Machine-cast brass bodies, FPT x FPT
- 150 PSI
- 250°F
- Mount horizontal or vertical

Part #	Old No.	Description	List Price
8.709-384.0	310872	1/2"	\$14.75
8.709-385.0	310873	3/4"	\$17.49
8.709-386.0	310874	1"	\$25.62

Backflow Preventor – Check Valve

Protects water supply from harmful chemical backflow — will not allow "spike" pressure to push chemicals into supply line. **Now required by many city and state regulations.**



- 3/4" female garden hose inlet (with lock screw)
- 3/4" male garden hose outlet
- Machined-brass housing
- Plastic diaphragm check

Part #	Old No.	Description	List Price
8.705-039.0	140060	Backflow Preventor	\$9.11

UNLOADERS, INJECTORS, VALVES & GAUGES

PVC Check Valve

Holds pump prime without overloading pump suction.



- Designed for harsh chemical applications
- PVC plastic body
- Stainless-steel ball check
- Cracking press 1 PSI
- Choice of connects
- 125 PSI
- 180°F

Part #	Old No.	Description	List Price
8.709-366.0	310834	1/4" MPT x 1/4" Barb	\$14.49
8.709-367.0	310835	1/4" Barb x 1/4" MPT	\$14.75
8.709-369.0	310837	1/4" Barb x 1/4" Barb	\$14.75
8.709-370.0	310838	3/8" Barb x 3/8" Barb	\$14.49
8.709-373.0	310844*	1/2" Barb x 1/2" Barb	\$15.06

*8.709-373.0 has Viton seals

Stainless-Steel Ball Valves – 2000 PSI



- Full-flow ports
- Investment cast process
- Two-piece 316 stainless bodies
- Glass-filled Teflon® seals
- 180°F @ 2000 PSI
- 300°F @ 1000 PSI
- 350°F @ 300 PSI

Part #	Old No.	Description	List Price
8.709-265.0	306534	1/4" F x F	\$62.41
8.709-266.0	306536	3/8" F x F	\$62.36
8.709-268.0	306538	1/2" F x F	\$68.88
8.709-269.0	306540	3/4" F x F	\$91.75

Forged-Brass Ball Valves



- 600 PSI
- 180°F
- Forged-brass body
- Full-flow ports
- Teflon PTFE seals

M x F Part #	F x F Part #	M x M Part #	Size	List Price
8.709-249.0	8.709-250.0	8.709-251.0	1/4"	\$14.13
8.709-252.0	8.709-253.0	8.709-254.0	3/8"	\$11.95
8.709-255.0	8.709-256.0	8.709-257.0	1/2"	\$12.63
8.709-258.0	8.709-259.0	8.709-260.0	3/4"	\$17.70
8.709-261.0	8.709-262.0	8.709-263.0	1"	\$46.68

Nickel-Plated Brass Ball Valves



- Threaded FPT connects
- Chrome-plated ball
- Seats and seals have glass-filled Teflon®
- Full-flow bore

Part #	Old No.	Description	Working Pressure (PSI)	List Price
8.709-242.0	306504	1/4"	710	\$12.37
8.709-243.0	306506	3/8"	710	\$12.42
8.709-244.0	306508	1/2"	710	\$15.01
8.709-245.0	306512	3/4"	570	\$20.34
8.709-246.0	306516	1"	570	\$29.55
8.709-247.0	306520	1-1/4"	430	\$50.92
8.709-248.0	306524	1-1/2"	430	\$58.17
8.709-264.0	306532	2"	360	\$85.96

Mini Ball Valves



- Forged-brass body
- 600 PSI
- 180° handle movement

M x F Part #	F x F Part #	M x M Part #	Size	List Price
8.709-208.0	8.709-209.0	-	1/8"	\$7.50
8.709-211.0	8.709-212.0	8.709-213.0	1/4"	\$8.75
8.709-216.0	8.709-217.0	8.709-218.0	3/8"	\$9.57

High-Pressure Ball Valves



- Rugged carbon steel construction
- 2-way
- NPT (F x F) threads
- Blow-out proof stems
- Delrin ball seats
- Viton O-rings

Part #	Old No.	FPT	PSI	List Price
8.709-274.0	306552	1/4" x 1/4"	7350	\$63.91
8.709-276.0	306553	3/8" x 3/8"	7350	\$67.41
8.709-279.0	306554	1/2" x 1/2"	7350	\$72.56
8.709-282.0	306556	3/4" x 3/4"	5880	\$151.11
8.700-270.0	075080	Replacement handle – fits all sizes above		\$21.99
8.700-271.0	075089	Replacement screw for handle		\$1.25

Stainless-Steel, High-Pressure Ball Valves – 5800 PSI



- 316 stainless-steel body, ball and stem
- Viton O-rings
- Delron ball seats
- Full port

Part #	Old No.	FPT	PSI	List Price
8.709-277.0	306553S	3/8" x 3/8"	5880	\$348.80
8.709-280.0	306554S	1/2" x 1/2"	5880	\$382.95
8.709-283.0	306556S	3/4" x 3/4"	5880	\$609.62
8.709-286.0	306558S	1" x 1"	5880	\$731.75

Stainless-Steel, One-Piece Ball Valves – 800 PSI



- Standard port
- 316 stainless-steel body
- 300°F @ 800 PSI
- 350°F @ 400 PSI
- Suitable for steam



Part #	Old No.	FPT	List Price
8.709-287.0	306582	1/4" x 1/4"	\$39.95
8.709-288.0	306583	3/8" x 3/8"	\$36.74
8.709-289.0	306584	1/2" x 1/2"	\$37.26
8.709-290.0	306585	3/4" x 3/4"	\$49.06

Brass Mini Ball Valves



- Compact knob operation
- Brass housing-hex bar
- 220 PSI working pressure
- Designed to fit tight quarters
- Teflon® seals
- Only 1-3/4" long

Part #	Old No.	FPT	List Price
8.709-270.0	306542	1/8" x 1/8"	\$11.95
8.709-271.0	306544	1/4" x 1/4"	\$12.42
8.709-272.0	306546	3/8" x 3/8"	\$12.42
8.709-273.0	306548	1/2" x 1/2"	\$14.13

PVC Ball Valves

Great for chemical on/off flow control.



- PVC and nitrile material
- Chemical and impact resistant
- Flag handle
- 180°F
- 125 PSI

Part #	Old No.	Description	List Price
8.709-214.0	306352P	1/4" Panel Mtg, Barb x Barb	\$22.20
8.709-219.0	306354P	1/4" In-line, Barb x Barb	\$14.44
8.709-220.0	306356	3/8" In-line, Barb x Barb	\$14.90

Polypropylene Ball Valves

Full port reinforced polypropylene.



8.709-222.0

8.709-228.0

- 150 PSI working pressure
- Easy turn w/ Teflon® seals
- Double seal in stem for "no leak"
- Threaded mounting bosses, brass insert on 1-1/4"- 2" sizes

Part #	Old No.	FPT	List Price
Two-Way Ball Valves			
8.709-222.0	306390	1/2" x 1/2"	\$27.58
8.709-223.0	306392	3/4" x 3/4"	\$28.10
8.709-224.0	306394	1" x 1"	\$34.67
8.709-225.0	306398	1-1/2" x 1-1/2"	\$58.89
8.709-226.0	306400	2" x 2"	\$76.38

Three-Way Ball Valves

8.709-227.0	306408	1/2" x 1/2" x 1/2"	\$34.62
8.709-228.0	306412	3/4" x 3/4" x 3/4"	\$33.43
8.709-229.0	306416	1" x 1" x 1"	\$41.92
8.709-230.0	306420	1-1/4" x 1-1/4" x 1-1/4"	\$65.93
8.709-231.0	306422	1-1/2" x 1-1/2" x 1-1/2"	\$59.00
8.709-232.0	306424	2" x 2" x 2"	\$82.49

Compact PVC Ball Valves



- FPT thread both ends
- 150 PSI working pressure
- Easy-turn handle
- 150°F
- EPDM seals – white body

Part #	Old No.	FPT	List Price
8.709-233.0	306444	1/4" x 1/4"	\$9.32
8.709-234.0	306448	1/2" x 1/2"	\$7.56
8.709-235.0	306450	3/4" x 3/4"	\$8.69
8.709-236.0	306452	1" x 1"	\$11.18
8.709-237.0	306454	1-1/4" x 1-1/4"	\$15.16
8.709-238.0	306456	1-1/2" x 1-1/2"	\$25.72
8.709-239.0	306460	2" x 2"	\$33.59

3-Way Ball Valve



- 400 PSI maximum pressure
- 180°F maximum temperature
- Teflon seat
- Buna seals
- Brass

Part #	Old No.	Description	List Price
8.709-207.0	306331	1/4" M x F x F	\$29.96

Flow Selector Valve



3-way and 4-way lever control with brass body.

- **3-way**
Plumb for 2 inlets and 1 outlet or 1 inlet and 2 outlets
- **4-way**
Plumb for 3 inlets and 1 outlet or 1 inlet and 3 outlets
- 180°F rated temperature

Part #	Old No.	Description	List Price
8.710-108.0	343734	1/4" FPT 3-Way	\$46.52
8.710-110.0	343736	3/8" FPT 3-Way	\$50.97
8.710-113.0	343744	1/4" FPT 4-Way	\$41.04
8.710-114.0	343746	3/8" FPT 4-Way	\$46.11

Flow Control Metering Valve



- Forged-brass, nickel-plated body
- Panel mtg in 17/32" hole
- Compact size
- Double-stem seal
- 300 PSI
- 175°F rated temperature

Part #	Old No.	Description	List Price
8.710-775.0	371125	1/4", FPT In/out	\$25.72
8.710-776.0	371133	3/8", FPT In/out	\$44.25

Flow Control Metering Valve

The valve that "seals" (will not suck air).



- 3500 PSI to 28" vacuum — no leak
- Viton gland seal isolates metering threads from solution
- Stainless-steel needle/brass seat
- 1/4" FPT ports
- Heavy-duty brass bar stock body
- 195°F rated temperature
- Panel mounts 5/8" hole
- Large easy-grip four-lobe handwheel
- Aluminum or poly available

Part #	Old No.	Description	List Price
8.904-362.0	371120X	Metering Valve / Alum Knob	\$25.93
8.904-361.0	371120P	Metering Valve / Poly Knob	\$25.46
8.740-083.0	077003A	Replacement Knob	\$1.97

Brass Metering Valve



- Easy-grip, fluted plastic handle with pointer
- Brass body, Viton gland seal eliminates air leaks
- Panel mount 11/16" or 3/4" hole
- Extremely compact T-style
- 1/4 inlet/outlet
- 450 PSI
- 170°F

Part #	Old No.	Description	List Price
8.710-773.0	371115	"T" 1/4" F x F – Forged	\$30.64
8.710-774.0	371116	"L" 1/4" M x M – Machined	\$27.74
9.802-188.0		"L" 1/4" M x M	\$31.51



Chemical Metering Valves



9.802-187.0

- Adjusts from off to full flow
- 4000 PSI
- 1/4" FPT inlet – outlet
- 6 GPM
- 9.802-187.0 has presettable limiting orifice

Part #	Old No.	Description	List Price
8.710-771.0	727628	Flow Control	\$27.55
9.802-187.0	2-30151	Flow Control w/ Locking Adjustment	\$53.87
9.802-532.0		Valve, Less Solenoid	\$95.15

Chemical Metering / On-Off Valve



- Dual-knob control — calibrate chemical flow w/ base knob. Outside knob allows on/off control without changing calibration
- Single 1/2" hole panel mounting
- Brass and stainless-steel materials

Part #	Old No.	Description	List Price
8.710-770.0	371100	MV-100	\$53.25

ST-66 Chemical Meter and Selection Valve



- Two input bars — for different chemicals to single outlet barb
- Double-metering dial with center OFF
- Panel mount in single 5/8" hole

Part #	Old No.	Description	List Price
8.710-779.0	371166	ST-66	\$20.86

Steam Valve

For "combo" hot pressure washer/steamer units. The single-turn on/off diverter valve bypasses pump flow to reduce water flow to the coil, creating steam in place of normal hot water.



- Panel mount in 11/16" or 3/4" hole
- Machined-brass body
- Easy-grip plastic knob
- 3600 PSI
- 175°F
- 1/4" MPT inlet/outlet

Part #	Old No.	Orifice (mm)	List Price
8.711-263.0	400008	0.8	\$35.35
8.904-406.0	400012	1.2	\$33.76
8.904-407.0	400015	1.5	\$41.92
8.904-408.0	400018	1.8	\$41.92
8.904-409.0	400020	2.0	\$35.60

Thermal Relief Valves

A MUST for any pump that might ever be left in bypass mode (unloading) for more than 15 seconds. Protects the pump from overheating caused by recirculating water.



- Installs in bypass line
- Automotive style wax element
- Automatically resets at cool down to 115°F + F
- No adjustment required
- 1/8" FPT side discharge
- 125 PSI inlet pressure
- 2.5 GPM flow

Part #	Old No.	Inlet	"Trip" Temp	List Price
8.904-564.0	458000	1/4" MPT	140°F	\$35.71
8.904-565.0	458001	3/8" MPT	140°F	\$35.09
8.904-566.0	458005	1/2" MPT	140°F	\$37.42
8.723-943.0	458007	1/2" MPT	165°F	\$58.89

Compact Thermal Relief Valves



- 145°F or 190°F "Trip" temperature

Part #	Old No.	Size	"Trip" Temp	List Price
8.712-544.0	458024	1/4" MPT	145°F	\$22.46
8.712-545.0	458026	3/8" MPT	145°F	\$22.15
9.802-181.0	921421	3/8" MPT	145°F	\$7.50
9.804-025.0		1/4" MPT	145°F	\$9.06
8.707-250.0		3/8" MPT	190°F	\$18.18
9.803-670.0		1/2" MPT	190°F	\$19.04

TRV Thermal Relief Valves



- Low profile
- Brass body
- Plastic-covered barb
- 7mm hose barb
- 145 PSI
- Opens at 145°

Part #	Old No.	Inlet	List Price
8.712-547.0	458032	3/8"	\$20.86
8.712-548.0	458034	1/2"	\$22.72

Flow Meters

The answer to precision calibration and efficient operation of pressure washing systems.



- Flow scale measures gallons per hour (GPH)
- 100 PSI
- 150°F
- 1/8" FPT inlet and outlet port
- Wetted parts are brass or stainless-steel, with or without metering valves
- Accurate within ±5%
- Precision-cut and machined-clear acrylic
- Metal mounting inserts for ease of installation (10-32 threads)
- Compact size — 2" tall scale, 4-3/32" overall height

Part #	Old No.	GPH	Metal	Metering Valve	List Price
8.710-097.0	343722	.6-5	Brass	No	\$83.06
8.710-098.0	343723	.6-5	Brass	Yes	\$117.99
8.710-101.0	343726	2-10	Brass	No	\$93.72
8.710-102.0	343727	2-10	Brass	Yes	\$108.68
8.710-099.0	343724	.6-5	Stainless-Steel	No	\$117.99
8.710-100.0	343725	.6-5	Stainless-Steel	Yes	\$146.97
8.710-104.0	343728	2-10	Stainless-Steel	No	\$97.03
8.710-105.0	343729	2-10	Stainless-Steel	Yes	\$143.87

NOTE: All flow measurements must be on low-pressure side of pump.

Rupture Disks



- Prevents dangerous thermal expansion of water in the coil
- Ensures operator safety

Part #	Old No.	Description	List Price
9.802-192.0	2-3409	Assembly, 7000 PSI	\$47.17
8.707-381.0		Assembly, 8500 PSI	\$57.58

Safety Pressure Relief Valves



- Prevents pressure overloads, protecting people and equipment
- Machined brass
- Automatically resets

Part #	Old No.	Max PSI	Size	List Price
8.722-192.0	G022550A	1200 (Silver Spring)	1/4"	\$21.63
8.722-193.0	G022560A	2400 (Red Spring)	1/4"	\$21.58
8.722-194.0	G022565A	3600 (Orange Spring)	1/4"	\$22.05
8.722-190.0	G022532A	3600 (Orange Spring)	3/8"	\$24.27
9.802-191.0	G022533A	5000 (Blue Spring)	3/8"	\$19.78

Air Valve – Coil Blow Out

Install in-line in front of coil and use air pressure to blow water out of coil to prevent "freeze-up".



- Threaded connection
- 1/4" brass valve
- 1/8" model is stainless-steel
- Valve cap included

Part #	Old No.	Description	List Price
8.705-047.0	140073	1/8" Stainless-steel Connect	\$5.02
8.705-048.0	140075	1/4" Connect	\$5.85
8.902-426.0		Valve Assy, Water Blow-Out	\$29.86
8.707-314.0		Valve Assy, Water Tank Blow-Out	\$28.26

Easy-Start Valve



- 1/8" FPT outlet
- Machined-brass housing
- Hose barb outlet
- Stainless-steel internal
- 200°F
- 8 GPM

Part #	Old No.	Description	List Price
9.804-065.0		Easy-Start Valve, 1/4" MPT, 5000 PSI	\$21.74
9.802-190.0		Easy-Start Valve, 3/8" MPT, 5000 PSI	\$22.77
8.709-865.0	339004	Easy-Start Valve, 3/8" MPT, 4100 PSI	\$20.50
8.709-866.0	339005	Easy-Start Valve, 3/8" MPT, 3500 PSI	\$29.27
8.751-265.0		Valve, 5/16" HB Outlet, 5000 PSI	\$39.80
9.802-137.0	140352	Hose Barb, 1/8" x 1/4" barb	\$1.09

Easy-Start Valve



- 3/8" MPT inlet
- Hose barb outlet (8 mm)
- Machined-brass body
- Stainless-steel spring and ball
- 3200 PSI
- 176°F
- 7.8 GPM

Part #	Old No.	Description	List Price
8.709-867.0	339006	Easy-Start Valve	\$25.36

Steel Utility Gauges



- Black lacquered steel case
- Bronze bourdon tube
- Dry gauge
- 1/4" NPT brass mounting stem
- Accuracy ± 3-2-3%

Part #	Old No.	Pressure Range	List Price
2" bottom mount			
8.710-307.0	348552	0-60 PSI	\$9.11
8.710-308.0	348554	0-100 PSI	\$9.11
8.710-309.0	348558	0-200 PSI	\$9.21
8.710-310.0	348560	0-300 PSI	\$9.21

Fuel Oil Pressure Gauge



- 0-200 PSI
- Perfect for testing burner pump fuel pressure

Part #	Old No.	Pressure Range	List Price
8.700-738.0	079020	0-200 PSI	\$11.54

Corrosion-Resistant ABS Gauge



- Acid and alkali proof plastic case
- Bronze bourdon tube
- 1/4" NPT brass mounting stem
- Accuracy – Dry: ±3-2-3%
Filled: ±1.5%

Part #	Old No.	Pressure Range	List Price
8.710-291.0	348305	0-100 PSI	\$26.08
8.710-293.0	348307	0-200 PSI	\$23.86
8.710-294.0	348308	0-300 PSI	\$23.49
8.710-295.0	348312	0-1000 PSI	\$22.72
8.710-296.0	348313	0-2000 PSI	\$26.08
8.710-297.0	348314	0-3000 PSI	\$23.39
8.710-299.0	348316	0-5000 PSI	\$23.86

Pressure Gauges



- 5000 PSI cold water
- 1-3/4" gauge
- 3/8" QC socket
- 3/8" QC plug

Part #	Description	List Price
8.712-208.0	Pressure Gauge Kit	\$31.05

Stainless-Steel Pressure Gauges



- AISI 304 stainless-steel case
- Bronze bourdon tube
- 99.5% pure glycerin filled
- PSI and bar dual scale
- 1/4" NPT brass mounting stem
- Convex magnifying lens for easy reading
- Steel needle and peg
- Accuracy $\pm 1.5\%$

Part #	Old No.	Pressure Range	List Price
2-1/2" Bottom Mount with Bronze Internals			
8.710-270.0	348216	0-100 PSI	\$21.06
8.710-272.0	348220	0-200 PSI	\$22.05
8.710-273.0	348224	0-300 PSI	\$22.25
8.710-276.0	348230	0-500 PSI	\$22.25
8.710-278.0	348240	0-1000 PSI	\$14.70
8.710-280.0	348245	0-2000 PSI	\$14.75
8.710-281.0	348250	0-3000 PSI	\$21.99
8.710-283.0	348255	0-4000 PSI	\$21.79
9.804-017.0	348260	0-5000 PSI	\$20.50
8.710-286.0	348262	0-6000 PSI	\$22.46
9.804-001.0	348265	0-10,000 PSI	\$27.17
2-1/2" Back Mount with Bronze Internals			
8.710-246.0	348125	30Hg - 0 Vacuum	\$27.58
8.710-250.0	348140	0-100 PSI	\$25.00
8.710-254.0	348150	0-500 PSI	\$25.10
8.710-256.0	348152	0-1000 PSI	\$27.58
8.710-257.0	348154	0-2000 PSI	\$27.32
8.710-258.0	348156	0-3000 PSI	\$27.32
8.710-259.0	348158	0-4000 PSI	\$27.58
8.712-149.0		0-5000 PSI	\$27.58
8.712-150.0		0-6000 PSI	\$25.70
8.710-262.0	348162	0-6000 PSI	\$27.58
9.804-013.0	348165	0-10,000 PSI	\$32.86
Mounting Hardware for Back Mount Gauges			
8.710-223.0	348001	U-bracket	\$5.59
8.710-228.0	348090	3-hole flange, mounted	\$5.85

Pressure and Temperature Test Set



Convenient test set provides both pressure and temperature check with one easy quick coupled connection at outlet of unloader or coil.



- **Test Set 5000**
500°F thermometer
5000 PSI pressure gauge
for systems up to 2000 PSI
- **Test Set 10,000**
10,000 PSI pressure gauge
for systems up to 5000 PSI

Part #	Old No.	Description	List Price
8.904-559.0	449045	Test Set 5000 (0-2500 PSI systems)	\$114.89
8.904-558.0	449040	Test Set 10,000 (0-5000 PSI systems)	\$105.57

Speedmaster Throttle Control



Stop overworking the engine and pump during bypass. Decelerator reduces engine speed when pump head pressure drops below 215 PSI, reduces flow during bypass, slows recirculation heat build-up.



- 3500 PSI
- 300°F
- A major system saver for gas engine units
- Machined-brass body
- Stainless-steel gland components
- 1/4" male connect
- Viton seals
- 42" lined and covered control cable
- Engine speeds infinitely adjustable for "fine tuned" system performance

Part #	Old No.	Description	List Price
8.903-840.0	339000A	Throttle Control	\$83.42

Temperature Gauges



Dial thermometers.



- 3" diameter dial — stainless-steel case
- Shatter-resistant polycarbonate lens
- Stainless-steel stem (2.5")
- 1/2" MPT connector
- Accuracy to within 3% of dial range (50-500 = $\pm 6.8^\circ\text{F}$)

Part #	Old No.	Description	List Price
8.712-488.0*	426410	Temp Gauge +50° to 500°F	\$33.95

*"Thermowell" to be used with dial thermometers in systems over 300 PSI. For best results, fill thermowell with liquid silicon or glycol to increase sensitivity and accuracy of readings.

Thermowell for temperature gauge above

- Stainless-steel 3/4" MPT x 1/2" FPT
- Gives 2000 PSI collapse protection
- 1.75" immersion length

Part #	Old No.	Description	List Price
8.712-489.0	426423	Thermowell for 8.712-488.0	\$32.86

AMP and Voltmeters



- Designed for OEM or replacement
- Accuracy to $\pm 5\%$
- Metal case
- Rugged and weather-resistant
- Bright stainless bezel
- Utilize as constant monitor or as test instruments
- Fits 2-1/16" mounting hole

Part #	Old No.	Description	List Price
8.701-686.0	091321	-15 to +15 Amps	\$22.15
8.701-687.0	091323	-20 to +20 Amps	\$24.12
8.701-688.0	091344	-60 to +60 Amps	\$18.16
8.712-159.0		Voltmeter 120V	\$49.78

Hour Meters for Gasoline Engines



- Elapsed time
- No battery required
- Digital quartz accuracy ($\pm .02\%$)
- Extremely rugged and tamperproof
- Sealed from dirt and moisture
- Requires 2" panel cutout

Part #	Description	List Price
8.749-183.0	EL 5-80V AC/DC 50/60 Hz	\$39.85
8.749-316.0	EL 24-277 AC/DC 50/60 Hz	\$39.43
9.802-283.0	115/240V AC – Rectangle	\$46.00
8.904-540.0	Tach/Hour 12V DC w/ Magnet Tool	\$92.94



Briggs & Stratton Engines – Gasoline

Briggs & Stratton's top-of-the-line engines have proven performance in the pressure washer industry. They contain the power to complete any job faster and easier with less wear and tear on major engine components.



- Easy, quick-starting
- Large fuel tank
- Super-quiet muffler
- OilGuard® low-oil shutdown

Part #	Old No.	HP	Shaft Diameter	Starter	Charge Rate	Fuel Tank	Model No.	List Price
9.802-325.0	5-0309	16	1"	Electric	20 Amp	N/A	Vanguard	\$2,706.53
8.715-067.0	5-0316	21	1"	Electric	N/A	N/A	Vanguard	\$2,953.89

NOTE: Mufflers for the above engine are sold separately. See Briggs & Stratton Engine Parts section below.



OHV Vanguard

- State-of-the-art carburetion system
- 30% quieter muffler than competition
- Cast/sintered iron sleeve
- OilGuard® low-oil shutdown

Part #	Old No.	HP	Shaft Diameter	Starter	Charge Rate	Fuel Tank	Model No.	List Price
8.709-877.0	5-0313	11	1"	Recoil	N/A	2 gal	Vanguard	\$2,053.44

Briggs & Stratton Engine Parts



Genuine Briggs & Stratton replacement parts are available. Please provide engine model/type/code to ensure proper fit of replacement parts.



8.701-826.0



8.701-823.0



8.701-820.0

- Authorized manufacturer replacement parts
- Don't settle for cheap imitations

Part #	Old No.	Description	List Price
8.701-826.0	091960	Briggs 16/18 HP Vanguard, Oil Filter	\$19.46
8.701-820.0	091950	Briggs 5 HP Industrial, Air Filter	\$15.16
8.701-821.0	091952	Briggs 8 or 11 HP IC, Air Filter	\$57.86
8.701-823.0	091954	Briggs 16/18 HP Vanguard, Air Filter	\$25.00
8.718-021.0		Sparkplug, Vanguard, RC12YC	\$7.87

Honda Engine Parts



Original Honda replacement parts from the factory. Filters are a great add-on to every service order.



8.701-764.0



8.701-783.0



8.701-782.0



- Authorized manufacturer replacement parts
- Don't settle for cheap imitations

Part #	Old No.	Description	List Price
8.701-830.0	091970	Honda 18/20 HP, Oil Filter	\$17.03
8.701-764.0	091746	Honda GX160, Air Filter	\$37.26
8.701-780.0	091775	Honda GX240/270, Air Filter	\$40.00
8.701-781.0	091777	Honda GX340, Air Filter	\$58.06
8.701-782.0	091779	Honda GX610/620, Air Filter (old style)	\$80.37
8.701-783.0	091779A	Honda GX610/620, Air Filter (new style)	\$72.45
8.718-117.0		Honda GX All, Sparkplug	\$7.25

Kohler Lombardini Engines – Diesel



Kohler Lombardini Water Cooled Diesel Engines provide superior power and quiet operation.



- Diesel powered
- Water cooled

Part #	Old No.	HP	Shaft Diameter	Starter	Charge Rate	Fuel Tank	Model No.	List Price
9.802-327.0	5-0407	27	1-1/2"	Electric	N/A	No	LDW1003, Water Cooled	\$9,694.85

Kohler Lombardini Engine Parts



Factory direct Kohler parts.



8.717-912.0

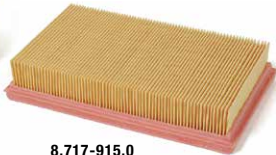

8.717-915.0

- Authorized manufacturer replacement parts

Part #	Old No.	Description	Engine Model	List Price
8.717-912.0	74-2175107	Oil Filter	LDW602/903/1003	\$65.46
8.717-915.0	74-2175164	Air Filter	LDW602/903/1003	\$72.24
8.717-909.0	74-2175045	Fuel Filter	LDW602/903/1003	\$61.53

12V DC Starter Solenoid

Universal type used on many lawn and garden tractors and mowers.



- Double terminal – 5/16" – 24 studs
- Same as used on 16 HP B & S Vanguard engines
- Rated for intermittent duty (i.e. for starting small gasoline engines)

Part #	Old No.	Description	List Price
8.701-691.0	091357	12V DC Starter	\$20.75

Keyed Ignition Switch – 12V DC



- Universal style/5 pole
- Off-On-Start (spring back to On)
- Panel nut and star-lock washer
- Two keys included
- Has two auxiliary circuits
- Universal — used for small engine controls on many lawn and garden tractors, mowers

Part #	Old No.	Description	List Price
8.701-689.0	091350	Keyed Ignition Switch, 5 pole	\$28.77
8.701-690.0	091351	Keyed Ignition Switch, 6 pole	\$73.17

Baldor Motors – Open Drip Proof (ODP)

Industrial-grade motors built specifically to meet or exceed the demands of the pressure washer industry.



1 Phase
56 Frame

- The industry standard
- U.L. Listed
- Any Baldor motor available



1 Phase
184T Frame



3 Phase
184T Frame

Part #	Old No.	Motor HP	Voltage	RPM	Shaft Dia	Frame	Full Load Amps	Model	List Price
Single-Phase Motors									
9.802-339.0	5-1047	2.0	115/230V	3450	5/8"	56C		35R613R717G1	\$430.54
8.715-157.0	5-1071	2.0	115V	1725	5/8"	56		35Q371R021G1	\$540.69
9.802-340.0	5-1048	3.0	230V	3450	5/8"	56C		35R613Y771G1	\$546.48
8.715-090.0	5-10081	3.0	208/230V	1725	5/8"	56HC		35M895T356	\$528.89
8.709-751.0	337320	3.0	115/230V	1725	1-1/8"	184T	32/16		\$859.05
9.802-341.0	5-1053	5.0	208/230V	3450	3/4"	56CZ		35V142S241G1	\$568.56
8.715-146.0	5-1053E	5.0	208/230V	3450	3/4"	56CZ		35L3583214G1	\$718.29
8.715-091.0	5-10104	5.0	230V	1725	7/8"	184TCZ		36G472W849	\$1,301.00
8.709-759.0	337331	5.0	208/230V	3450	5/8"	56	23-21		\$718.29
8.709-757.0	337329	5.0	208/230V	1725	1-1/8"	184T	25/23		\$1,026.72
9.802-336.0	5-10401	6.2	230V	1725	1-1/8"	184TZ		36J185X288G1	\$1,012.49
9.802-331.0	337279	7.5	1P208/230V	1725	1-3/8"	215T	3-31		\$1,331.01
8.715-163.0	5-1080	8.2	208V	1725	1-3/8"	215		N/A	\$1,656.00
8.715-165.0	5-1082	8.2	230V	1725	1-3/8"	215		N/A	\$1,523.52
9.804-045.0	5-1016	10.0	230V	1725	1-3/8"	215T		L1512T	\$2,192.87
Three-Phase Motors									
8.751-013.0	337529	5.0	208/230/460	1750	1-1/8"	184T	14/13.2/6.6		\$1,049.49
8.751-004.0		6.2	208/230/460	1725	1-1/8"	184T		36B101Y483H2	\$1,099.01
8.751-014.0	337534	7.5	208/230/460	1770	1-3/8"	213T	20.4/19.4/9.7		\$1,383.29
8.750-998.0		8.2	208V	1725	1-3/8"	215		N/A	\$1,367.24
8.750-999.0		8.2	230/460V	1725	1-3/8"	215		N/A	\$1,421.06
8.751-015.0	337540	10.0	230/460	1770	1-3/8"	215T	25/12.5		\$1,511.01
8.751-006.0	337545	15.0	230/460	1760	1-5/8"	254T	35.4/17.7		\$2,084.49

NOTE: Amp draw ratings require adequate wire size and full voltage to apply. Full load Amp ratings apply only when full rated.

Baldor Motors – C-Face Open Drip Proof (ODP)



Built to “industrial” specifications. “S” indicates motor has on/off switch. “B” indicates motor is black.



Part #	Old No.	Motor HP/S	RPM	Shaft Dia	Bolt Circle	Frame/C-Face	Full Load Amps	Voltage	List Price
Single-Phase Motors									
8.709-747.0	337311	2.0	1725	5/8"	5-7/8"	56/56C	18.4/9.2	115/230	\$609.03
8.709-714.0	337240B	2.0S	1725	5/8"	5-7/8"	56/56C	18.4/9.2	115/230	\$650.96
8.709-754.0	337323B	3.0	3450	5/8"	5-7/8"	56/56C	13.7/12.5	208/230	\$688.28
8.709-723.0	337264B	3.0	1725	5/8"	5-7/8"	184CZ/56C	32/16	115/230	\$1,008.09
8.709-727.0	337268B	4.0	1725	5/8"	5-7/8"	182TCZ/56C	17.5/16	208/230	\$1,101.24
8.709-728.0	337269B	4.0	3450	5/8"	5-7/8"	56/56C	38/21/19	115/208/230	\$720.36
8.709-730.0	337271B	5.0	1725	1-1/8"	7-1/4"	184TC	25/23	208/230	\$1,068.32
8.709-731.0	337272B	5.0	3450	5/8"	5-7/8"	56HCY/56C	24/23	208/230	\$775.59
8.709-733.0	337273B	6.0	1725	1-1/8"	7-1/4"	213C/182TC	26	230	\$1,253.51
8.709-734.0	337275B	7.5	1725	1-1/8"	7-1/4"	215C/182TC	36/33	208/230	\$1,752.03

Three-Phase Motors

8.751-797.0	337520	3.0	1760	1-1/8"	7-1/4"	182TC	8.4/4.2	230/460	\$1,189.22
8.751-798.0	337535	7.5	1770	1-3/8"	7-1/4"	213TC	20.4/19.4/9.7	208/230/460	\$2,080.35

NOTE: Amp draw ratings require adequate wire size and full voltage to apply. Full load Amp ratings apply only when full-rated voltage and properly sized wiring is used to supply power to motor.

Baldor Motors – Totally Enclosed Fan Cooled (TEFC)



Totally enclosed for special applications.



- The industry standard
- U.L.-listed
- Any Baldor motors available

Part #	Old No.	HP	Phase	Voltage	RPM	Frame	Model	List Price
8.715-156.0	5-1070	4.0	1PH	230V	1725	56H	35Q988R447G1	\$743.66

NOTE: Any Baldor TEFC motor can be ordered.



Baldor Motors – Totally Enclosed Fan Cooled (TEFC)

Featuring heavy-gauge steel frames, ball bearings, welded base, and “snap-action” starting for reliability. Built to industrial specifications.



Part #	Old No.	HP	RPM	Shaft Dia	Bolt Circle	Frame/C-Face	Full Load Amps	Voltage	List Price
Single-Phase Motors									
8.709-766.0	337351	1.5	1725	5/8"		56	12/6	115/230	\$760.73
8.709-767.0	337352	1.5	1725	5/8"	5-7/8"	56C	12/6	115/230	\$548.55
8.709-769.0	337354	1.5	3450	5/8"	5 7/8"	56C	13.2/6.6	115/230	\$618.93
8.709-772.0	337361	2.0	1725	7/8"	5-7/8"	145TC	8.3	230 only	\$932.54
8.709-773.0	337362	2.0	3450	5/8"		56	17/8.5	115/230	\$611.69
8.709-774.0	337363	2.0	3450	5/8"	5-7/8"	56C	17/8.5	115/230	\$606.51
8.709-776.0	337370	3.0	1725	1-1/8"		184T	13.2	230	\$1,225.44
8.709-778.0	337373	3.0	3450	5/8"		56	12.5	230	\$756.59
8.709-779.0	337374	3.0	3450	5/8"	5-7/8"	56C	13.8-12.5	208-230	\$714.15
8.709-783.0	337379	5.0	1725	1-1/8"		184T	23	230	\$1,292.72
8.709-784.0	337380	5.0	1725	1-1/8"	7-1/4"	184TC	23	230	\$1,342.40
8.709-780.0	337376	5.0	3450	1-1/8"		184T	19.5	230	\$1,224.41
8.709-781.0	337377	5.0	3450	1-1/8"	7-1/4"	184TC	19.5	230	\$1,249.25
8.709-737.0	337280	7.5	1800	1-1/8"	7-1/4"	215C	34.1-30.8	208-230	\$1,863.00
8.709-786.0	337384	7.5	3450	1-3/8"		213T	30-33	208-230	\$2,413.62
8.709-793.0	337393	10.0	1725	1-3/8"		215T	40	230	\$3,012.89
Three-Phase Motors									
8.751-796.0		3.0	1725	1-1/8"	7-1/4"	182TC	9.1-8.2/4.1	208-230/460	\$1,541.12
8.751-319.0		5.0	1725	1-1/8"		184T	14.6-13.2/6.6	208-230/460	\$1,341.36
8.751-318.0		5.0	1725	1-1/8"	7-1/4"	184TC	14.6-13.2/6.6	208-230/460	\$1,527.66
8.751-794.0		7.5	3450	1-1/8"		184T	19-17.2/8.6	208-230/460	\$1,947.87
8.751-799.0		7.5	1725	1-1/8"		213T	22.1-20/10	208-230/460	\$1,950.98
8.751-016.0		10.0	1725	1-3/8"		215T	29-26/13	208-230/460	\$1,458.32
8.751-795.0		10.0	3450	1-3/8"		215T	26.6-24/12	208-230/460	\$2,237.67

NOTE: Some of these motors will require two days from order to shipping.

A.O. Smith – Pressure Washer Motors

Excellent power efficiency. “S” indicates motor has on/off switch.



Part #	Old No.	Motor HP/S*	RPM	Shaft Dia	Bolt Circle	Frame/C-Face	Full Load Amps	Voltage	List Price
8.709-800.0	337413	2.0	3450	5/8"	5-7/8"	56C/56C	17.2/9.2/8.6	115/208/230	\$533.03
8.903-804.0	337414S	2.0	3450	5/8"	5 7/8"	56C/56C	17.2/9.2/8.6	115/208/230	\$742.10
8.709-808.0	337438	6.0	3450	7/8"	5-7/8"	56Y	22.0	208/230	\$770.04
TEFC Motor									
8.709-798.0	337407T	1.5	1750	5/8"	5-7/8"	56C/56C	15.0/7.5	115/230	\$538.20

Small Engine Test Equipment

Spark Tester



- Handy tool allows safe, easy visual inspection of ignition output
- Connects between plug and plug wire
- Totally contained spark
- Engine will run with tester attached
- Neon test light verifies proper ignition

Part #	Old No.	Description	List Price
8.701-680.0	091126	Spark Tester	\$19.98

Compression Tester



- Designed for small engines
- 2-1/2" dial reads up to 300 PSI
- 12" flexible hose to reach spark plug holes
- Adapters for 14mm and 18mm spark plug holes
- Built-in pressure holding/release valves

Part #	Old No.	Description	List Price
8.701-682.0	091133	Comp Tester	\$71.42

Wireless Tachometer



- Terrific service aid for 1-cylinder engines
- Just hold built-in antenna near spark plug
- Excellent for setting GPM on pressure washers; accuracy within 2% of full scale
- Two scales: 0-5,000 RPM or 0-15,000 RPM
- Solid-state electronics
- Requires 9V battery (not included)

Part #	Old No.	Description	List Price
8.701-681.0	091132	Wireless Tach	\$148.01

Couplers Built by Browning or Lovejoy

Listed as individual coupler sections (half) to allow flexibility in design.

For complete coupler select:

Bore size for motor + Bore size for pump + Spider = Complete Coupler



NOTE: Select halves from same series as listed in groups below (e.g. All "090/095", "099/100")

Part #	Old No.	Description	Bore	List Price
090/095 Series: Up to 3 HP Electric or 4 HP Gas				
8.709-620.0	336031	Coupler Half	24mm	\$22.10
8.709-640.0	336050	Coupler Half	5/8" (090)	\$13.87
8.709-634.0	336044	Coupler Half	3/4" (090)	\$14.49
8.709-635.0	336045	Coupler Half	15/16" (090)	\$13.51
8.709-639.0	336049	Buna Spider for 090 (STD)		\$10.61

Part #	Old No.	Description	Bore	List Price
099/100 Series: Up to 5-7 1/2 HP Electric or 5-13 HP Gas				
8.709-626.0	336038	Coupler Half	3/4" (100)	\$43.63
8.709-638.0	336048	Coupler Half	15/16" (099)	\$29.03
8.709-625.0	336037	Coupler Half	20mm(100)	\$59.72
8.709-627.0	336039	Coupler Half	24mm (099)	\$45.18
8.709-628.0	336039A	Coupler Half	24mm (100)	\$64.58
8.709-629.0	336040	Coupler Half	1" (100)	\$43.00
8.709-632.0	336042A	Coupler Half	1-1/8" (100)	\$42.18
8.709-637.0	336047	Coupler Half	1-3/8" (100)	\$43.99
8.709-633.0	336043	Buna Spider for 099/100 (STD)		\$22.46

Pulleys

Fits Interpump, General and Admiral XLS, XDS Series pumps, plus XD3040, XD3047, XD3055 and XD3065.



- Double groove
- 24mm bore
- 2 x A groove

Part #	Old No.	OD	List Price
8.711-115.0	376304	4.0"	\$80.47
8.711-116.0	376305	5.5"	\$60.03
8.711-117.0	376306	6.3"	\$61.69

Reference / Calculation Guide

Conversion Factors

1 inch = 25.4 mm	1 gal H2O = 8.33 lbs	1 gal = 3.79 liter	1 kg = 2.205 lbs
1 cm = 0.394 inch	1 oz = 23.35 gram	1 liter = 0.2642 gal	1 KW = 1.341 HP

Horsepower (HP) Equations

$$HP = \frac{GPM \times PSI}{1460} \quad PSI = \frac{HP \times 1460}{GPM} \quad GPM = \frac{HP \times 1460}{PSI}$$

How fast do I turn my pump to give me a desired GPM?

$$\text{Required RPM} = \frac{(\text{desired GPM} \times \text{Rated RPM})}{\text{Rated GPM}}$$

What size pump pulley do I use to get a certain RPM?

$$\text{Pump Pulley Diameter} = \frac{\text{Motor Pulley Diameter} \times \text{Motor RPM}}{\text{Pump RPM}}$$

Super "Gripnotch" V-Belts



- Full line of belts
- "V"-notched for longer life and better performance

Part #	Old No.	Size	List Price
8.715-669.0		AX26	\$8.07
8.710-727.0	369128A	AX28	\$13.92
8.715-672.0		AX29	\$10.04
8.715-673.0	369130A	AX30	\$10.04
9.804-026.0		AX31	\$10.56
9.803-896.0		AX33	\$10.71
9.802-407.0		AX34	\$10.87
9.803-683.0		AX35	\$11.07
9.802-408.0	369136A	AX36	\$11.39
9.802-409.0		AX37	\$12.01
9.802-410.0	5-602038	AX38	\$12.16
8.715-682.0	5-602041	AX41	\$12.58
9.802-411.0	5-602042	AX42	\$13.09
9.802-412.0	5-604022	BX22	\$12.93
9.802-413.0		BX32	\$12.83
9.802-414.0	369134B	BX34	\$13.03
9.802-415.0	369135B	BX35	\$13.25
9.802-416.0	369136B	BX36	\$14.54
8.715-698.0	369137X	BX37	\$15.16
8.710-745.0	369138B	BX38	\$15.53
9.802-418.0		BX39	\$16.92
8.710-748.0	369140B	BX40	\$17.18
9.802-419.0	369142B	BX42	\$18.68
8.710-754.0	369143B	BX43	\$19.87
9.802-421.0	369144B	BX44	\$20.60
8.710-756.0	369145B	BX45	\$21.06
8.715-706.0		BX46	\$21.68
8.715-708.0		BX48	\$22.51
8.715-710.0		BX51	\$25.20

Pulley Bushings

Split taper "H".

- For use with "H" sheaves, above.



- Split taper, malleable iron
- Keyed to both shaft and hub
- Highest torque carrying capacity

Part #	Old No.	Size	List Price
Motor / Engine Bushings			
9.802-397.0		H x 5/8"	\$14.18
9.803-897.0		H x 3/4"	\$13.66
8.715-633.0		H x 7/8"	\$13.66
9.802-399.0		H x 1"	\$14.18
9.802-400.0		H x 1-1/8"	\$14.11
9.802-401.0		H x 1-3/8"	\$14.49
8.715-638.0	5-511139	H x 1-3/8"-6B, Spline	\$35.91
Pump Bushings			
8.711-118.0	376320	H x 20mm	\$13.04
8.711-119.0	376322	H x 22mm	\$10.92
8.711-121.0	376324	H x 24mm	\$12.68
8.711-122.0	376325	H x 25mm	\$13.92
8.711-123.0	376330	H x 30mm	\$12.06
8.711-124.0	376332	H x 32mm	\$10.09
8.711-125.0	376335	H x 35mm	\$13.92

Pulleys

- High-quality cast-iron pulleys
- Cast design
- All sizes available



AK pulley



2AK pulley



BK pulley



2BK pulley



3TB pulley

Part #	Old No.	Size	OD	List Price
8.715-517.0	5-40102158	AK21*	2.10"	\$13.35
8.715-519.0	5-40102358	AK23*	2.30"	\$13.40
9.802-368.0		AK25*	2.50"	\$13.14
9.804-028.0		AK28*	2.80"	\$17.39
8.715-524.0		AK30H	3.05"	\$16.04
8.715-527.0	5-40103201	AK32H	3.25"	\$26.03
8.715-530.0	5-40103401	AK34H	3.45"	\$26.44
9.803-898.0	5-40103901	AK39H	3.75"	\$32.55
9.802-369.0	5-40107401	AK74H	7.25"	\$51.80
8.715-538.0	5-40108401	AK84H	8.25"	\$48.54
8.715-539.0	5-40108901	AK89H	8.75"	\$57.08
9.803-298.0	5-40203001	2AK30H	3.05"	\$46.06
9.802-371.0	5-40203201	2AK32H	3.25"	\$51.65
9.804-047.0	5-40203401	2AK34H	3.45"	\$26.70
8.715-546.0	5-40204401	2AK44H	4.25"	\$61.84
8.715-548.0	5-40204901	2AK49H	4.75"	\$56.36
8.715-549.0	5-40205101	2AK51H	4.95"	\$67.67
9.802-372.0	5-40205401	2AK54H	5.25"	\$72.61
8.715-555.0	5-40206401	2AK64H	6.25"	\$76.69
9.802-374.0	5-40207401	2AK74H	7.25"	\$80.55
9.802-375.0	5-40208401	2AK84H	8.25"	\$91.39
9.803-548.0	5-40209401	2AK94H	9.25"	\$100.34
8.715-560.0		BK30H	3.30"	\$24.37
9.802-377.0		BK32H	3.35"	\$31.83
9.802-379.0		BK36H	3.75"	\$38.09
8.715-566.0		BK40H	3.95"	\$37.05
8.710-819.0	372586	BK45H	4.25"	\$46.78
8.710-823.0	372596T	BK47H	4.45"	\$51.39
8.710-831.0	372650T	BK52H	4.95"	\$47.45
8.715-567.0	5-40405701	BK57H	5.45"	\$38.40
8.710-837.0	372695	BK60H	5.75"	\$51.39
8.710-841.0	372704T	BK62H	5.95"	\$47.71
8.715-568.0	5-40406501	BK65H	6.25"	\$36.07
8.715-570.0		BK70H	6.75"	\$54.23
8.715-571.0		BK75H	7.25"	\$62.67
9.802-380.0		BK80H	7.75"	\$51.08
8.715-573.0		BK85H	8.25"	\$67.12
8.710-858.0	372799T	BK100H	9.75"	\$92.17
8.715-576.0		2BK32H	3.35"	\$57.80
8.710-811.0	372499T	2BK34H	3.55"	\$61.63
9.802-383.0		2BK36H	3.76"	\$68.57
9.802-384.0		2BK40H	3.95"	\$64.01
9.802-385.0		2BK45H	4.25"	\$73.59
8.715-582.0		2BK47H	4.45"	\$58.48
8.715-583.0	5-40505001	2BK50H	4.75"	\$58.79
9.802-386.0		2BK52H	4.95"	\$75.97
9.802-387.0		2BK60H	5.75"	\$88.80
8.715-588.0		2BK62H	5.95"	\$76.49
9.804-060.0	5-40506501	2BK65H	6.25"	\$75.19
9.802-388.0	5-40506701	2BK67H	6.45"	\$87.04
8.715-591.0		2BK70H	6.75"	\$86.22
9.802-389.0	372774T	2BK80H	7.75"	\$92.53
8.715-593.0	372790T	2BK90H	8.75"	\$87.56
9.802-391.0		2BK100H	9.75"	\$125.24
8.715-598.0	5-406040	2TB40	4.35"	\$67.53
9.802-392.0	5-407034	3TB34	3.75"	\$70.59
9.802-394.0	5-407040	3TB40	4.35"	\$86.68

*x 5/8" Bore



115V / 230V Oil Burners



- .4 to 3 GPH firing rate
- 6-1/4" blower fan 115V and 230V
- 3,450 RPM pump/blower motor
- Solid-state ignition
- Beckett "CleanCut" fuel pump with oil valve
- Air tube 2-3/4"
- UL-recognized

Part #	Old No.	Description	List Price
8.709-325.0	307032	Beckett AFG 115	\$684.14
8.709-326.0	307036	Beckett AFG 230	\$752.45

Beckett Burner Chart

BURNER				MOTOR			BLOWER WHEEL			IGNITOR ASSEMBLY		
Part No	Old No	Description	Becket No	Part No	Old No	Becket No	Part No	Old No	Becket No	Part No	Old No	Becket No
8.709-326.0	307036	AFG / 240V AC	VMG202	8.750-518.0		22825U	9.802-649.0	079517	2999U	8.751-780.0		5199701U
8.709-325.0	307032	AFG / 120V AC	VMG902	9.802-642.0	079602	21805U	9.802-649.0	079517	2999U	9.802-647.0	079669	51771U
8.709-327.0	307059	ADC / 13.5V DC – W/O ICB*	VMG504	9.802-638.0	079613	52145U	9.802-636.0	079518	2999AU	8.751-784.0		5218301U
8.709-328.0	307061	ADC / 13.5V DC – W/ICB	VMG505	9.802-638.0	079613	52145U	9.802-636.0	079518	2999AU	8.751-784.0		5218301U
8.717-071.0	N/A	SM / 120V	H01501	8.701-090.0	079604	2364U	9.803-057.0	079515	2383U	9.803-060.0	079682	51824U
8.717-090.0	N/A	SM / 240V	H01301	8.701-093.0	079609	21344U	9.803-057.0	079515	2383U	8.751-781.0		5199702U

BURNER				FUEL PUMP			SOLENOID W/CORD SET			TUNE UP KIT		
Part No	Old No	Description	Becket No	Part No	Old No	Becket No	Part No	Old No	Becket No	Part No	Old No	Becket No
8.709-326.0	307036	AFG / 240V AC	VMG202	9.802-644.0	079642	2184403U	8.900-082.0	079054X	N/A	8.723-715.0	N/A	578730
8.709-325.0	307032	AFG / 120V AC	VMG902	9.802-645.0	079641	2184405U	8.900-081.0	079053X	N/A	8.723-715.0	N/A	578730
8.709-327.0	307059	ADC / 13.5V DC – W/O ICB*	VMG504	9.802-562.0	079643	2184402U	8.900-080.0	079050X	N/A	8.723-715.0	N/A	578730
8.709-328.0	307061	ADC / 13.5V DC – W/ICB	VMG505	9.802-562.0	079643	2184402U	8.900-080.0	079050X	N/A	8.723-715.0	N/A	578730
8.717-071.0	N/A	SM / 120V	H01501	9.802-645.0	079641	2184405U	8.900-081.0	079053X	N/A	8.723-715.0	N/A	578730
8.717-090.0	N/A	SM / 240V	H01301	9.802-644.0	079642	2184403U	8.900-082.0	079054X	N/A	8.723-715.0	N/A	578730

* Ignition control board

14V ADC Oil Burner



- 14V solid-state ignition
- 1/6 HP
- 3,450 RPM
- 4-1/4" fan
- Beckett "CleanCut" fuel pump with oil valve
- Max rate 2.5 GPH

Part #	Old No.	Description	Oil Valve	Electric Eye	Motor RPM	List Price
8.709-327.0	307059	Beckett 13.5V	Yes	–	3450	\$985.32
8.709-328.0	307061	Beckett 13.5V	Yes	Yes	3450	\$1,032.93

NOTE: Proper operation requires an engine with 16+ Amp alternator and deep-cycle battery on nightly, overnight recharge

Flex Couplings



Part #	Old No.	Beckett Part #	Description	List Price
9.802-648.0	079520	2454	5/16 "A"– (AFG)	\$4.62
9.803-058.0	079522	2433	5/16 "S"– (SF/SM)	\$4.81
9.802-637.0	079524	2140501U	1V DC ADC	\$8.49

Genisys™ Controller and Contractor Tool



Advanced burner control, 120V AC primary safety control for residential and light commercial oil burners.

Part #	Description	List Price
8.751-335.0	Genisys Controller	\$191.48
8.726-018.0	Genisys Contractor Tool	\$137.66

Beckett Misc. Parts

Part #	Old No.	Beckett Part #	Description	List Price
9.802-651.0			Burner Gasket AFG 120V	\$4.35
8.701-059.0		578726 SDC	Electrode Insul Assy	\$16.56
8.701-056.0	079530	149	Electrode Clamps (ALL)	\$1.60
8.701-063.0	079542	5432	Flange, w/ Gasket (ALL)	\$15.37
8.723-912.0	079543	5850	Flange, Split Unl A&S	\$22.36
8.701-070.0	079560	3616	Gasket, Universal AMF	\$3.61
9.802-653.0	079562	3416	Gasket, Unit Mtg	\$2.58
9.802-671.0	079592	5877	Burner Housing AFG/ADC	\$181.13
8.701-085.0	079595	5717 (51400)	Knurled Nut Kit ADC	\$7.61
8.701-134.0	079677	51304	Transf Mtg Gasket AFG	\$4.45
8.701-132.0	079674	31404	Transformer Clip	\$1.45
9.802-676.0	079654	7006U	Cadcell Flame det	\$19.41
8.701-137.0	079684	7556A0000	Primary Control, 14V DC	\$284.63
8.701-133.0	079675	3245	Transformer Spring	\$4.30
8.701-106.0	079629	AF90	Air Tube w/o Head	\$68.41
8.701-074.0	079573	5151501	Air Band (3 x 92 AFG)	\$4.71

Electrode/Insulator Assembly



Part #	Old No.	Beckett Part #	Description	List Price
9.802-668.0	079534	5780	Std to 9" AFG, SM, SF	\$18.72
8.717-978.0		578728	ADC	\$14.71
9.802-669.0			Electrode w/ Contact, PR	\$14.96
9.802-670.0			Electrode Kit	\$15.60

Legacy Fire-Rite Burners

Legacy Fire-Rite oil burners are a leader in performance, reliability, and energy efficiency. With industry exclusive features that are easy to install and provide a durable, maintenance-free package. Designed for the harsh environment of the pressure washer industry, these burners are built to provide years of trouble-free service.



- 0.75 to 3.0 GPH
- 56,000 to 420,000 BTU/hr input
- Exceptional performance even at low fire
- Easy to service due to overall simple ease of making adjustments and overall design
- Sight glass for viewing spark, ignition, and fan
- Solid State, high output ignitors for better ignition
- Power and ignition indicator lights
- Die cast aluminum fan housing with slide-in guide for forged brass gun assembly
- Danfoss Fuel pumps
- Forged brass gun assembly with self-aligning electrodes for reliable ignition
- Water-tight electrical box with numbered terminal strip and wiring diagram for quick and easy installation
- Fuel options include No. 1 or 2 heating oil (ASTM 0396)
- ETL Listed to UL and CSA Safety Standards
- Patent US D665,901 S

Part No	Size	Motor/Ignitor Voltage	Motor	Solenoid Voltage	Air Cone Size	Firing Rate Min (GPH)	Firing Rate Max (GPH)	Tube Length	List Price
8.922-847.0	S	12V	3450 RPM, Continuous-Duty, NEMA M-flange, Danfoss Fuel Pumps	12-24V	F22	0.75	2.50	3"	\$730.71
8.922-848.0	S	12V	3450 RPM, Continuous-Duty, NEMA M-flange, Danfoss Fuel Pumps	12-24V	F22	0.75	2.50	1"	\$1,032.93
8.922-849.0	S	230V	3450 RPM, Continuous-Duty, NEMA M-flange, Danfoss Fuel Pumps	120V	F22	0.75	2.50	1"	\$692.42
8.922-850.0	S	120V	3450 RPM, Continuous-Duty, NEMA M-flange, Danfoss Fuel Pumps	120V	F22	0.75	2.50	1"	\$737.96
8.922-869.0	S	120V	3450 RPM, Continuous-Duty, NEMA M-flange, Danfoss Fuel Pumps	120V	F22	0.75	2.50	3"	\$684.14
8.922-870.0	S	120V	3450 RPM, Continuous-Duty, NEMA M-flange, Danfoss Fuel Pumps	12-24V	F22	0.75	2.50	1"	\$659.30
8.922-871.0	S	230V	3450 RPM, Continuous-Duty, NEMA M-flange, Danfoss Fuel Pumps	230V	F22	0.75	2.50	3"	\$752.45
8.922-873.0	S	230V	3450 RPM, Continuous-Duty, NEMA M-flange, Danfoss Fuel Pumps	230V	F22	0.75	2.50	1"	\$769.01
8.922-874.0	S	12V	3450 RPM, Continuous-Duty, NEMA M-flange, Danfoss Fuel Pumps	12-24V	F12	0.75	2.50	1"	\$842.49
8.922-876.0	S	120V	3450 RPM, Continuous-Duty, NEMA M-flange, Danfoss Fuel Pumps	120V	F6	0.75	2.50	1"	\$729.68
8.922-877.0	S	120V	3450 RPM, Continuous-Duty, NEMA M-flange, Danfoss Fuel Pumps	120V	F4	0.75	2.50	1"	\$755.55
8.922-878.0	S	120V	3450 RPM, Continuous-Duty, NEMA M-flange, Danfoss Fuel Pumps	120V	F4	0.75	2.50	3"	\$626.18
8.922-879.0	S	12V	3450 RPM, Continuous-Duty, NEMA M-flange, Danfoss Fuel Pumps	12-24V	F12	0.75	2.50	3"	\$986.36
8.922-880.0	S	120V	3450 RPM, Continuous-Duty, NEMA M-flange, Danfoss Fuel Pumps	120V	F12	0.75	2.50	3"	\$673.79
8.922-881.0	S	120V	3450 RPM, Continuous-Duty, NEMA M-flange, Danfoss Fuel Pumps	12-24V	F12	0.75	2.50	3"	\$698.63
8.922-882.0	S	120V	3450 RPM, Continuous-Duty, NEMA M-flange, Danfoss Fuel Pumps	120V	F6	0.75	2.50	3"	\$830.07
8.922-872.0	ML	230V	3450 RPM, Continuous-Duty, NEMA M-flange, Danfoss Fuel Pumps	24V	F22	1.00	5.00	1"	\$805.23
8.922-875.0	ML	120V	3450 RPM, Continuous-Duty, NEMA M-flange, Danfoss Fuel Pumps	24V	F12	1.00	5.00	3"	\$821.79

Dimensions in inches for all models

Model	A	B	C	D	E	F
S	12.25	3.0	5.75	13.0	3.0	6.0
ML	15.00	3.0	6.0	13.0	5.0	7.5

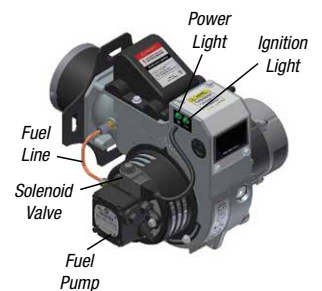
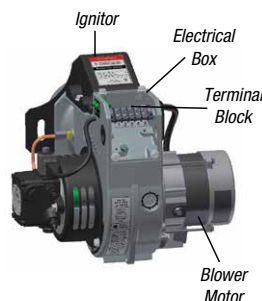
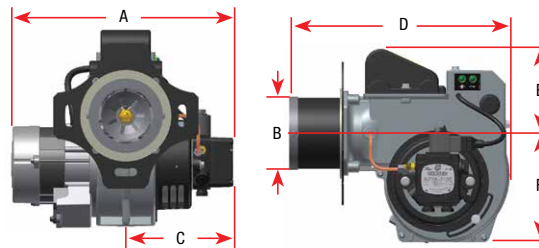

Oil Burners



115V / 230V

- .75 to 3 GPH firing rates
- Solid-state ignition (low Amp)
- High-volume 6-1/4" blower on 220V unit, 5-3/16" blower on 110V unit
- 3,450 RPM pump/blower motor
- "A"-type Suntec fuel pump
- 3-3/4" air tube with adjustable flange for maximum versatility
- UL-recognized



12V

- 12V solid-state ignitor
- 3,450 RPM fuel pump
- .5 to 2.75 GPH capacity with oil valve



Part #	Old No.	Description	List Price
8.709-317.0	307000	115V AC Burner w/ Oil Valve	\$904.59
8.709-318.0	307003	230V AC Burner w/ Oil Valve	\$924.94
8.709-319.0*	307007	12V DC Burner w/ Oil Valve	\$971.84

*Proper operation requires an engine with 16+ Amp alternator and deep-cycle battery on nightly, overnight recharge

Wayne Burner Chart

Part #	Description	Ignitor	Transformer	Motor	Blower Wheel	Fuel Pump	Solenoid Valve	Electrode Assembly	Tune Up Kit
8.709-317.0	Wayne 115V	8.700-802.0 079111	8.700-804.0 079115	8.701-095.0 079612	8.700-730.0 079005	8.700-749.0 079030	8.700-779.0 079062	8.700-770.0 079052	8.700-774.0 079056
8.709-318.0	Wayne 220V	N/A N/A	8.700-809.0 079123	8.701-094.0 079611	8.700-731.0 079006	8.700-749.0 079030	8.700-780.0 079063	8.700-770.0 079052	8.700-774.0 079056
8.709-319.0	Wayne 12V	8.700-807.0 079120 Includes	N/A N/A	8.700-739.0-FASCO 079021 8.750-715.0-MET to FASCO 079021X	8.700-727.0- (079003)FASCO 2.44" W x 2.53" T 5/16" shaft 8.700-728.0 (079003A) MET 3.44" W x 4.25" T 1/2" shaft	8.700-749.0 079030	8.700-782.0 079064	8.700-770.0 079052	8.700-774.0 079056 with 8.700-721.0 coupling for converting from MET to FASCO

NOTE: 8.700-721.0 – Coupling for 8.700-740.0 FASCO motor used on MET to FASCO converted burner
 8.700-720.0 – Adaptor Bushing to allow MET blower wheel to work with FASCO motor
 8.700-740.0 – Conversion Kit — Use MET to FASCO conversion kit if 12V burner motor cannot be identified. The kit contains the following parts: 8.700-739.0 Motor; 8.700-720.0 Adaptor bushing;
 8.700-682.0 Adaptor Plate; 8.700-721.0 Coupling; 8.700-691.0 Screws (2); 8.700-104.0 Nuts

Blower Wheel



Part #	Old No.	Wayne Part #	Description	Shaft Size	List Price
8.700-730.0	079005	20288/SER	5-3/16" x 3-7/16"	1/2"	\$29.81
8.700-731.0	079006	21854/SER	6-1/4" x 4-3/16"	1/2"	\$34.67
8.700-726.0	078999	20673	4-1/4" x 3-1/8"	1/2"	\$27.01
8.700-727.0	079003	21427/SER3	12V (Fasco)	5/16"	\$47.71
8.700-728.0	079003A	21427	(MET)	1/2"	\$35.24

Common Parts – Beckett & Wayne



Oil Line



Brass Elbow

Part #	Old No.	Description	List Price
8.701-054.0	079526	Oil Line, 6.5", Copper	\$5.07
9.802-667.0	079058	Oil Line, 8", Copper	\$4.61
8.701-053.0	079525	Oil Line, 9.5", Copper	\$5.95
8.700-784.0	079066	Brass 90° Elbow 1/8" flare, 1/8" MPT	\$6.68
8.700-785.0	079067	Brass 90° Elbow 3/16" flare, 1/8" MPT	\$5.33
8.700-738.0	079020	Oil Pressure Gauge 0-200 PSI	\$11.54
8.700-768.0	079051	(28737-1) Nozzle Adapter	\$9.57
8.705-063.0	140150	Straight Thru Double Nipple 1/8" x 1/8"	\$2.74

Wayne Burner Parts



Part #	Old No.	Wayne Part #	Description	List Price
8.700-774.0	079056	31156	Wayne Burner Tune-up Kit	\$46.71
8.700-770.0	079052	14733-001 14734-002	Electrode Assembly (Pair) with Buss Bars – G shape	\$32.60
8.700-743.0	079024	12945	Buss Bar – G shape	\$8.49
8.700-754.0	079034	14344	Burner Gasket	\$4.71
8.700-692.0	078785	12484	Universal Gasket	\$4.33
8.700-735.0	079014	4725	Burner Housing (E-Series)	\$158.36
8.700-736.0	079016	2689	Burner Flange "F"	\$71.16
8.700-776.0	079059	13279	Flex Coupler A Fuel Unit	\$9.32
8.700-777.0	079060		Coupler End (J Pump 7/16")	\$2.28
8.700-733.0	079010	13360	Trans Clip Screw	\$2.87
8.700-734.0	079011	13038	Trans Clip	\$7.30
8.700-729.0	079004	2668	Outer Air Band (8 Hole)	\$11.39
8.700-732.0	079007	2669	Inner Air Band (8 Hole)	\$11.07
8.700-714.0	078979	31702-014	Gun Assy, F/307007	\$145.94
8.700-680.0	078752		Nzl Adapter w/legs MSR/DC	\$36.79

Burner Motors



48M
5.75" Dia.



48N
7.25" Dia.

Part #	Old No.	Capacitor	RPM	HP	Flange	Voltage	Wayne / Beckett	List Price
9.802-642.0	079602	Y	3450	1/7	48M	115V	20627 / 21805U	\$131.45
8.750-518.0		Y	2850/3450	1/7	48M	220V	N/A / N/A	\$191.58
8.700-739.0	079021		4500	1/5	48M	12V DC	21993-005 / N/A	\$172.85
9.802-638.0	079613		3450	1/7	48M	13.5V	N/A / 52145U	\$175.10
8.701-090.0	079604		3450	1/4	48N	115V	N/A / 2364U	\$193.55
8.701-091.0	079605		3450	1/4	48N	12V	N/A / 52146U	\$408.83
8.701-093.0	079609	Y	3450	1/4	48N	115/240V	N/A / 21344	\$229.77
8.701-094.0	079611		3450	1/5	48N	240V	21328 / 21173U	\$176.99
8.701-095.0	079612		3450	1/5	48N	115V	20554 / 2900U	\$178.63
8.700-740.0	079021X	Kit, 12V DC/MET to Fasco						\$207.00
Universal								
8.700-741.0	079022		3450	1/7	48M	110-60 Hz		\$251.51
8.700-744.0	079025		3450	1/5	48N	110/240V	Capacitor Start	\$301.79

Beckett Tune-Up Kit

Fits all Beckett Burners with 3" or 3-5/8" air tube.



- Kit contains:
- Four Beckett electrodes
 - Two couplings
 - One fuel line

Part #	Description	List Price
8.723-715.0	Beckett Burner Tune-up Kit	\$34.20



Fuel Pumps



- Use with single- or dual-line systems
- Pressure adjustment valve

Part #	Old No.	Suntec PN	GPH	RPM	Rotation	List Price
Standard Pumps						
8.700-749.0	079030	A2VA7116	3	3450	RH	\$104.03
8.700-789.0		A2VC7118	3	3450	LH	\$171.81
8.700-756.0	079031	A1YA7912	7	1725	RH	\$151.11
8.700-757.0	079037	A2YA7916	7	3450	RH	\$158.36
8.700-748.0	079028	A2RA7710			RH	\$127.31
Pumps with Solenoid						
8.700-758.0	079038	A2VA3006-N221R w/12V	4	3450	RH	\$134.93
8.700-759.0	079038-110	A2VA3006-N621L w/110V	3	3450	RH	\$133.52
8.700-760.0	079038-220	A2VA3006-N721RS w/220V	3	3450	RH	\$163.75
Pump Replacement Parts						
8.700-764.0	079044	3715732 (A2VA 7116)			Pump Fuel Screen	\$7.50
8.700-772.0	079055	3715744 (A2AVA 7916)			Pump Fuel Screen	\$7.66
8.700-765.0	079045	3779801			Gasket Cover	\$0.88

Blower Wheels



Part #	Description	Shaft Size	List Price
9.803-057.0	6-1/4" D x 3-7/16" W	1/2" SF-SM	\$29.55
9.802-649.0	4-1/4" D x 2-1/2" W	1/2" AFG	\$19.77
9.802-636.0	4-1/4" D x 2-7/16" W	5/16" ADC	\$26.44



CleanCut Fuel Pump

Simple design provides faster cleaning, more reliable cut-offs, and cut-ons. Cleaner operation — less soot. More reliable — fewer moving parts. Reduced motor load in start-up. Higher capacity — 4 GPH at 100 PSI.



- 100-200 PSI — factory set 100 PSI
- Inlet pressure 10 PSI
- Rated speed 3,600 RPM
- Includes built-in solenoid w/ cord set

Part #	Old No.	Description	List Price
9.802-645.0	079641	110V	\$126.69
9.802-644.0	079642	220V	\$131.84
9.802-562.0	079643	12V	\$140.37
9.802-646.0	079690	Valve Stem Kit (21877U)	\$13.25



Fuel Conditioner and Soot Remover

Red Devil eliminates soot build-up.



- Easy to use — just add to burner fuel
- Keeps burner at top efficiency
- 1 oz. per 10 gallons

Part #	Old No.	Description	List Price
8.704-625.0	112057	Pint (16 oz)	\$13.34
8.704-626.0	112059	Quart	\$21.63
8.719-158.0	9-4007	Soot-O-Magic Stick	\$5.72

Burner Transformers



- 10,000V spark
- 2.2 Amp @ 120V
- 8.5 lbs
- Traditional copper-wire wound

Part #	Old No.	Beckett Part #	Mounting	Volt	List Price
9.802-661.0*	079668	51343U	AFG	240V	\$133.12
8.701-125.0*	079662	21376U	S-SF-SR-SM	120V	\$143.87
9.803-055.0*	079665	21176U	SM	240V	\$132.48

* Bottom mount

Burner Ignitors



- Solid-state technology
- 14,000V spark
- Only .35 Amp @ 110V
- 1.7 lbs

Part #	Old No.	Beckett Part #	Mounting	Volt	List Price
9.802-647.0	079669	51771U	AFG/Lo Amp	120V	\$96.31
8.701-149.0	079707	517780	SDCw/ Con BD	12V DC	\$251.51
9.803-060.0	079682	51824U	SM/SF	120V	\$101.19
8.701-140.0	079687	51779U	SDCw/o CB	12V DC	\$211.14

*Complete with timer

Base Plates for Ignitors

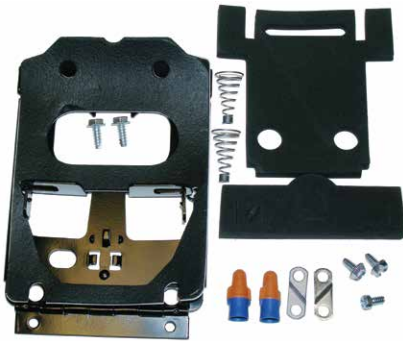

Part #	Old No.	Description	List Price
8.701-116.0	079644	A, Trans/Ign	\$15.78
8.701-117.0	079645	S, Trans/Ign	\$25.25
8.701-118.0	079646	E, Trans/Ign	\$24.94
8.701-119.0	079647	M, Trans/Ign	\$25.36

Nozzle Accessories



Part #	Old No.	Description	List Price
8.700-849.0	079221	Nozzle Tray (Metal) (Open Top, 55-Compartment, Plastic)	\$60.10

Burner Transformers



- 10,000V spark
- 2.2 Amp @ 120V
- 8.5 lbs
- FranceFormer

Part #	Old No.	Wayne Part #	Mounting	Volt	List Price
8.700-804.0	079115	23101/E	Side/EH-EHA	120V	\$128.75
8.700-806.0	079117	23101/M	Back/M-MSR	120V	\$136.62
8.700-809.0	079123	23103/E	Side/EH-EH	230V	\$142.14
8.700-810.0	079124	23103/M	Back/10KVA	240V	\$153.18

Burner Ignitors



- Solid-state technology
- 14,000V spark
- Only .35 Amp @ 120V
- 1.7 lbs

Part #	Old No.	Wayne Part #	Mounting	Volt	List Price
8.700-802.0	079111	101122/001	Side/EH-EHA, France	120V	\$122.57
8.700-803.0	079113	101121/001	Back/M-MSR, France	120V	\$128.75
8.700-800.0	079107	31813-002	Side/EH-EHA, Allanson	220V	\$185.27
8.700-801.0	079109	31812-002	Back/M-MSR	220V	\$188.37
8.700-807.0	079120	31812-003	Rear Mount, Carlon	12V	\$206.03
8.700-820.0	079152	31813003	Side Mount(E)	12V	\$232.88

12V DC KIP Fuel Solenoid Valve



- Brass body
- 12V DC coil
- 1/8" FPT I/O ports
- Conduit connector
- 5/64" orifice = 6 watt

Part #	Old No.	Description	List Price
8.701-120.0	079652	Fuel Solenoid Valve	\$83.58

Smoke Tester – Diagnostic Tool

The smoke tester gives you the ability to measure smoke (soot) density and adjust air flow and fuel pressure to optimize burner performance.



A properly tuned burner:

- Heats water more efficiently
- Doesn't build up soot in the coil
- Doesn't pollute the air
- Keeps your customers happy
- A tool that should be used by every serviceman in the industry

Part #	Old No.	Description	List Price
8.712-507.0	449020	Smoke Tester	\$389.16
8.712-506.0	449019	Filter Paper Refill*	\$79.38

*40 sheet (10 tests per sheet)

Oil Solenoid Valve



- Unitized mounting on Suntec fuel pumps
- 1/8" FPT inlet
- 300 PSI
- Uses standard Suntec coil

Part #	Old No.	Description	List Price
8.700-779.0	079062	110V Oil Valve – R642	\$49.65
8.700-780.0	079063	220V Oil Valve – R753	\$52.07
8.700-782.0	079064	12/24V Oil Valve – R261	\$56.96
8.700-811.0	079125	Flow-Thru Connector Bolt	\$9.78
8.700-812.0	079126	Aluminum Seal Washer	\$1.24
8.900-081.0	079053X	110V Coil w/ Cord Set	\$15.94
8.900-082.0	079054X	230V Coil w/ Cord Set	\$21.74
8.900-080.0	079050X	12/24 Coil w/ Cord Set	\$23.65
9.802-640.0	079096	115V Coil w/o Cord Set	\$16.77
9.802-641.0	079097	230V Coil w/o Cord Set	\$17.23
8.700-794.0	079098	12/24V DC Coil w/o Cord Set	\$17.28
8.700-795.0	079099	Cord Set Only	\$6.21
8.900-079.0	079047	8mm Nut for Old Style Coil	\$5.69

Gas Burner Rings – N/G or L/P Gas Jets

The standard for gas-fired pressure washers. Impinged jet burner rings offer the most efficient utilization of gas for heating water.



Gas Burner Ring

Part #	Old No.	Model No.	Jets Req'd	1000 BTUH	List Price
Gas Burner Rings Only					
8.710-203.0	347502	Z-21	20	100-200	\$284.63
8.710-204.0	347504	X-11	32	160-320	\$305.33
8.710-207.0	347506	X-44	44	220-440	\$138.69
8.710-210.0	347508	X-66	66	330-660	\$1,024.65
8.904-003.0	347510	X-88	88	440-880	\$1,374.48



Gas Jets

Part #	Old No.	Drill Size	Orifice Size	Use	List Price
Gas Jets for Burner Rings* (above)					
8.710-215.0	347552	#52	(.0635)	NG	\$3.47
8.710-216.0	347554	#54	(.055)	NG	\$3.47
8.710-217.0	347562	#62	(.038)	LP	\$3.47
8.710-218.0	347565	#65	(.035)	LP	\$3.47
8.710-219.0	347566	#66	(.033)	LP	\$3.45
9.802-684.0		#69	(.029)	LP	\$10.19
8.710-214.0	347549	Blank (Must Be Drilled)			\$3.16

*Due to freight damage on assembled rings/jets, separately order correct number and size of jets for each burner ring.

Honeywell Gas Valves



9.803-615.0

Natural Gas – Small Millivolt Valve

Part #	Old No.	Description	List Price
9.803-615.0	7-7000CH1	Natural Gas Millivolt Valve, 3/4" NPT	\$243.23
9.803-617.0	7-7CH1	Pilot for Piezo Ignitor	\$34.88
9.803-611.0	7-70360	47" Powerpile	\$89.57
9.803-614.0	7-70232	LP Conversion Kit (NG to LP)	\$15.37
8.718-116.0	7-7078	NG Conversion Kit (LP to NG)	\$19.54



9.803-616.0

Natural Gas – Small Electronic Ignition Valve

Part #	Old No.	Description	List Price
9.803-616.0	7-700021	Natural Gas Electronic Ignition Valve, 24V, 3/4" NPT	\$151.41
9.803-618.0	7-702320	LP Conversion Kit (NG to LP)	\$14.28
8.718-112.0	7-70700	NG Conversion Kit (LP to NG)	\$12.51



8.718-048.0



9.803-612.0

Natural Gas/LP – Large Electronic Ignition Valve

Part #	Old No.	Description	List Price
8.718-050.0	7-70003	Natural Gas Electronic Ignition Valve, 24V, 1" NPT (no LP conversion kit)	\$366.68
8.718-048.0	7-700022	LP Gas Electronic Ignition Valve, 24V, 1" NPT (no NG conversion kit)	\$399.51
9.803-612.0	2-990581	Solenoid Pilot	\$151.11

See Electronic Ignition Parts below.



9.803-613.0



9.803-610.0

Electronic Ignition

Part #	Old No.	Description	List Price
9.803-613.0	7-701510	Electronic Ignition Controller Black 90 sec TFI	\$144.20
9.803-610.0	7-702371	Pilot, Electronic Ignition	\$36.77
9.803-562.0	6-01352	48" Ignition Cable	\$29.92
8.905-681.0	6-01353	60" Ignition Cable	\$35.95
8.930-332.0		69" Ignition Cable	\$38.86

Delavan Fuel Nozzles



List Price

\$7.81

Part #	Old No.	GPH
8.701-018.0	079477	2.00 x 60°W
8.701-021.0	079480	1.50 x 80°W
8.701-020.0	079479	1.65 x 80°W
8.701-023.0	079481	1.75 x 80°W
8.701-024.0	079482	2.00 x 80°W
8.701-025.0	079483	2.25 x 80°W

Part #	Old No.	GPH
8.701-026.0	079484	2.50 x 80°W
8.701-028.0	079486	2.75 x 80°W
8.701-029.0	079487	3.00 x 80°W
8.701-031.0	079490	4.00 x 80°W
8.701-039.0	079505	1.65 x 90°W
8.701-032.0	079492	2.00 x 90°W

NOTE: The above "W" nozzles are stocked — all sizes are available.

Select proper size for maximum burner efficiency.

GPH	60° A Hollow Part No	60° A Hollow Old No	60° B Solid Part No	60° B Solid Old No	70° A Hollow Part No	70° A Hollow Old No	70° B Solid Part No	70° B Solid Old No	80° A Hollow Part No	80° A Hollow Old No	80° B Solid Part No	80° B Solid Old No	90° A Hollow Part No	90° A Hollow Old No	90° B Solid Part No	90° B Solid Old No
.50	8.700-850.0	079225	8.700-868.0	079250	8.700-887.0	079275	-	-	8.700-911.0	079325	-	-	-	-	8.700-981.0	079400
.60	-	-	-	-	-	-	-	-	8.700-912.0	079326	8.700-932.0	079351	8.700-960.0	079376	-	-
.65	8.700-852.0	079227	-	-	-	-	-	-	8.700-913.0	079327	8.700-933.0	079352	8.700-961.0	079377	-	-
.75	-	-	8.700-870.0	079253	-	-	8.700-896.0	079303	8.700-914.0	079328	8.700-934.0	079353	8.700-962.0	079378	8.700-982.0	079403
.85	8.700-853.0	079229	8.700-871.0	079254	-	-	-	-	8.700-915.0	079329	8.700-935.0	079354	-	-	8.700-983.0	079404
.90	8.700-854.0	079230	8.700-872.0	079255	-	-	-	-	8.717-333.0	900450	8.700-936.0	079355	8.700-963.0	079380	-	-
1.00	8.700-855.0	079231	8.700-873.0	079256	8.717-276.0	799516	8.700-897.0	079306	8.700-916.0	079331	8.700-937.0	079356	9.802-583.0	900451	8.700-984.0	079406
1.10	8.700-856.0	079232	8.700-874.0	079257	-	-	-	-	8.700-917.0	079332	8.700-938.0	079357	8.717-332.0	900449	8.700-985.0	079407
1.20	8.700-857.0	079233	8.700-875.0	079258	8.700-890.0	079283	-	-	8.700-918.0	079333	8.700-939.0	079358	-	-	-	-
1.25	8.700-858.0	079234	8.700-876.0	079259	-	-	8.700-899.0	079309	8.700-919.0	079334	8.717-350.0	900766	8.700-966.0	079384	8.700-986.0	079409
1.35	8.700-859.0	079235	8.700-877.0	079260	-	-	8.700-900.0	079310	9.802-584.0	900452	8.717-358.0	900784	8.700-967.0	079385	8.700-987.0	079410
1.50	8.717-328.0	900367	8.700-878.0	079261	8.717-278.0	799518	-	-	8.700-921.0	079336	8.717-351.0	900767	9.802-585.0	900650	8.700-988.0	079411
1.65	8.700-861.0	079237	8.700-879.0	079262	-	-	-	-	8.700-922.0	079337	8.700-943.0	900768	8.700-969.0	079387	8.700-989.0	079412
1.75	8.700-862.0	079238	8.700-880.0	079263	8.700-892.0	079288	8.700-903.0	079313	8.717-329.0	079338	8.717-352.0	900769	8.700-970.0	079388	9.802-575.0	079413
2.00	8.717-327.0	900270	-	-	-	-	8.700-904.0	079314	8.700-924.0	079339	8.717-353.0	900771	8.700-971.0	079389	9.802-576.0	079414
2.25	8.700-864.0	079240	8.700-881.0	079265	-	-	8.700-905.0	079315	8.700-925.0	079340	8.700-946.0	900773	8.700-972.0	079390	9.802-577.0	079415
2.50	8.700-865.0	079241	8.700-882.0	079266	8.700-893.0	079291	-	-	8.700-926.0	079341	8.700-947.0	900775	8.700-973.0	079391	9.802-586.0	079416
2.75	8.700-866.0	079242	8.700-883.0	079267	-	-	-	-	8.700-927.0	079342	8.717-330.0	900375	8.700-974.0	079392	8.700-994.0	079417
3.00	-	-	-	-	8.700-894.0	079293	-	-	8.700-928.0	079343	8.717-354.0	900777	8.700-975.0	079393	8.700-995.0	079418
3.25	8.700-867.0	079244	-	-	8.700-895.0	079294	-	-	-	-	8.700-950.0	079369	8.717-336.0	900454	8.700-996.0	079419
3.50	-	-	8.700-884.0	079270	-	-	-	-	8.700-929.0	079345	8.700-951.0	-	8.700-977.0	079395	8.700-997.0	079420
4.00	-	-	-	-	-	-	-	-	8.700-930.0	079346	8.700-952.0	079371	8.700-978.0	900456	8.700-998.0	079421
4.50	-	-	-	-	-	-	-	-	-	-	8.717-367.0	-	-	-	-	-
5.00	-	-	-	-	-	-	-	-	-	-	8.717-357.0	900783	8.700-979.0	079398	-	-
6.00	-	-	-	-	-	-	-	-	-	-	8.700-956.0	079374	-	-	8.701-000.0	079425
6.50	-	-	-	-	-	-	-	-	-	-	8.700-953.0	079372	-	-	-	-
7.00	-	-	-	-	-	-	-	-	-	-	-	-	-	-	-	-
8.00	-	-	-	-	-	-	8.700-910.0	079324	-	-	-	-	-	-	-	-

"Snap" Fuel Nozzle Check Valve

Spring-loaded "snap" check valve replaces filter element on fuel nozzle. Valve opens when fuel pump pressure reaches 130 PSI and "snaps" shut when fuel pressure drops below 130 PSI. Stops "smokey" burners at start-up and eliminates "shutdown" after burn.



- Reduces nozzle fouling caused by residual fuel in orifice
- Easy field installation in standard fuel nozzles
- Reduces soot build-up in coil

Part #	Old No.	Description	PSI	List Price
8.900-083.0	079210	Snap Fuel Valve	100	\$28.67
8.900-084.0	079211	Snap Fuel Valve	130	\$25.44
8.700-845.0	079215	Snap Check Valve, (5/pk)	130	\$117.99
8.700-844.0	079214	Snap Check Valve, (5/pk)	100	\$117.99

1" Gas Valves by Robert Shaw

Universal type for new equipment or replacement.



- Manual gas cock
- Auto-pilot safety valve
- Wiring and hardware included
- Pilot gas filter
- 600,000 BTU LP gas
720,000 BTU natural gas
- 1" inlet/outlet

*Kit is for 8.710-174.0 and includes: gas valve, flame sensor, electrode pilot relight and harness

Part #	Old No.	Description	List Price
8.710-178.0	347406	240V AC/NG, Standing Pilot	\$876.33
8.710-179.0	347407	24V AC/NG, Standing Pilot	\$722.61
8.710-174.0	347403	24V AC/NG, Electronic Ignition	\$635.51
8.710-181.0	347409	700 MV, Natural Gas	\$464.38
8.710-163.0*	347379	24V Retrofit Kit (NG) 720,000 BTU	\$789.71
9.802-677.0		Ignitor	\$124.63

LP Conversion Kit below

LP Conversion Kit for Robert Shaw

Convert NG to LP.

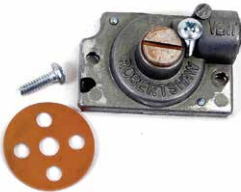

Part #	Old No.	Description	List Price
8.710-187.0	347421	1" LP Conversion Kit	\$25.98
8.710-164.0	347380	LP Orifice	\$14.48

Gas Valves – LP or Natural

Universal-type for building new systems or field replacement.
750 MV, 24V or 120V controls by White-Rodgers.



- 335,000 BTU max
- 3/4" inlet/outlet
- All adjustments and wiring connections on top of valve
- Automatic outlet pressure regulator
- A.G.A.-design certified, C.G.A.-certified

Part #	Old No.	Description	List Price
8.710-172.0	347400	Gas Valve 24V (1)	\$198.79
8.710-182.0	347410	Gas Valve 120V (2)	\$277.07
8.710-183.0	347412	Gas Valve 750 MV (1)	\$260.59
8.750-110.0		3/4" NG to LP Conversion Kit	\$20.86
8.750-109.0		3/4" LP to NG Conversion Kit	\$19.41

(1) Includes two 3/4" x 1/2" all-thread plated bushings and valve instructions.

(2) Includes L.P. Kit, two 3/4" x 1/2" and one 1/2" x 3/8" all-thread plated bushings and all instructions.

White-Rodgers Repair Parts

Part #	Old No.	Description	List Price
8.710-184.0	347416	24V Cycle Pilot Control (347425)	\$169.74
8.710-197.0	347440	120V Cycle Pilot Control	\$164.57
8.710-198.0	347446	Gas Ignition Electrode (24" Lead)	\$110.75

Gas Valve Accessory Components

Use with both 3/4" and 1" models on this page.



8.710-190.0

Part #	Old No.	Description	List Price
8.710-190.0	347430	750 MV Generator	\$65.00
8.710-191.0	347431	P110T Pilot Burner (Natural gas)	\$54.46
8.718-092.0	347436	Thermo Couple (w/ 24") Cap Tube	\$14.18
8.710-196.0	347438	Thermo Couple (w/ 36") Cap Tube	\$14.23
9.802-686.0		Thermopile, VNG, 44	\$47.43

Insulation and Rigid Disc/Donuts

Refractory-grade ceramic kaowool formed; retains heat inside coil for better fuel efficiency and paint protection.



Part #	Old No.	Description	Thickness	Width	Length	List Price
"Rigid Formed" Donut and Discs						
8.704-807.0	122253	Donut	.88"	18"	6"/4.4"	\$45.26
8.704-810.0	122258	Donut	.88"	16"	6"/4.4"	\$45.18
8.717-474.0		Donut		24"		\$72.97
8.704-808.0	122254	Disc	1/2"	18"		\$24.05
8.704-809.0	122257	Disc	1/2"	16"		\$22.19
8.717-475.0		Disc		24"		\$63.65

Insulation Blanket

8.901-288.0	122204	Coil Wrap	1"	24"	4'	\$40.37
8.901-289.0	122205	Coil Wrap	1"	24"	5'	\$47.82
8.704-800.0	122206	Coil Wrap	1"	24"	6'	\$50.04
8.704-802.0	122222	Full Roll	1/2"	24"	37.5'	\$172.85
8.704-805.0	122225	Full Roll	1"	24"	25'	\$158.62

Legacy Flow Switch

Spring-return float allows full mounting versatility.



- 4050 PSI
- 3500-rated pressure
- Horizontal or vertical mount
- Forged-brass body
- 48" wire length
- 2-wire reed
- 3/8" MPT inlet/outlet
- 8 GPM
- 190°F
- One Amp switch
- Solenoid control

Part #	Old No.	Description	List Price
8.712-246.0	410307P	Flow Switch	\$61.70
9.803-266.0	109672	Reed Switch Only	\$34.93

Flow Switch



ST-5

- Brass body
- 8 GPM
- 3600 PSI
- 3 Amp reed switch
- 180°F
- 3/8" inlet/outlet ports



ST-6

Part #	Old No.	Description	List Price
8.712-243.0	410305	ST-5 Vert. Mnt Only (47" wire length)	\$56.80
8.712-245.0	410306	ST-6 Horiz. or Vert. Mnt (47" wire length)	\$61.08
9.803-266.0	109672	Reed Switch (AP) (2 wire)	\$34.93
8.704-122.0	109675	ST-5 Reed Switch	\$45.38
8.704-121.0	109673	ST-6 Reed Switch	\$32.24

Flow Switch



ST-7

- 12 GPM
- 5000 PSI
- Micro switch
- 176°F
- 3/8" inlet/outlet ports

Part #	Description	List Price
8.755-296.0	ST-7 Horiz. or Vert. Mnt (47" wire length)	\$135.27

Phoenix Flow Switch w/ Pilot



- .75-16.0 GPM
- 4000 PSI
- 165°F
- 3 Amp, 250V
- 96" reed cord
- Includes 8mm pilot
- 3/8" F inlet/outlet
- 2.5 lbs
- Mounting hole

Part #	Old No.	Description	List Price
8.712-252.0	410320	Switch with Pilot	\$288.66
8.712-253.0	410322	Reed Switch	\$112.82

7300 PSI Stainless-Steel Flow Switch



- 7300 PSI
- Stainless-steel
- 176°F
- 3/8" inlet/outlet
- 47" wire length
- 1-8 GPM

Part #	Old No.	Description	List Price
8.723-665.0	87236650	ST-505 Flow Switch	\$292.91

Vac Switch – Burner Control

Normally open (NO) switch closes when pump vacuum begins drawing water and opens when vacuum is broken due to pump shutdown or empty water tank.



- 1/4" FPT connect
- Heavy-duty 16 Amp contacts
- 140°F max water temperature

Part #	Old No.	Description	List Price
8.712-391.0	413031	1.5" (HG) Vac Switch	\$29.61
8.712-392.0	413032	2.5" (HG) Vac Switch	\$29.61
8.712-393.0	413034	4.5" (HG) Vac Switch	\$29.61

Pressure Switch



Operation without opening switch case: Blue=Common
CONNECT: Red/Blue=N/C, Blue/Brown=N/O



- 200°F
- Stainless-steel plunger
- 3600 PSI
- 1/4" MPT nipple
- 15 Amp — 115 or 230V AC
- 3-wire — internally wired for either N/O or N/C
- 42" wire length

Part #	Old No.	Description	List Price
8.712-261.0	411060	Pressure Switch (Switches@360 PSI)	\$32.34
8.712-262.0	411060-40	P. Switch 1/4" MPT (Switches@580 PSI)	\$34.92
8.751-272.0		Pressure Switch 3/8"	\$36.33
8.701-311.0	082023	Micro Switch (15 Amp 115/230V AC)	\$18.95

NOTE: 10 AMP 28V DC Micro Switch available. Excellent for use on 12V DC Hot Pressure Washers.

Compact Pressure Switch

3-Amp rating provides the switching power to control fuel solenoids just like the large switches. Body measures 1" x 1-1/4" x 2" (not including wire or connector).



- 3600 PSI max rating
- 580 PSI switch pressure
- 200°F
- 1/4" brass MPT connect stainless-steel plunger
- 3 Amp switch rating – 250V
- 48" – 3-wire cable for use in either NC or NO application:
Blue = Common
Brown = NO
Red = NC

Part #	Old No.	Description	List Price
8.712-260.0	411050	Compact Pressure Switch	\$29.45

Black Pressure Switch



- Brass stem and stainless-steel nipple
- 3600 PSI
- 580 PSI switching pressure
- 45" wire length
- 195°F
- 1/4" male inlet
- 15 Amp
- Weight: 8 oz
- 250V

Part #	Old No.	Description	List Price
9.802-458.0	6-021720	Black Pressure Switch	\$34.75

Red Pressure Switch



- All stainless-steel construction
- 5800 PSI
- 640 PSI switching pressure
- 44" wire length
- 195°F
- 3/8" male inlet
- 15 Amp
- Weight: 10 oz
- 250V

Part #	Old No.	Description	List Price
8.712-267.0	411065	Red Pressure Switch	\$102.54
8.704-572.0	111459	Heavy-duty Micro Switch	\$14.75

Toggle / Push Button Switch



- 7/16" mounting bushing
- 1/2" diameter mounting hole required
- Mounting hardware included

Part #	Old No.	Description	HP*	Connects	List Price
8.712-319.0*	411605	SPST, 20A/110V	1.0	m/spade	\$7.31
8.712-320.0	411607	DPST, 20A/110V		m/spade	\$17.60
8.709-705.0*	337206	DPST, 20A/125V	1.5	screw	\$16.97
8.709-704.0*	337205	DPST, 20A/250V	2.0	screw	\$62.31
8.709-054.0*	285140	SPST, 20A/120V	3/4	m/spade	\$14.49
8.709-065.0*	285189	DPST, 20A/120V	3/4	screw	\$23.75
8.716-078.0		SPST, 20A/120V	1.5		\$6.26
8.709-706.0	337207	Switch Guard			\$1.40
8.716-081.0		Waterproof Switch Protector			\$6.52

Push Button Switches

8.709-053.0	285139	SPST, 5A/120V Push on/ push off		screw	\$28.10
8.709-064.0	285187	SPST, 15A/120V Push and hold on/ release off		screw	\$19.04

*Motor rated

30 AMP Toggle Switch



- 30 Amp 600V – DPST
- With or without box
- Rated for: 2 HP motor @ 115V
3 HP Motor @ 230V

Part #	Old No.	Description	List Price
8.709-696.0	337187	Switch only	\$32.96
8.903-802.0	337188	Switch and Rain Tight Box	\$53.51
8.709-708.0*	337210	Switch w/ NEMA 1 Box	\$95.17

*Not Rain Tight (Baldor Replacement)

High-Limit Switch



8.712-306.0

- Operates as safety device to shut off burner to prevent machine (water) overheating flashing to steam
- Does not turn back on until water has cooled 50°-70°F
- Normally used with other adjustable or fixed range thermostat which regulates water temperature
- 15 Amp @110V/10 Amp @ 220V
- Heavy-duty brass housing (7000 PSI collapse rating)
- UL/CSA-rated, bimetal switch components
- 1/4 male spade lug terminals
- 1/2" MPT external thread connects for attaching conduit or PVC wire connectors

Part #	Old No.	Probe MPT	Temperature	List Price
8.712-301.0	411254	3/8"	120°F	\$42.90
8.712-206.0		3/8"	140°F	\$54.60
8.753-450.0		3/8"	160°F	\$44.82
8.712-304.0	411262	3/8"	170°F	\$29.29
8.712-306.0	411266	3/8"	180°F	\$42.59
8.712-311.0	411276	3/8"	230°F	\$41.97
8.712-179.0		1/2"	180°F	\$43.31
8.712-308.0	411270	1/2"	210°F	\$42.49
8.712-298.0		1/2"	230°F	\$41.19
8.712-316.0	411332	1/2"	330°F	\$42.02
8.705-351.0	141538	1/2"	PVC Coupler	\$1.14

High-Limit Switch w/ Wire Lead



- Operates as safety device to shut off burner to prevent machine (water) overheating flashing to steam
- Does not turn back on until water has cooled 50°-70°F
- Normally used with other adjustable or fixed range thermostat which regulates water temperature
- 15 Amp @110V/10 Amp @ 220V
- Heavy-duty brass housing (7000 PSI collapse rating)
- UL/CSA-rated, bimetal switch components
- 1/4" male spade lug terminals
- 1/2" MPT external thread connects for attaching conduit or PVC wire connectors

Part #	Probe MPT	Wire Lead	Temperature	List Price
8.712-185.0	1/2"	42"	225°F	\$40.94
8.712-205.0	1/2"	42"	330°F	\$43.42

EATON Cutler-Hammer DP Contactors

Cutler-Hammer



- Cutler-Hammer quality
- Type C25 definite purpose contactors feature a compact, efficient design with low-VA coil
- Din rail mounting

Part #	Coil Voltage	FL Amps	Motor Hp @ 115V 1ph	Motor Hp @ 230V 1ph	Motor Hp @ 230V 3ph	Motor Hp @ 460V 3ph	Motor Hp @ 575V 3ph	List Price
8.724-267.0	24V	15	.75	2	3	5	5	\$40.21
8.724-264.0	115V	15	.75	2	3	5	5	\$39.81
8.724-265.0	230V	15	.75	2	3	5	5	\$38.30
8.724-266.0	460V	15	.75	2	3	5	5	\$33.95
8.724-269.0	24V	25	2	3	7.5	10	10	\$43.42
8.724-268.0	115V	25	2	3	7.5	10	10	\$43.47
8.724-270.0	230V	25	2	3	7.5	10	10	\$47.04
8.724-271.0	460V	25	2	3	7.5	10	10	\$48.70
8.724-275.0	24V	30	2	5	10	15	15	\$54.70
8.724-272.0	115V	30	2	5	10	15	15	\$54.74
8.724-273.0	230V	30	2	5	10	15	15	\$53.41
8.724-274.0	380V	30	2	5	10	15	15	\$51.80
8.724-280.0	24V	40	3	7.5	10	20	20	\$60.29
8.724-276.0	115V	40	3	7.5	10	20	20	\$57.11
8.724-277.0	230V	40	3	7.5	10	20	20	\$57.39
8.724-279.0	380V	40	3	7.5	10	20	20	\$48.23
8.724-278.0	460V	40	3	7.5	10	20	20	\$57.70
8.724-283.0	24V	50	3	10	15	30	30	\$67.83
8.724-281.0	115V	50	3	10	15	30	30	\$67.83
8.724-282.0	230V	50	3	10	15	30	30	\$69.19
8.724-286.0	24V	60	5	10	20	40	40	\$161.46
8.724-284.0	115V	60	5	10	20	40	40	\$155.25
8.724-285.0	230V	60	5	10	20	40	40	\$160.43
8.735-015.0	115V	65	5	15	25	50	60	\$314.64

XT Overloads for DP Contactors Cutler-Hammer



- Cutler-Hammer quality
- Direct heated bimetal elements
- Adjustable trip current
- Manual/automatic reset

Part #	Amp Range	List Price
8.724-297.0	0.4 - 0.6	\$55.84
8.724-298.0	0.6 - 1.0	\$55.32
8.724-299.0	1.0 - 1.6	\$47.87
8.724-300.0	1.6 - 2.4	\$61.07
8.724-301.0	2.4 - 4.0	\$61.07
8.724-302.0	4.0 - 6.0	\$68.93
8.724-303.0	6.0 - 10.0	\$60.13
8.724-312.0	10.0 - 16.0	\$58.86
8.724-304.0	16.0 - 24.0	\$58.71
8.724-305.0	24.0 - 32.0	\$60.82
8.724-306.0	24.0 - 40.0	\$104.03
8.724-307.0	40.0 - 57.0	\$107.12

Push Button and Contact Blocks Cutler-Hammer

Cutler-Hammer



9.802-534.0

- Cutler-Hammer quality
- Heavy-duty
- Water tight / oil tight



9.803-974.0



9.803-973.0



8.716-718.0

Part #	Old No.	Model No.	Description	List Price
9.803-666.0	6-2004	CH C320KGS3	Contact Block, N/O, N/C	\$56.51
9.802-534.0	6-2000	CH E22B1	Contact Block, N/C	\$13.87
9.802-535.0	6-2001	CH E22B2	Contact Block, N/O	\$13.87
9.803-974.0	6-2021	CH E22PB3	Switch, Green Push Button	\$11.59
9.803-973.0	6-2022	CH E22EB2	Switch, Red Push Button	\$14.02
8.716-718.0	6-2023	CH E22VB51	Switch, 2-position Lever	\$24.84

Relays



9.802-468.0



8.716-230.0



9.802-467.0



9.802-470.0



8.716-264.0



Part #	Old No.	Description	List Price
9.802-468.0	6-03621	120V, RH2B-UI-AC120 for Pressure Washers	\$21.94
8.716-209.0	6-03521	240V, RH2B-UI-AC240	\$29.60
9.802-467.0	6-03541	Base, SH2B-05 for IDEC	\$19.36
8.716-230.0	6-0367	24V, IDEC CLP	\$23.70
8.716-264.0	6-0381	Power Deltrol, 120V for SJ-5	\$29.46
8.716-257.0	6-0374	Relay, Power Omron G4B112T1FDCUSR PAC120 for Delta/Alpha	\$60.60
9.802-470.0	6-03671	P&B/VF4-41F11, 12V DC, 40 Amp for 12V DC Units 13 HP and Below	\$22.87
9.802-471.0	6-036711	Relay, P&B, 24V/40 A for 12V DC Units over 13 HP	\$16.46

Step-Down Transformers



8.716-899.0



9.802-553.0



8.716-904.0

- Industrial duty
- High-quality Cutler-Hammer
- Drops primary voltage to selected secondary voltage

Part #	Old No.	Primary Voltage	Secondary Voltage	Size	List Price
8.716-593.0	6-05234	600V	120-240V	1.0KvA	\$699.66
8.716-899.0	6-6031	380/400/415	110/220V	.750KvA	\$300.15
9.802-553.0	6-60121	120/240V	24V	.050KvA	\$77.68
8.716-904.0	6-6035	120/240V	24V	.100KvA	\$110.21
8.716-883.0	6-60161	208/230/460V	24/115V	.050KvA	\$77.37
9.804-556.0	6-60141	208/277V	120V	.050KvA	\$72.55
8.716-882.0	6-60151	208/277V	120V	.075KvA	\$104.54
9.803-971.0	6-6025	380V	24V	.050KvA	\$70.28
8.716-875.0	6-60051	240/480V	120/240V	.200KvA	\$140.08
9.802-550.0	6-60021	240/480V	120/240V	.500KvA	\$242.19
9.802-552.0	6-60111	240/480V	120V	.075KvA	\$92.70
9.802-551.0	6-60101	240/480V	120V	.050KvA	\$74.16
9.803-668.0	6-60131	550V/575/600V	115V	.050KvA	\$74.21

Junction Boxes



9.802-474.0



8.716-269.0



8.716-271.0



9.802-475.0



9.802-476.0



9.802-477.0



8.716-280.0, 8.716-281.0, 8.716-272.0



8.716-320.0



8.716-321.0



8.716-322.0



8.716-326.0

Part #	Old No.	Description	List Price
9.802-474.0	6-0390	VNG Remote, Plastic	\$188.37
8.716-269.0	6-03901	12" x 12" x 4", Metal VNG Remote Box	\$82.28
8.716-271.0	6-03904	Fiberglass, NEMA4 for PE Units	\$126.27
8.716-272.0	6-03906	12" x 10" x 5.25" for Solid Sep	\$235.98
9.802-475.0	6-03907	8" x 8" x 4", Plastic Alpha, for SEA 3-1100	\$74.47
9.802-476.0	6-03909	10" x 8" x 6", Box, Plastic with Lid for SEA	\$183.20
9.802-477.0	6-03910	Box, Plastic without Lid E9801	\$16.77
9.802-478.0	6-03911	Lid, Plastic for 9.802-477.0	\$8.90
8.716-280.0	6-03912	18" x 16" x 9.25", Plastic for CLP, WB	\$436.77
8.716-281.0	6-03913	14" x 16" x 6.75", Plastic for HBG, AMC	\$409.86
8.716-320.0	6-0409	Cover, Duplex Receptacle for Alpha	\$6.37
8.716-321.0	6-0410	2" x 4", 3-hole, 1/2" WB, for CLP	\$8.90
8.716-322.0	6-04101	2" x 4", Extension for 8.716-321.0, 8.716-323.0, 8.716-324.0	\$13.14
8.716-323.0	6-04102	2" x 4", 5-hole, 1/2" for CLP	\$15.37
8.716-324.0	6-04103	2" x 4", 4-hole, 1/2" for CLP	\$9.94
8.716-326.0	6-04104	4" x 4", 3-hole, SK Series for Alpha/ PK	\$24.84
8.716-327.0	6-041041	4" x 4", 5-hole, 1/2" for WB	\$42.23
8.716-329.0	6-041043	4" x 4" SK, Cover Plate, for WB for 6-00041	\$6.93
9.802-483.0	6-0411	2" x 4", Cover Plate, for 8.716-321.0	\$2.28
9.802-484.0	6-04110	2" x 4", Junction 3-hole, 3/4"	\$10.66
8.716-339.0	6-041100	2" x 4", 3-hole, 1" for ENG	\$30.17

Enclosure Box for Magnetic Motor Starter Sets



- NEMA 65 non-metallic enclosure dimensions: 4-1/3" W, 4" D x 6" H
- 8 (1/2"-3/4") wiring knockouts on box
- Holes pre-drilled for mounting contactor and overloads with mounting screws included

Part #	Old No.	Description	List Price
8.902-525.0	260268X	Box, Toggle and Hardware	\$82.33

Manual Motor Starter w/ Sealed Box



- 25 Amp with adjustable overload
- Adjustment range 20-25 Amps
- Sealed box 3-1/4" W x 3-1/2" D x 6-1/2" H
- 110-500V IEC-rated
- Two-cord grips fit 1/2" threaded knockouts
- Protective cover over buttons
- Single and 3-phase wiring instructions

Part #	Old No.	Description	List Price
8.709-709.0	337212	Motor Starter	\$140.76

RainTite Switch Box



- UL 728A
- 2-3/4" x 5-1/2" x 2" box
- Three 1/2" tapped holes
- Box includes two plugs, ground screw and mounting lugs
- Cover includes gasket

Part #	Old No.	Description	List Price
8.709-702.0	337203	RainTite Switch Box	\$9.00
8.709-703.0	337204	Switch Box Cover	\$3.47

Timer



- Preset and adjustable available
- Heavy-duty

Part #	Old No.	Description	List Price
9.802-472.0	6-036880	Solid State, 120V, 5-60 Min for Auto Start	\$107.12

Fuses

- Full range of fuses
- Protect your equipment



Part #	Old No.	Code	Max Voltage	Amps	List Price
9.802-463.0	6-022970	FNM1/2	250V	0.5	\$3.93
9.802-464.0	6-0229810	FNM8/10	250V	0.8	\$3.76
8.716-173.0	6-0229710	FNM1	250V	1.0	\$3.98
9.803-977.0	6-02320	FNM2-1/2	250V	2.5	\$3.88
8.716-187.0	6-023080	FNM3	250V	3.0	\$3.98
9.803-664.0	6-023090	FNM5	250V	5.0	\$3.97
8.716-194.0	6-02321	FNM7	250V	7.0	\$4.22
9.802-460.0	6-022910	FNM8	250V	8.0	\$3.81
8.716-165.0	6-022920	FNM10	250V	10.0	\$3.98



8.716-191.0	6-02311	FNQ3/10	500V	0.3	\$15.99
8.716-192.0	6-02312	FNQ6/10	500V	0.6	\$10.09
9.802-465.0	6-02306	FNQ-R-3	600V	3.0	\$7.21



8.716-169.0	6-02296	KTK-R1/4	600V	0.25	\$7.71
9.802-462.0	6-02295	KTK-R1/2	480V	0.5	\$6.68
9.933-007.0	6-02294	KTK-R1	240V	1.0	\$6.73
8.716-177.0	6-022982	KTK-R1-1/2	600V	1.5	\$6.62
9.803-663.0	6-02299	KTK-R2	120V	2.0	\$7.30
8.716-179.0	6-022990	KTK-R2-1/2	600V	2.5	\$6.88
8.716-180.0	6-022992	KTK-R4	600V	4.0	\$7.36
9.804-050.0	6-02307	KTK-R5	600V	5.0	\$7.45
8.716-183.0	6-02304	KTK-R30	600V	30.0	\$20.91



8.716-170.0	6-02297	MDL1/2	120V	0.5	\$4.31
8.716-175.0	6-022981	MDL3/4	250V	0.75	\$2.48
8.716-172.0	6-022971	MDL1	250V	1.0	\$2.54
8.716-174.0	6-02298	MDL2-1/2	24V	2.5	\$2.79
8.716-186.0	6-02308	MDL3	250V	3.0	\$2.43
8.716-188.0	6-02309	MDL5	250V	5.0	\$2.69
8.716-161.0	6-02291	MDL7-1/2	250V	7.5	\$4.04
8.716-163.0	6-022911	MDL8	250V	8.0	\$2.43

Circuit Breakers



- Provides protection against excessive Amp draw

Part #	Old No.	Description	List Price
9.802-485.0	6-041250	25 Amp (All 12V Systems)	\$9.40

60 AMP On/Off Cam Switch and Box

Cam action fast "make-break" to reduce arcing.



- 60 Amp disconnect rating
- Four 1/2" knock-outs
- Versatile mounting
- Motor ratings:
7.5 HP @ 240vt 1Ø
5.0 HP @ 240vt 3Ø
30 HP @ 480vt 3Ø

Part #	Old No.	Description	List Price
8.712-217.0	410206	60 Amp Switch w/ Large Box 4-1/2" w x 7" H x 3-3/4" D	\$181.13
8.712-211.0	410190	60 Amp Switch only, No Knob	\$121.10
8.712-212.0	410192	Box only 3-7/8" x 4-7/8" x 2-3/4" for 410190 switch using 10 gage/smaller wire	\$57.24
8.700-489.0	076521	Knob	\$9.73

NOTE: Switch does not have thermal overload protection.

Machine Control Cam Switches – 3-Position



- Heavy-duty rotary cam switches
- Legend plate reads off/pump/burner
- Quick make/break action reduces arcing
- Wiring boot included (except 410242-3)
- Legend plate 2-1/2" square
- 4-screw mounting

Part #	Old No.	Model	AMP Rating	Voltage	Phase	List Price
8.712-219.0*	410210	S220-1686	20	110V	1Ø	\$57.39
8.712-224.0*	410221	S220-1687	20	220V	1Ø	\$68.03
8.712-225.0*	410223	S220-1688	20	220V	3Ø	\$89.84
8.712-227.0*	410231	S225-1686	30	110V	1Ø	\$85.23
8.712-228.0*	410232	S225-1687	30	220V	1Ø	\$90.33
8.712-229.0*	410233	S225-1688	30	220V	3Ø	\$154.22
8.712-234.0	410242	S432-4095	40	240V	1Ø	\$219.42
8.712-235.0	410243	S432-1402	40	480V	3Ø	\$238.05

Single-Hole Mounting – requires 1 22mm (7/8" Dia) hole

8.712-218.0	410208	220-1789	20	110V	1Ø	\$70.95
Replacement Knob – fits those part numbers above marked with an asterisk ()						
8.700-258.0	075052	Replacement Knob				\$15.27

"Big Boot" Cam Switch – 3-Position

Large rectangular boot for easier wiring.



- Mounting configuration and electrical ratings same as "S" switches

Part #	Old No.	Model	AMP Rating	Voltage	Phase	List Price
8.712-238.0	410260	T225-1686	30	110V	1Ø	\$93.20
8.712-241.0	410265	T225-1688	30	240V	3Ø	\$159.39
Single-Hole Mounting – requires one 22mm (7/8" Dia) hole						
8.712-223.0	410219	220-1843	20	220V	1Ø	\$80.42

Universal "Elektra"

UL/CSA-rated machine control cam switches.



8.712-236.0



8.712-237.0



8.712-240.0

- Position – "off" – "pump burner"
- Quick make/break action — reduces arcing
- 2- or 4-screw mount (2-1/2" square legend plate)
- (Matches: Salzer/Kraus – Naimer/Bremas & Klockner – Moeller mounts)
- "Boot" has plenty of wiring room
- Screw-to-screw/terminal-to-terminal replacement for salzer "S" and "J" type switches above
- "Tite boot" excellent dust and moisture seal
- Contacts UL/CSA-rated:
25 Amp vs 20 Amp,
35 Amp vs 30 Amp,
50 Amp vs 40 Amp

Part #	Old No.	AMP Rating	Wiring Poles	Phase	Voltage	HP Rating	List Price
8.712-236.0	410251	25	1	1	120	1.5	\$132.48
8.712-237.0	410253	25	2	1	120/240	1.5/2.0	\$138.32
8.712-240.0	410263	35	2	1	120/240	2/3	\$160.65
8.712-242.0	410267	50	2	1	120/240	3/7.5	\$213.21

NOTE: None of the Elektra switches are for use on 3-phase motors without adding fuses or thermal overload.



"Elektra" On/Off Switch with box
UL/CSA-rated 25 and 35 Amp. Compact 3-1/4" square x 3-3/4" deep enclosure "versatile mount".

Part #	Old No.	AMP Rating	Wiring Poles	Phase	Voltage	HP Rating	List Price
8.712-214.0	410203	25A	2	1	120/240	1.5/2	\$158.36
8.712-216.0	410205	35	2	1	120/240	2/3	\$212.18

NOTE: None of the Elektra switches are for use on 3-phase motors without adding fuses or thermal overload.

On/Off Cam Switch



- Legend plate: on/off
- Tear-drop-shaped knob
- Face plate 2-1/2" square
- Motor ratings:
410202 – 1-1/2 HP/ 110V
410204 – 6 HP/ 240V

Part #	Old No.	Description	List Price
8.712-213.0	410202	20 Amp/ 110V	\$79.07
8.712-215.0	410204	28 Amp/ 240V	\$90.92

Rocker Switches

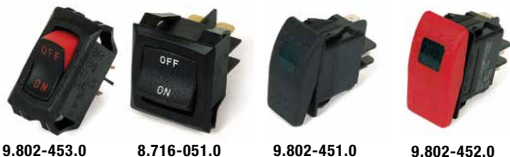

- On/off switch
- Lighted available
- 125V/250V

Part #	Old No.	Description	AMP	Voltage	List Price
9.802-453.0	6-020251	Curvette, V. Carling	16/10	125/250	\$3.24
8.716-051.0	6-020252	Curvette, 2-pos	20/15	125/250	\$10.45
8.716-052.0	6-020253	Curvette, 3-pos	16/10	125/250	\$3.26
9.802-451.0	6-020240	Carling, Green Lght, 2-pos	15/10	125/250	\$16.11
9.802-452.0	6-020241	Carling, Red Lght, 3-pos	15/10	125/250	\$24.68
8.716-037.0		Rocker	15/10	125/250	\$31.52

Indicator Lights



- Easily mounts to control panel
- Available in 12V, 24V, and 125V
- Great for remote applications

Part #	Old No.	Voltage	Color	List Price
8.716-095.0	6-02053	125V	Red	\$9.21
9.802-455.0	6-020530	125V	Green	\$8.91
8.716-408.0	6-050413	125V	Amber	\$8.14
9.803-651.0	6-0399	24V	Red	\$9.78
9.803-652.0	6-03990	24V	Green	\$8.75
8.716-097.0	6-02059	12V	Red	\$12.68
9.802-456.0	6-020590	12V	Green	\$8.52

Digital Monitor

Provides accurate testing and monitoring of electrical outlets and systems.



- Constantly monitors voltage and frequency indicated potential improper polarity and ground wiring
- Accurate testing and monitoring of all AC power sources
- RMS voltage and frequency meter
- Multi-tone fault alarm
- Hands-free auto reset
- Advanced microelectronics
- One-button operation

Part #	Description	List Price
8.749-947.0	Digital Monitor	\$153.18

Winco AC Generator

2400 Watt, 120 VT, 3600 RPM, 17 Amps.



- Industrial-duty – three carbon brushes
- The standard in the pressure washing industry: Winco 2FS2MP-1
- Starts and runs 1/2 HP motor
- 5/8" diameter shaft rotates either direction
- Extra slip ring for smoother power curve during motor starting
- Dual-sealed permanent bearings
- 15" L x 6.5" W x 6.75" H
- 59 lbs weight
- Conforms to UL1004-1, UL1004-4, and CSA 22.2 No. 100-04

Part #	Old No.	Description	List Price
8.716-610.0	337440	Winco AC Generator	\$1,086.65

- Genuine Winco parts
- Save downtime — we stock below items and more!

Part #	Old No.	Description	No. Req'd	List Price
Winco Repair Parts				
8.700-603.0	078451	Bearings	2	\$21.99
8.716-615.0	078452	Brushes	3	\$18.22
8.700-607.0	078455	Rectifier	1	\$92.63
8.700-609.0	078457	Receptacle	2	\$14.28
8.700-611.0	078459	Fan	1	\$12.63

Voltmaster Generator

2500 Watt/120V/21.6 Amp @ 3,600 RPM.



- Industrial-type watertight enclosure (11-5/8" x 7-1/2" diameter)
- Brushless design
- All copper windings — high-surge capacity
- Circuit breaker protection (standard)
- Shaft rotates either direction
- 7/8" shaft, two sealed (ball) bearings
- 36.5 lbs weight

Part #	Old No.	Description	List Price
8.709-810.0	337441	2500 Watt Generator	\$829.15

Adjustable Thermostat

With panel-mount controls.



- 4000 PSI
- 302°F
- 3-1/2" immersion bulb w/ 60" capillary tube
- Accuracy ± 2.5%
- Temperature change response within ± 6°F
- 16 Amp – 250V
- Large, easy-read dial
- Seal, nut and 1/2" transition coupling included

Part #	Old No.	Description	List Price
8.712-494.0	430050	0-194°F Thermostat	\$62.57
8.712-497.0	430058	0-248°F Thermostat	\$59.12
8.904-557.0	430060	0-302°F Thermostat	\$59.69
8.750-096.0		Knob 150°C/302°F	\$1.55

Adjustable Flow-Thru Thermostat



8.914-555.0



8.700-501.0

- Stainless-steel case
- Silver contacts
- Ceramic insulation
- Stop collar
- Tension adjusting screw
- 3000 PSI
- 10 Amps – 110V
- 5 Amps – 220V
- Adjustable 85°-195°
- 1/2" inlet, 3/8" outlet
- Fenwall inside

Part #	Old No.	Description	List Price
8.904-555.0	430027	Thermostat	\$183.20
8.700-501.0	076731	Switch Only	\$102.36

Brass In-line Thermostat

In-line controls for pressure washers and steamers.



- Positive bimetal temperature control
- 1/2" inlet/outlet FPT ports
- 3000 PSI max working pressure
- Universal 1/4" spade terminal connection

Part #	Old No.	Description	List Price
8.712-492.0	430025	60-230°F	\$104.54
8.712-493.0	430035	60-340°F	\$126.27

Cord Caps/Plugs



- Industrial-quality
- Dead front cord caps — nylon body straight plugs and "auto-clamp" for cord
- 337013 angle plug has vinyl body and both 30A and 50A neutral leg

Part #	Old No.	Description	List Price
8.709-653.0	337000	15A/120V, Black Nylon	\$10.30
8.709-655.0	337004	20A/120V, Black Nylon	\$14.80
8.709-656.0	337006	20A/250V, Black Nylon	\$15.84
8.709-659.0	337013	30A-50A/250V, Black Vinyl	\$34.72

Vinyl Electrical Tape



- Premium grade – 7 mil
- UL-approved

Part #	Old No.	Description	List Price
8.704-706.0	118910	Roll 3/4" x 60'	\$2.69

Romex Connectors (Metal)



Part #	Old No.	Description	List Price
8.709-663.0	337020	1/2" Strt. Connector	\$0.82
8.709-664.0	337021	3/4" Strt. Connector	\$1.86
8.709-660.0	337017	1/2" Lock Nut Only	\$0.52
8.709-661.0	337018	3/4" Lock Nut Only	\$0.27

Liquid-Tight Strain Relief Connector for Cable, Wire and Tubing

Keep water-tight NEMA-4 and 4x enclosures water-tight with these unique fittings.



DOME NUT WITH INSIDE TAPER. As the dome nut is tightened, the seal ring grips, holding the cable wire or tubing positively in place.

LEAD-SCREW THREAD. The dome nut can be firmly tightened due to the high strength lead-screw thread.

Part #	Type	Thread	Cord Size	Cord OD	Length	List Price
8.709-687.0	Dome	1/2" NPT	14/3-12/3	.230"-.470"	1.8"	\$4.09
8.709-688.0	Dome	3/4" NPT	14/3-12/3	.350"-.630"	2.0"	\$9.06
8.709-689.0	Dome	3/4" NPT	12/3-10/4	.510"-.710"	2.0"	\$10.14

PLASTIC JAM NUTS

Part #	Thread	List Price
9.802-525.0	1/2" NPT	\$0.90
9.802-526.0	3/4" NPT	\$1.29



CLAMPING SPLINES. Various sizes and odd-shaped cables, wires and tubing can be accommodated due to overlapping diagonally split clamping splines.

Part #	Type	Thread	Cord Size	Cord OD	Length	List Price
8.709-690.0	Flex	1/2" NPT	14/3-12/3	.230"-.470"	4.3"	\$6.57
8.709-692.0	Flex	3/4" NPT	12/3-10/4	.51"-.71"	5.2"	\$14.80

CONDUIT

Part #	Description	List Price
9.802-448.0	Watertight Flex 1/2" x 100' Box	\$2.16

Wire Loom – For Wiring Harnesses



- Protects wires from abrasion and crushing
- Controls bundles of wires and allows for multiple exits at wiring points
- "Factory-perfect" look for all machines

Part #	Old No.	Description	List Price
8.709-679.0	337120	1/4" ID 100' Roll	\$42.49
8.709-680.0	337121	3/8" ID 100' Roll	\$50.15
8.709-681.0	337122	1/2" ID 100' Roll	\$55.32
8.709-682.0	337123	5/8" ID 100' Roll	\$55.01

GFCI Module 20 Amp – 120V or 240V

Not recommended for field service.



- Using 120V or 240V shop attachable module; attach your power cord length as required
- Use with 16-12 gauge SJ, SJO or SJT 3-wire cords
- 20 Amp rating at 120V or 240V 60 Hz

Part #	Old No.	Description	List Price
8.709-858.0	337642	GFCI Module 1PH	\$129.38
8.709-859.0	337643	GFCI Module 3PH (not pictured)	\$128.34

Ground Fault Circuit Interrupters (GFCI)

GFCIs protect people and equipment by interrupting potentially lethal ground circuits exceeding 6mA. The dangers of electrical shocks have been long known — GFCIs are the only real way to be safe. Most city and county codes now require GFCI protection on power cleaning equipment.



- UL-listed
- Three wire circuits
- Transient voltage protection
- 4-6mA ground fault protection
- Grounded neutral protection
- Mechanical trip indicator
- Compact size
- Rugged construction
- Radio frequency interference suppression

Part #	Old No.	Volt	Amp	Length	Plug Included	List Price
8.709-850.0	337626	120V	15A	12'	Yes	\$73.43
9.802-432.0		120V	15A	36'	Yes	\$100.71
8.709-842.0	337607	120V	20A	12'	No	\$97.39
8.903-807.0	337608	120V	20A	12'	Yes	\$104.54
8.709-843.0	337609	120V	20A	35'	Yes	\$152.15
9.802-431.0		120V	20A	36'	Yes	\$115.36
9.802-433.0	6-010631	240V	20A	36'	Yes	\$225.57
9.802-434.0		240V	40A	36'	Yes	\$1,080.47
8.709-860.0	337645	240V	30A	6'	No	\$247.37
8.709-853.0	337632	240V	30A	6'	Yes	\$292.91
8.709-861.0	337647	240V	30A	12'	No	\$283.59
8.709-854.0	337634	240V	30A	12'	Yes	\$308.43
8.709-862.0	337649	240V	30A	35'	No	\$288.77
8.709-855.0	337635	240V	30A	35'	Yes	\$332.24
9.802-430.0		240V	30A	36'	Yes	\$248.23

GFCI Plug without Cord

8.709-847.0	337615	120V	15A	N/A	Yes	\$65.93
8.709-846.0	337614	120V	20A	N/A	Yes	\$79.10

NOTE: User-attached plug also includes the sealant necessary to attach the power cord per UL specification.

Molded Plastic Float Tanks



- Molded polypropylene
- 7-liter size: 13" x 5" x 6"
- 1-gallon size: 10" x 5" x 8"
- No holes for max flexibility
- 1-gallon tank has tight-fitting lid, included
- 7-liter tank lid is snap-on and sold separately

Part #	Old No.	Description	List Price
8.710-026.0	343002	7-Liter Tank Only	\$20.34
8.710-027.0	343003	7-Liter Tank Lid	\$8.95
8.710-028.0	343004P	1-Gallon Tank w/ Lid	\$21.22

Stainless-Steel Float Tank



- Fully welded and water tight
- 2.8-gallon capacity
- 12" x 9" x 6"
- 16 gauge #303 stainless-steel
- 1/2" full coupling (stainless-steel) inlet/outlet
- Convenient mounting tabs

Part #	Old No.	Description	List Price
8.710-029.0	343006	Stainless-Steel Float Tank	\$251.51
8.710-034.0	343016	Stainless-Steel Lid	\$50.97

9-Gallon Diesel Fuel Tank



- Strap or bolt mount (4/5/16" inserts in bottom)
- Metal inset 3/8" inlet/return lines
- Black – crosslinked PE
- Vented fuel cap
- Filler neck doesn't extend beyond tank wall
- Compact size: 19-3/4" L x 12" W x 10-1/2" H

Part #	Old No.	Description	List Price
8.710-142.0	344735	9-Gallon Fuel Tank – Plastic	\$211.15

NOTE: Includes fuel cap.

Fuel Tanks



8.751-293.0



8.751-294.0

- EPA/CARB-compliant
- Seamless one-piece construction of marine grade, UV-protected polyethylene
- Built-in reserve (when gauge reads "empty", tilt to access additional fuel)
- Two-stage click when closed fuel cap
- 90° fuel withdrawal fitting
- Easy-to-read sight gauge
- Four shapes and capacities from which to choose

Part #	Gallons	Length	Width	Height	List Price
8.751-294.0	6	21.18"	13.5"	10"	\$108.68
8.751-296.0	12	20.375"	13.75"	14.75"	\$217.35
8.751-293.0	12	24.25"	18"	11"	\$219.42

Fuel Caps



- For gas or diesel fuel tanks
- Fits standard 2-1/4" fuel necks

Part #	Old No.	Description	List Price
8.710-137.0	344725	Fuel Cap	\$21.22
8.701-700.0	091520	Fuel Cap with Gauge 10"	\$50.77

Battery Boxes with Cover, Marine Style

Protect batteries on pressure washers, boats or other industrial equipment.



- Attractive molded polypropylene
- Complete with hold-down cleats and strap for cover

Small:
8-1/2" L x 6" W x 8-1/2" H

Large:
11-1/4" L x 7-3/4" W x 10-3/4" H

Part #	Old No.	Description	List Price
9.802-090.0	306625	Small Box	\$22.56
9.802-075.0	306627	Large Box	\$20.14

Flat-Free Tires

Flat-Free Tires provide the bounce and load handling characteristics similar to an air filled tire - with the benefit of never going flat. Flat-Free tires are lightweight, non-marking, and come mounted on a heavy-duty steel rim with shielded ball bearings. Not for highway use.



- Heavy-duty Steel Rim
- Non-Marking
- 4" Steel Rim: Max load 300 lbs
- 12" Steel Rim: Max load 375 lbs

Part #	Description	List Price
8.711-898.0	Wheel & Tire Assembly, 4" Steel Rim	\$38.00
8.754-435.0	Wheel & PU Tire Assembly, 12" Steel Rim	\$40.00

Complete Wheels



8.711-901.0

9.802-270.0

- High-quality pneumatic, and semi pneumatic
- Fits 5/8" shaft



9.802-271.0

8.712-762.0

Part #	Old No.	Description	List Price
8.711-901.0	4-0304	10" Mag	\$49.21
9.802-270.0	4-0303	10" Steel Rim w/ Tube	\$16.77
9.802-271.0	4-0307	13" Steel Rim	\$24.42
8.712-762.0	480115	10" White steel rim, 3/4" Hub Tubeless	\$36.54
8.711-905.0	4-03071	6" Steel Rim Foam Filled	\$73.38
8.711-921.0		6" Tube Only	\$13.71
8.712-767.0		10" Tube Only	\$14.85
9.802-274.0		10" x 2-3/4" Hard Rubber Wheel	\$20.96
8.711-908.0		3" Gray Caster Wheel	\$46.78



Interchangeable Bearings

Part #	Old No.	Description	List Price
8.700-484.0	076504	5/8" Bore Bearing	\$3.70
8.700-486.0	076505	3/4" Bore Bearing	\$3.70
8.700-485.0	076504P	5/8" Nylon Bearing	\$2.43

Hub Caps and Collars

Part #	Old No.	Description	List Price
8.700-183.0	071625	3/4" Hub cap	\$2.79
8.700-184.0	071627	5/8" Hub cap	\$2.12
9.802-782.0		5/8" Bore Shaft Collar	\$1.35

Miscellaneous Parts

Part #	Description	List Price
8.719-064.0	Chassis Knob 5/16" Thread, Black	\$4.86
9.802-066.0	Soft Rubber Foot Pad	\$2.95
8.932-992.0	Vibration Isolator 3/8"	\$10.71

Legacy Undercarriage Cleaner



Legacy is proud to offer the Undercarriage Cleaner, an ideal way to clean under vehicles and heavy equipment.

- No more crawling under a vehicle
- Simply connect to your hot or cold water pressure washer
- Easy to handle and maneuver
- Removes road grime, fuel and oil contaminants
- Removes snow sludge and ice
- Provides a clean working environment for technicians
- Stainless-steel rotating assembly built to withstand pressures up to 4000 PSI and 250°F
- 5.5" required clearance
- Four nozzles:
(2) 0° #2.0, (2) 25° #2.0



Part #	Description	List Price
8.749-303.0	Undercarriage Cleaner	\$1,152.57

Surface Cleaner Nozzle Recommendation

Determine the correct nozzle size for the pressure washer being used with the surface cleaner. Never use a smaller size nozzle as this will prematurely wear out the unloader valve on the pressure washer. The Legacy Undercarriage Cleaner and A+ Surface Cleaners come supplied with nozzles, for other surface cleaners, nozzles must be purchased separately. Threaded nozzles are listed on pages 45-46 of the catalog, to determine your pressure washer nozzle size refer to chart on page 43. Contact your RSM on other sizes or surface cleaner spray bars that use 4 nozzles or other sizes.

Pressure Washer Nozzle Size		15° x 1/4" MPT	25° x 1/4" MPT
# 3.5 and # 4.0	2 each	#2.0	#2.0
#4.5 and # 5.0	2 each	#2.5	#2.5
# 5.5 and # 6.0	2 each	#3.0	#3.0
# 6.5 and # 7.0	2 each	#3.5	#3.5
# 7.5 and # 8.0	2 each	#4.0	#4.0

A+ Surface Cleaner



Fast, even cleaning for large flat surfaces. Quickly cleans concrete & asphalt, and removes grime and deposits from tennis courts, ramps, and decks. Also great for factory floors, semi-trailer floors & drive-throughs. Cleans better and faster than spray wand alone, with no striping. Use with hot or cold water. Handles water up to 212° F to disinfect bathrooms and kitchens. Safety lock prevents accidental spraying.



- Two spinning nozzles 'floats' cleaner above the ground
- Circular design allows a zero wall clearance
- Stainless steel housing and handle
- Comfort Grip trigger handle
- 3/8" male quick connector plugs into your pressure washer's hose
- Reduces overspray on walls, landscaping, and operator
- Comes with two #2.0 nozzles (for machines up to #4.0 nozzles), 25° nozzles rated up to 8 GPM & 4000 PSI
- Requires at least 3 GPM & 2000 PSI

Part #	Description	List Price
8.753-572.0	A+SC21 Rotary Surface Cleaner, 21"	\$804.32
8.753-573.0	A+SC24 Rotary Surface Cleaner, 24"	\$900.34

Whisper Wash Flat Surface Cleaners

- Saves labor, fuel and water
- Eliminates overspray and zebra striping
- Use with conventional pressure washers
- Use with cold or hot water
- Balanced spray bar
- Quick connection
- 2,000-4,000 PSI
- 2500 RPM

Applications:

- Service stations
- Pool and patio decks
- Warehouse floors
- Loading docks
- Parking lots
- Public facilities
- Restaurants
- Gondolas
- Stadiums
- Marina docks
- Driveways
- Sidewalks
- School yards
- And lots more!!

The "Maxima 36"

- Portable breakaway handle
- 212°F
- 4-10 GPM
- 2500 RPM
- Dimensions:
Cover: 36"
Handle: 77"
- Weight 37 lbs



Part #	Original No.	Description	List Price
8.710-089.0	343636	Maxima 36	\$2,352.52

Whisper Wash Flat Surface Cleaners - continued

Ground Force

- Flip and fold handle
- Choice of two or four nozzles
- Rebuildable swivel
- 212°F
- 4-10 GPM
- Dimensions: 24" x 60" x 9"
- Weight: 29 lbs



Part #	Original No.	Description	List Price
8.710-076.0	343608	Ground Force	\$1,902.33

The "Big Guy"

- Powder-coated aluminum housing
- Oversized, self-lubricating twin thrust bearings
- Choice of two or four nozzles
- 10" pneumatic tires, 4" caster
- Crafted with durable stainless-steel and aircraft aluminum
- 212°F
- 4-10 GPM
- Dimensions: 28" x 44" x 12"
- Weight: 48 lbs



Part #	Original No.	Description	List Price
8.710-074.0	343606	Whisper Wash Big Guy Two Nozzles	\$1,835.13
8.710-075.0	343607	Whisper Wash Big Guy Four Nozzles	\$1,974.78
8.750-604.0	092110	Swivel, Complete Big Guy and Classic	\$585.04
8.701-879.0	092105	Repair Kit, Seal, Big Guy and Classic	\$84.20
8.701-874.0	092101	Spraybar, 4 Nozzle, Big Guy	\$175.95
8.701-876.0	092102	Spraybar, 2 Nozzle, Big Guy	\$172.85

The Classic

- Portable breakaway handle
- ABS Housing
- 2" nylon brush
- 212°F
- 4-10 GPM
- Dimensions: 19" x 77" x 12"
- Weight: 28 lbs



Part #	Original No.	Description	List Price
8.710-073.0	343605	Whisper Wash Classic	\$1,601.65
8.750-604.0	092110	Swivel, Complete Big Guy and Classic	\$585.04
8.701-879.0	092105	Repair Kit, Seal, Big Guy and Classic	\$84.20

Whisper Wash Flat Surface Cleaners – continued

The Ultra Clean WW

- ABS Housing
- Four 3" casters
- Powder-coated handle
- 185°F
- 3-6 GPM
- 2500 RPM
- Dimensions: 19" x 43" x 9"
- Weight: 23 lbs



Part #	Original No.	Description	List Price
8.710-072.0	343604	Whisper Wash Ultra Clean WW	\$1,150.92

The Ultra Clean HC

- ABS Housing
- 2" nylon brush
- Powder-coated handle
- 185°F
- 3-6 GPM
- Dimensions: 16" x 43" x 9"
- Weight: 19 lbs



Part #	Original No.	Description	List Price
8.710-071.0	343603	Whisper Wash Ultra Clean HC	\$1,022.58

Repair Kits

Part #	Original No.	Description	List Price
8.701-879.0	092105	Seal Kit; Classic, Big Guy and Ground Force	\$84.20
8.701-882.0	092108	Seal Kit; Ultra Clean	\$89.48
8.701-883.0	092109	Complete Swivel Kit; Ultra Clean	\$471.96
8.750-604.0	092110	Complete Swivel Kit; New Style Classic, Big Guy and Ground Force	\$585.04
8.707-653.0	251119	2.5 x 25° 1/4" Nozzle Fits All Models	\$7.04

SideWinder Surface Cleaner



2-Year Mfg.
Warranty

8.739-431.0

- 2000-4000 PSI
- 12 GPM max
- 210°F
- Heavy-duty aluminum handle
- 20" deck
- 19 lbs.

Part #	Original No.	Description	List Price
8.739-431.0	343690	SideWinder 105F Fixed Black	\$1,615.64

Mosmatic Gun Swivel



Mounts to your high-pressure gun or lance for an easy turning, low-maintenance gun swivel



- 4000 PSI
- 250°F
- 30 RPM

Part #	Original No.	Description	List Price
8.712-467.0	421057	1/4" MPT / 1/4" FPT Gun Swivel	\$62.62
8.712-466.0	421056	3/8" MPT / 3/8" FPT Gun Swivel	\$61.49

Mosmatic Surface Cleaners and Duct Cleaner



Turbo Surface Cleaner

Delivers high-pressure performance with low maintenance for any hot or cold pressure washer. Completely stainless-steel design makes this the toughest surface cleaner available in the pressure-cleaning market.



Swiss-engineered with high RPM swivel features reinforced self-lubricated stainless-steel ball bearings and dual spring-based carbide seal bushings for long-lasting operation under tough conditions.

Ideal for pressure washer contractor to clean walls, ceilings, public facilities, tile floors and other hard-to-reach areas. Uses 1/8" meg 1503 nozzles.

- 250°F
- 4000 PSI
- 6.5 lbs.

Duct Cleaner

Designed as an accessory for use with high-pressure pumps or pressure washers. Cleans ducts, chutes, vents, restaurant exhausts, tanks, etc.



Self-rotating and feeding stainless-steel triple bearing system for constant easy turning. Nozzle holders are 1/8" NPTF. Nozzles are sold separately.

- 250°F
- 4000 PSI
- 2 lbs.
- Inlet Ports: 3/8" NPTF

12" Surface Cleaner

Designed for effortless cleaning of small areas, including walls and angled surfaces.

High RPM swivel with integrated toggle joint and adjustable tension system.

- 250°F
- 4000 PSI
- 9 lbs.
- 12" stainless-steel cover



Part #	Original No.	Description	PSI	List Price
8.712-284.0	411171A	Turbo Cleaner – 8"	4000	\$684.14
8.712-285.0	411172	Toggle Joint KGK	4000	\$169.74
8.712-280.0	411156	Duct Cleaner TXR-2s, Adjustable	4000	\$658.26
8.712-279.0	411155	Duct Cleaner TXR-2s, Fixed	4000	\$594.09
8.749-911.0		Surface Cleaner – 12"	4000	\$913.07

Mosmatic Roof Cleaner



Industrial-quality tool specially designed for efficient, high-pressure roof cleaning while keeping the operator in a safe area.

- 21"
- 4000 PSI
- 250°F
- 31.9 lbs.
- Pressure gauge
- Ball valve
- Adjustable wheels (height and width)
- Safety eye connection for rope or cable
- Two 1/8" nozzles sold separately



Part #	Description	List Price
8.749-910.0	Mosmatic Roof Cleaner	\$2,556.45

Undercarriage Cleaner



- No more crawling under a vehicle
- Simply connect to your hot or cold water pressure washer
- Easy to handle and maneuver
- Removes road grime, fuel and oil contaminants
- Removes snow sludge and ice
- Provides a clean, working environment for technicians
- Stainless-steel rotating assembly built to withstand pressures up to 4000 PSI and 250°F
- 5.5" required clearance
- Four Nozzles:
(2) 0° #2.0, (2) 25° #2.0



Part #	Description	List Price
8.749-303.0	Undercarriage Cleaner	\$1,152.57

Oil-Fired Hot Box



Add hot water cleaning economically! Portable water heater add-on for existing cold water pressure washers. Quick Connect to cold water washer, supply fuel and power to Euro-Heat for hot water cleaning applications — USE ONLY WHEN NEEDED and keep the convenience of the portable cold water washer.



- 3000 PSI
- Quick hookup — 3/8" QC inlet / outlet
- Easy service access to burner parts
- Efficient vertical combustion configuration
- Diesel, kerosene, #1 heating oil
- 10" easy-roll tubed pneumatic wheels
- 5-gallon plastic fuel tank
- Compact size — 37" W x 27" L x 39" H
- 36' Ground Fault Interrupter plug
- Thermostat temperature control

Part #	Original No.	Description	List Price
1.103-910.0	HR-5030D	5 GPM / 3000 PSI – 120V	\$3,578.22

Self Serve Underbody Wand Assembly



Ideal for rinsing the undercarriage of cars and trucks. Connect directly to a pressure washer gun or lance. Lightweight, the underbody wand assembly rolls easily giving the operator a long reach.

- Ergonomic lance to reduce bending
- Stainless Steel
- Uses 3 threaded MEG Nozzles
- 3045 PSI
- 212° F
- Inlet 1/4"
- Non-weeping



Part #	Description	List Price
8.755-257.0	Self Serve Underbody Wand Assembly	\$499.00



Goff's Curtain Walls

Build a Power Wash Cell to meet your needs. Goff's Curtain Walls™ increase useable floor space while controlling overspray, contaminants, climate, and noise levels. Curtain Walls™ glide easily on steel track and dual-wheeled rollerhooks. Made from a combination of 14-oz., heavy-duty, reinforced vinyl and double-polished 20-mil clear PVC material. Reinforced hems and chain-weighted lower hems add durability. Hook and loop fasteners on side hems attach to adjacent panels. Meet NFPA-701 requirements for flame retardancy. Curtains are also rot and mildew resistant. Standard model has a white vinyl top, clear PVC center, and blue vinyl bottom.

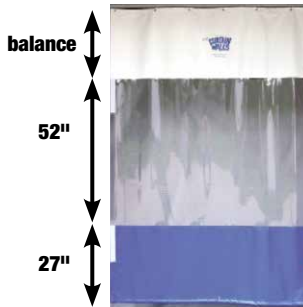

- #2 Brass tooth grommets on 1' centers
- 14 oz. reinforced vinyl white top section
- All seams double-locked stitched
- Hook and Loop Fasteners allow adjacent panels to be easily attached to one another
- 20 mil. double-polished clear window
- All sections joined together using mildew/rot resistant thread
- 14 oz. reinforced colored vinyl section (your choice of over 12 different colors)
- Chain-weighted lower hem

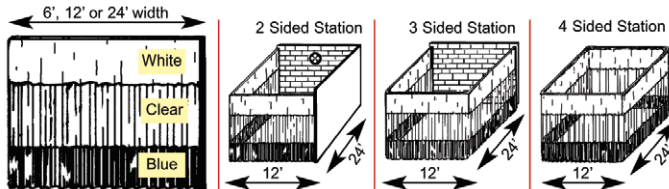

Part #	Original No.	Description	PSI	List Price
Single				
9.841-694.0	681133	6' width x 12' high	1500	\$461.61
8.717-007.0	681083	12' width x 8' high	1500	\$685.17
8.717-008.0	681084	12' width x 9' high	1500	\$697.59
8.739-485.0	681082	12' width x 12' high	1500	\$825.93
8.717-009.0	681086	24' width x 10' high	1500	\$1,372.41
8.739-486.0	681087	24' width x 12' high	1500	\$1,563.89
Station				
9.841-695.0	681145	4-sided x 12' high	1500	\$4,570.56

Includes hardware, track and rollers (white top, clear center and blue bottom panel)
All 2-, 3- and 4-sided stations are 12' wide x 24' long (see diagram above).

Other sizes available — call for details

Water Broom 16"



- 4000 PSI
- Fits any 1/4" wand
- Requires (4) 1/4" nozzles and wand

Part #	Original No.	Description	List Price
8.710-082.0	343615	Water Broom 16"	\$63.91

Professional Sandblast Head



- Long-wearing Carbide sand nozzle
- 1/4" FPT water inlet
- 200°F
- 10 GPM
- 3500 PSI
- Sand probe weight 6 oz, length 16"
- Head weight: 13 oz

Nozzle Size	Part #	Original No.	List Price
3.5	8.711-242.0	391631	\$132.48
4.0	8.711-243.0	391632	\$132.48
4.5	8.711-244.0	391633	\$131.45
5.0	8.904-403.0	391634	\$134.55
5.5	8.711-245.0	391635	\$132.48
6.0	8.904-404.0	391636	\$134.55
8.0	8.711-246.0	391637	\$117.99

Part #	Original No.	Description	List Price
8.711-247.0	391640	Sand Probe	\$15.47
8.901-264.0	121041	1/2" ID Polybraided Tubing, 25'	\$18.99

Sandblast Kit – Carbide Nozzle Industrial Grade



A Venturi orifice creates a uniform blast pattern, doubles sand velocity and produces up to 45% more work with 20% less sand.



- 5500 PSI max working pressure
- 10 GPM max flow
- 200°F
- 10 lbs.
- Nozzle tips sold separately

Part #	Original No.	Description	List Price
8.701-485.0	084079	Sand Blast Kit DWSDBTK	\$209.07

Sandblast Nozzles Tips



Replacement tips for Sandblaster Kit (part no. 8.701-485.0 – Original no. 084079)

- Use 1/4" meg 5° spray tip

Part #	Original No.	Description	List Price
8.707-668.0	251159	4.0 x 5° Tip	\$7.14
8.707-685.0	251198	5.0 x 5° Tip	\$6.99
8.707-696.0	251221	5.5 x 5° Tip	\$7.14
8.707-701.0	251237	6.0 x 5° Tip	\$6.99
8.707-709.0	251256	6.5 x 5° Tip	\$7.09

Sandblast Kit – Carbide Nozzle Industrial Grade



A Venturi orifice creates a uniform blast pattern, doubles sand velocity and produces up to 45% more work with 20% less sand.



8.701-617.0

- Solid carbide blast nozzle
- Venturi orifice design
- Volume control sand feed valve
- Up to 3500 PSI
- Up to 750 lbs. of sand per hour

Kit contents: Sand head with carbide nozzle, 20" lance, sand probe, 13-1/2' sand hose, sand flow regulator valve.

Orifice Size	Part #	Original No.	List Price
4.0	8.904-397.0	391554X	\$372.60
4.5	8.904-396.0	391553X	\$372.60
5.0	8.904-398.0	391555X	\$372.60
5.5	8.904-395.0	391550X	\$372.60
6.0	8.904-399.0	391556X	\$372.60
7.0	8.904-400.0	391557X	\$369.50
10.0	8.904-402.0	391560X	\$372.60

Part #	Original No.	Description	List Price
8.701-620.0	086941	Solid Carbide Nozzle only	\$165.60
8.701-617.0	086930	Probe only	\$75.50

Tip-Jet Nozzles for water nozzle replacement or for system volume changes.

Orifice Size	Part #	Original No.	List Price
3.0	8.708-016.0	253316	\$14.96
4.0	8.708-019.0	253330	\$15.11
4.5	8.708-023.0	253338	\$14.96
5.0	8.708-027.0	253346	\$14.96
5.5	8.708-031.0	253355	\$15.11
6.0	8.708-035.0	253365	\$14.96
6.5	8.708-039.0	253375	\$14.96
7.0	8.708-042.0	253383	\$15.11
7.5	8.708-046.0	253392	\$14.96
8.0	8.708-050.0	253400	\$14.96
9.0	8.708-054.0	253415	\$14.96
10.0	8.708-058.0	253456	\$15.11

Dual-Chemical Systems



- New deep-ribbed yellow casing, stays flexible even in cold temperature
- Hose assembly complete with gun and amphenol connectors pre-wired
- Fully-compatible with Power Blaster, Two-Step, Chemex and most other cold water dual-chemical systems

Part #	Original No.	Description	List Price
Complete Hose Assembly			
8.709-044.0	285116	80' R2 Electric (5 wire)	\$1,357.92
8.709-045.0	285120	100' R2 Electric (5 wire)	\$1,433.12
Lance Attachment Parts			
8.709-049.0	285136	Female Receiver	\$18.58
8.709-050.0	285137	Male Lance Swivel	\$24.53
8.709-051.0	285138	Retainer Nut	\$23.86
Complete Remote Gun Unit			
8.709-046.0	285125	Gun, Electric	\$318.78
Remote Gun / Hose Parts			
8.709-048.0	285135	Gun Housing	\$199.76
8.709-053.0	285139	Switch P/B	\$28.10
8.709-054.0	285140	Switch, Chemical	\$14.49
8.709-056.0	285142	Switch Plate	\$12.58
8.903-083.0	285144	O-ring, Nipple (Two req'd)	\$0.43
8.903-084.0	285145	O-ring, Nipple (Bags of 50)	\$8.95
8.709-060.0	285175	Swivel Adapter	\$11.13
8.709-061.0	285177	Cord Grip	\$28.51
8.709-063.0	285181	Oetiker clamp	\$17.75
8.709-064.0	285187	Switch – Push Button Trigger	\$19.04
8.709-065.0	285189	Toggle, DPDT (Trig) On/Off/On	\$23.75

Stainless-Steel Sewer Nozzles



- 4100 PSI
- Corrosion-resistant stainless-steel
- One forward orifice
- Three rear orifices

Part #	Original No.	FPT	Size	List Price
8.710-905.0	373075	1/8"	5.0	\$17.28
8.710-906.0	373076	1/8"	5.5	\$17.28
8.710-907.0	373077	1/8"	6.0	\$17.44
8.710-908.0	373078	1/4"	6.5	\$18.79
8.710-909.0	373079	1/4"	7.0	\$18.79
8.710-910.0	373080	1/4"	9.5	\$18.94

Sewer/Tube Cleaning Nozzles



The reverse jets on the fixed and rotary nozzles pull the hose through the tube or sewer line and blast debris from line or tube walls.



- Backward ports drive the nozzle forward and flush debris
- Forward ports blast into pipe and breaks up clogs and debris
- Physically small for cornering ability
- 4200 PSI
- Corrosion-resistant stainless-steel construction
- Orifice size indicated on non-rotating styles
- Rotating style adds extra agitation and surface cleaning

Part #	Original No.	Nozzle	Orifice Size	O.D.	Ports	List Price
Non-Rotating Sewer Nozzles						
8.710-875.0	373024	1/8"	4.5	.580"	0-forward, 3 back	\$24.32
8.710-874.0	373023	1/8"	5.5	.580"	1-forward, 3 back	\$24.58
8.710-878.0	373027	1/4"	4.5	.730"	1-forward, 3 back	\$23.07
8.710-876.0	373025	1/4"	5.5	.730"	1-forward, 3 back	\$23.18
8.710-877.0	373026	1/4"	6.0	.730"	1-forward, 4 back	\$24.12
8.710-880.0	373029	1/4"	7.5	.730"	1-forward, 4 back	\$24.58
8.710-879.0	373028	1/4"	8.0	.730"	1-forward, 3 back	\$23.65
8.710-881.0	373032	1/4"	12	.730"	1-forward, 3 back	\$23.39
8.710-885.0	373038	3/8"	4.0	.920"	1-forward, 3 back	\$51.29
8.710-884.0	373037	3/8"	5.5	.920"	1-forward, 3 back	\$49.06
8.710-886.0	373039	3/8"	8.5	.920"	1-forward, 4 back	\$51.54
8.710-883.0	373036	3/8"	12	.920"	1-forward, 4 back	\$50.04
8.710-882.0	373035	3/8"	14	.920"	1-forward, 4 back	\$50.04

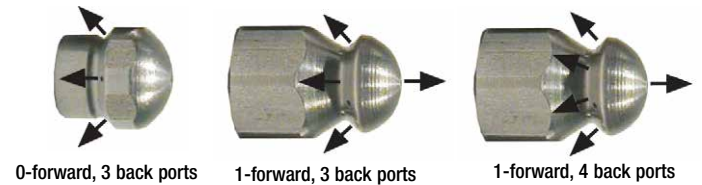

- Rotating sewer nozzle
- Adds extra agitation
- 4000 PSI
- **Back Jet Only**

Part #	Original No.	Rotating Nozzle	Size	Ports	List Price
Rotating Sewer Nozzles					
8.710-899.0	373062	1/8"	5.5	0-forward, 3 back	\$51.39
8.710-898.0	373061	1/4"	5.5	0-forward, 3 back	\$51.65
8.710-900.0	373064	1/4"	8.0	0-forward, 3 back	\$52.16
8.710-887.0	373040	1/4" Duct Clnr*	5.5	0-forward, 2 side	\$50.70

*Duct Cleaner jet to sides instead of reverse

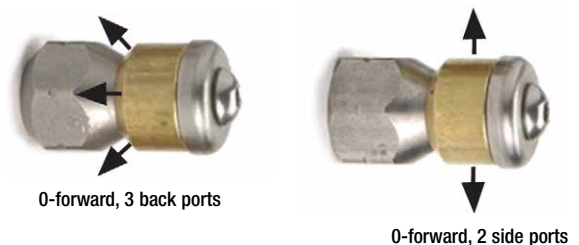

Sewer Hose

SUPER FLEXIBLE SEWER LINE HOSE Hose and couplings have small outside diameter, allowing hose and nozzles to fit through sewer line. Sewer line has Super Tough poly-ether cover over ultra-flexible nylon tube. (1/8" sewer nozzle and hose will operate through many 1-1/2" lines.)
(Nozzles not included.)



- 160°F
- Nylon tube, poly-ether cover

Part #	Original No.	Description	List Price
1/8" hose – 4800 PSI, 1/4" inlet / 1/8" outlet			
8.705-601.0	150960	1/8" x 25'	\$80.37
8.705-602.0	150963	1/8" x 50'	\$108.68
8.705-603.0	150964	1/8" x 100'	\$186.93
1/4" Hose – 2600 PSI, 1/4" inlet / 1/4" outlet			
8.705-607.0	150968	1/4" x 50'	\$78.56
8.705-608.0	150970	1/4" x 100'	\$169.74
1/4" Hose – 4400 PSI, 1/4" inlet / 1/4" outlet			
8.705-610.0	150972	1/4" x 50'	\$110.55
8.705-611.0	150973	1/4" x 100'	\$206.03
8.705-613.0	150975	1/4" x 200'	\$429.14

Foot-Controlled Pressure Valve **SUTTNER**

Operators of sewer and tube cleaning equipment need both hands free to feed or retract the hose in the sewer line. Foot-operated valve allows hands-free control.



- Inlet 3/8" – outlet 1/4"
- Brass body – stainless-steel valve
- Steel cover for safety
- Up to 12 GPM
- Up to 5000 PSI

Part #	Original No.	Description	PSI	List Price
8.710-134.0	344200	Sewer Cleaner Foot Valve	3000	\$137.66
8.709-972.0	342024*	Foot Valve w/ ST-2305	5000	\$345.05
8.701-657.0	089006	Repair Kit – Foot valve		\$20.65
8.701-673.0	089850	Repair Kit ST-2305		\$14.65
8.711-526.0	4-0193	Kit, 25' Hose, #4.5 Nozzle, Foot Valve		\$220.46

*Heavy gauge steel construction for durability and stability

ST-36 Pit Boss Sludge Sucker **SUTTNER**

Sludge Sucker uses a high-pressure water stream (1000-3000 PSI) to suck the sludge off the bottom of pits or tanks and eject it through a 1-1/2" (15' long) hose to a disposal tank.

The base unit attaches to the end of a pressure washer lance with a quick coupler for extension to the bottom of the pit. Uses a 0° tip for suction / power ejection.



- Uses standard 1/4" MPT nozzle
- Easy to change for different plumbing system flows and pressures

Part #	Original No.	Description	List Price
8.711-112.0	376137	ST-35 Pit Boss, 5.5 Nozzle / 15' Hose	\$182.16
8.711-110.0	376126	(Base unit only)	\$105.57

*w/o hose, nozzle or quick coupler (3/8" inlet port)

Drum Tool Accessories

The indispensable tools.



8.712-534.0



8.704-691.0



8.704-689.0



8.707-474.0



8.704-692.0

Part #	Orig. No.	Description	List Price
8.712-534.0	449339	Drum Plug Wrench	\$30.02
8.704-689.0	118400	Lid-Off	\$11.64
8.704-691.0	118404	Funnel, 7" x 10"	\$22.77
8.704-692.0	118407	3/4" Faucet	\$4.97
8.704-693.0	118408	2" Faucet	\$43.16

Load Cincher Tie Downs

8.707-473.0	249938	7/8" x 5-1/2' (Non-Ratchet) "Quick Lock"	\$10.30
8.707-474.0	249939	1" x 15' (Ratchet) "Tight Lock"	\$19.11



Fiberglass "Super Handles"



- Tough, durable, lightweight
- No cracking, splintering
- No kinks, dents
- Safer around electrical hazards
- Easy-twist cam lock extension
- Super heavy-duty aluminum alloy threads
- Standard 3/4" Acme thread fits: brooms, brushes, utility tools
- Optional reduction adapter for 3/4" to Acme standard

Part #	Original No.	Description	List Price
Super Handles			
8.709-306.0	306864	48" Length (4 ft.)	\$21.79
8.709-307.0	306865	60" Length (5 ft.)	\$23.70
8.709-308.0	306866	72" Length (6 ft.)	\$27.32
Super-Extension Handles			
8.709-309.0	306868	4 ft. to 8 ft. Ext.	\$51.13
8.709-310.0	306869	6 ft. to 12 ft. Ext.	\$65.83
8.709-311.0	306870	8 ft. to 16 ft. Ext.	\$83.37
8.700-308.0	075271	Threaded Adapter	\$3.98

Drum / Tank Pump – Crank Type

Chemical-resistant, lightweight pump, ideal for dispensing chemicals, pesticides and oils. **Polypropylene** for most alkalies, dilute acids, pesticides, and most oils and solvents. **Ryton** for extremely aggressive acids, aromatic and aliphatic hydrocarbons.



SPECIFICATION:

- 11 oz per revolution
- 6 GPM @ 70 RPM
- Viton seals
- Polypropylene gasket
- 2" bung adapter
- Outlet 3/4" barb two-piece
- 47" suction tube
- Weight: 2.6 lbs

Part #	Original No.	Description	List Price
8.704-700.0	118435	Polypropylene Pump (Standard)	\$178.02
8.704-701.0	118438	Ryton Pump (Deluxe)	\$261.86
8.700-526.0	076975	Replacement Handles	\$19.61

Siphon Pumps

Siphon liquids from higher to lower levels. Simply pump the bellows a few times to prime and start flow. Loosen air lock to stop.



- Drum pump fits 15-, 30- and 55-gallon drums
- Fit 2" bung opening
- Excellent for alkaline and acidic chemicals, diesel fuel, and oils
- Not for use with solvents!

Part #	Original No.	Description	List Price
8.704-698.0	118429	Red Hex Head (Heavy-duty)	\$19.62
8.704-696.0	118423	Red Head (Standard duty)	\$19.88
8.704-694.0	118420	Pail Pump (5 Gallon)	\$9.78

Brushes

Rotating Brush – Natural Bristle (soft) used for painted surfaces. Nylon Bristle (stiff) used for removing scum and grime on fiberglass boats, etc.



- Internal nozzle = size 20
- 8 GPM

Part #	Original No.	Description	List Price
Brush Unit Complete			
8.709-312.0	306925	Natural	\$70.39
8.709-314.0	306935	Nylon	\$61.19
Replacement Brushes			
8.709-313.0	306927	Natural	\$34.10
8.709-316.0	306937	Nylon	\$32.81

Truck Wash Brush



- Flag-tipped
- Soft bristle
- ACME thread for Super Handles, or broom handles

Part #	Original No.	Description	List Price
8.709-298.0	306800	2-1/2" Bristle w/ Bumper x 10"	\$24.94
8.709-303.0	306818	2-1/2" Bristle x 18"	\$24.48
8.709-304.0	306824	2-1/2" Bristle x 24"	\$29.34
8.709-305.0	306860	60" Flow Thru Lance*	\$30.43

*with Acme Thread and Garden Hose Attachment

Deck Scrub Brush – Over / Under

Unique heavy-duty scrub brush with multi-level / angle.



- Trimmed for cleaning hard-to-reach areas
- 10" molded polypropylene foam block does not warp or absorb water
- Stiff polypropylene bristle for aggressive cleaning
- Excellent chemical resistance
- Use with threaded handle
- Not a Flow Thru

Part #	Original No.	Description	List Price
8.709-302.0	306812	Deck Scrub Brush	\$24.12

Tractor Brush – Soft for gentle cleaning of fine finishes.



Part #	Original No.	Description	List Price
8.709-300.0	306802	Flag Tip Window 10"	\$20.24

Compact Foamer

Generates a high-density clinging foam for extended dwell-time to increase chemical action.



- Stainless-steel, aluminum and brass
- 5" long, 1" diameter
- 4 and 6.5 nozzle included
- 1 to 5 GPM
- 195°F
- 2500 PSI

Part #	Original No.	Description	List Price
8.903-998.0	344022V	1/8" F Inlet	\$60.96
8.903-999.0	344023V	1/4" F Inlet	\$56.20

NOTE: Most cleaning chemicals perform best when applied at 120°-150°F and can be applied as a foam by adding a foaming agent. See your chemical supplier to obtain the correct product.

Foam Cannon

The ideal Foam Generator Application Accessory meters the foaming chemical for customized foam type and applies the foam to match the application.



- Stainless-steel 1.5mm orifice (#5.5 nozzle equivalent)
- Brass meter valve
- 3000 PSI max pressure
- High-impact, glass-filled body
- 4.8 GPM max flow
- Stainless-Steel Foam Turbulator
- 176°F max temperature
- 1/4" FPT lance connect

Part #	Original No.	Description	List Price
8.710-125.0	344030	Foam Cannon / Injector	\$99.60
8.710-126.0	344032	Foam Cannon / Injector / Bottle	\$118.45
8.704-222.0	113011	Replacement Turbulator Screen	\$17.18

Air-Power Sprayers



- Pump-up style
- Heavy-duty plastic sprayers for chemical applications
- Both models have Adj. Nozzle — from mist to solid stream
- 2-gallon unit has 2' hose and hand trigger
- Excellent chemical resistance
- Locking hand pump handle serves as carrying handle

Part #	Original No.	Description	List Price
8.704-703.0	118842	Thumb Button 3 Pint	\$36.02
8.704-702.0	118835	2-Gallon Sprayer	\$79.80

Legacy

Foam Jet Kit

Long-distance foam applicator. Shoots OVER 20 FEET of dense foam. Suction at 30 feet of height. Variable spray pattern.



- 5000 PSI
- 5.6 GPM
- 14" inlet
- 140°F
- 33' Tube

Part #	Description	List Price
8.750-296.0*	Kit, Foam Jet, 5000 PSI, 5.6 GPM	\$128.34
8.750-429.0	Kit, Repair, Foam Jet Orings / Stainless-Steel Filter	\$16.77
8.750-430.0	Kit, Repair, Foam Jet, Hose / Valve / Filter	\$49.89

* Includes tubing and fittings as shown

Lafferty Airless Foam Kit



Includes:

- Machined stainless-steel construction
- Stainless-steel chemical check valve
- Stainless-steel quick disconnects
- 10' chemical tube with strainer
- Color-coded metering tips for up to 21 dilution ratios
- 0° nozzle for increased foam-throw distance

Part #	Water Flow Rate	@2000 PSI	@ 137.9 bar	List Price
8.749-908.0	Model 10	4.0 GPM	15.1 LPM	\$583.74
8.749-909.0	Model 20	6.0 GPM	22.7 LPM	\$573.39

Adjustable Foamer with Tank

Control the foam spray angle with the variable fan nozzle.



- Horizontal variable fan nozzle
- Foam control adjustment knob
- PSI: 2600
- GPM: 5.3
- 140°F

Part #	Description	List Price
8.710-124.0	Adjustable Foamer w/ Tank	\$100.84

Thread Lock Products



- Direct replacement for Loctite® and Fel-Pro™ products
- ND™ anaerobic adhesives are liquid materials that cure to a solid, chemical-resistant plastic state when air is not present
- Excellent lubricant; prevents corrosion and fretting

Part #	Original No.	Description	Loctite® Equiv	Bottle Size	List Price
8.704-644.0	112350	Nut Grade™	242	10 ml	\$15.37
8.704-645.0	112352	Nut Grade™	242	50 ml	\$46.73
8.704-646.0	112354	Nut Grade™	242	250 ml	\$154.22
8.704-648.0	112360	Stud Grade™	271	10 ml	\$15.89
8.704-649.0	112362	Stud Grade™	271	50 ml	\$46.68
8.704-650.0	112367	Penetrating Adhesive (Sealant)	290	10 ml	\$15.58

Nut Grade™ and Stud Grade™ are trademarks of the Oakland Corp. Loctite® is a registered trademark of the Loctite Corp.

Gloves – Industrial Duty

Industrial-grade gloves for most industry-needs — chemical / heat / abrasion / laceration protection.



- 8.704-669.0** Black, 14" PVC glove lined with cotton for the most demanding chemical handling. Resists alkalines, acids — even works well as a sandblasting glove.

- 8.704-668.0** Gray – Split Cowhide work gloves, 2-1/2" gauntlet unlined — great general purpose work glove.

Part #	Original No.	Description	List Price
8.704-668.0	116105	Gray Roughout	\$11.44
8.704-669.0	116114	Black PVC	\$9.32

Rain Suit – 2-Piece



- Heavy-duty, 2-ply laminated vinyl (25 mil)
- Jacket and pants
- Bright safety yellow
- Vented for air flow

Part #	Original No.	Description	List Price
8.704-666.0	116100	Large	\$24.27
8.704-667.0	116101	Extra Large	\$24.37

Amazing Pocket Reference – Third Edition

A ton of information in a 5 oz book!

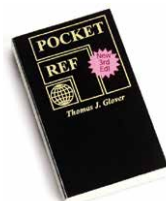

- Air and gases
- Automotive
- Chemistry
- Electrical
- Physical constants
- Math
- 3350 conversion factors
- Plumbing and pipe
- Over 20 other subject areas

Part #	Original No.	Description	List Price
8.712-505.0	449015	Pocket Reference	\$24.12

Shipping Tape and Dispenser

Big 2" x 110 yard rolls of clear. Biaxially-oriented polypropylene for secure packages.



- Heavy-duty tape dispenser with serrated blade

Part #	Original No.	Description	List Price
8.704-707.0	118916	Dispenser Boxed	\$28.31
8.901-249.0	118918	110 Yard Roll	\$4.97

Teflon® Thread Sealing Tape



- Big 1/2" x 520' roll
- Mil — spec #T27730

Part #	Original No.	Description	List Price
8.704-705.0	118905	Thread Sealing Tape	\$1.13

Profit From Power Washing

Geared specifically to determining the profitability, feasibility, and marketability of owning a pressure washing business. It covers the methodology so crucial in both starting and operating a pressure washing service. Topics covered include:

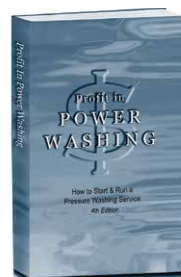

- Marketable services
- Equipment selection
- Equipment use
- Personal safety
- Target markets
- Customer relations
- Estimating
- Advertising
- Chemical selection and use
- Important legal issues
- Much more...

Part #	Description	List Price
8.750-507.0	Profit From Power Washing	\$30.89

Yamada Pumps



8.702-180.0



8.702-183.0

Air-powered double diaphragm pump, "Reliable Performance Since 1905". The answer to difficult product transfer problems. Air-drive allows freedom from electrical hazards or explosion-proof motor requirements. Choose from various wetted-parts materials to customize the pump to the chemical being pumped. Yamada's smaller pumps are often used for pumping car wash chemical for 'low-pressure' functions. The 1/2" pump is also ideal for rapidly pumping oil, soap, etc., from 55 gallon barrels. Larger pumps are used for high-volume product transfer. Since all pumps are designed without rotating parts, they can also handle abrasive liquids such as ceramic slip, sand slurry, or enamel frit without damage.

Have a unique challenge? Call us for help!

- Environmentally-friendly non-lube air valve
- Automatic start/stop
- Infinitely variable flow control regulated by opening or closing discharge side valve and/or fluctuating air supply
- Non-stalling air valve — positive switching every stroke and won't ice up
- Outside accessible air valve — easy inspection and maintenance
- Bolted flange connections — leak-free and easy maintenance
- Built-in abrasion and chemical-resistance
- Virgin diaphragm materials last twice as long as other pumps
- 100 PSI
- 180°F
- 1/4" model deliver 3.4 GPM with 20-100 PSI drive air
- 1/2" models deliver 15 GPM with 20-100 PSI drive air
- 3/4" models deliver 19.5 to 27.3 GPM with 20-100 PSI drive air
- 1" models deliver 35.7 to 48.3 GPM with 20-100 PSI drive air

Part #	Old No.	Intake and Discharge	Air Inlet w/ball valve	Air Exhaust w/B-1 muffed	Pump Body	Diaphragm Material	Max Flow @ 100 PSI	Max Solid	List Price
8.702-180.0	100381	1/4" FPT	1/4" FPT	3/8" FPT	Poly	Teflon®	3.4 GPM	N/A	\$575.46
8.702-181.0	100382	1/4" FPT	1/4" FPT	3/8" FPT	Kyn	Teflon®	3 GPM	N/A	\$1,261.67
8.702-200.0	100410	3/8" FPT	1/4" FPT	3/8" FPT	Poly	Teflon®	6 GPM	1/32"	\$822.83
8.702-201.0	100411	3/8" FPT	1/4" FPT	3/8" FPT	Poly	Santoprene®	6 GPM	1/32"	\$716.22
8.702-182.0	100383	1/2" FPT	1/4" FPT	3/8" FPT	Poly	Hytrel®	15 GPM	1/32"	\$738.99
8.702-183.0	100384	1/2" FPT	1/4" FPT	3/8" FPT	Poly	Santoprene®	15 GPM	1/32"	\$728.64
8.702-184.0	100385	1/2" FPT	1/4" FPT	3/8" FPT	Poly	Teflon®	15 GPM	1/32"	\$791.78
8.702-187.0	100391	3/4" FPT	1/4" FPT	3/4" FPT	Poly	Neoprene	27.3 GPM	1/16"	\$2,416.73
8.702-188.0	100392	3/4" FPT	1/4" FPT	3/4" FPT	Poly	Buna-N	27.3 GPM	1/16"	\$1,524.56
8.702-189.0	100393	3/4" FPT	1/4" FPT	3/4" FPT	Poly	Hytrel®	27.3 GPM	1/16"	\$1,320.66
8.702-190.0	100394	3/4" FPT	1/4" FPT	3/4" FPT	Poly	Teflon®	27.3 GPM	1/16"	\$1,611.50
8.702-191.0	100395	3/4" FPT	1/4" FPT	3/4" FPT	Alum	Buna-N	27.3 GPM	1/16"	\$1,277.19
8.702-192.0	100396	1" FPT	3/8" FPT*	3/4" FPT	Poly	Neoprene	48.3 GPM	3/16"	\$1,884.74
8.702-193.0	100397	1" FPT	3/8" FPT*	3/4" FPT	Poly	Hytrel®	48.3 GPM	3/16"	\$1,751.22
8.702-194.0	100398	1" FPT	3/8" FPT*	3/4" FPT	Poly	Teflon®	48.3 GPM	3/16"	\$1,960.29
8.702-195.0	100399	1" FPT	3/8" FPT*	3/4" FPT	Alum	Hytrel®	35.7 GPM	3/16"	\$1,432.44
8.702-202.0	100415	1-1/2" FPT	1/2" FPT*	3/4" FPT	Alum	Buna-N	116 GPM	9/32"	\$1,917.86

*With air-cock instead of ball valve

Diaphragm Kits for Yamada Pumps



To minimize downtime, Yamada pumps are designed for quick, trouble-free maintenance. Pump diaphragms, balls and seats can be replaced in 20 minutes or less and with little chance of leaks commonly associated with other diaphragm pumps.

- Kits include everything required for routine maintenance

Part #	Old No.	Kit	Pump Size	Yamada Pump No.	List Price
8.703-277.0	105004	Teflon®	1/4"	100381	\$131.45
8.703-278.0	105006	Hytrel®	1/2"	100383	\$159.39
8.703-279.0	105008	Santoprene	1/2"	100384	\$153.18
8.703-281.0	105010	Teflon®	1/2"	100385	\$229.77
8.703-282.0	105012	Neoprene	3/4"	100391	\$200.79
8.703-283.0	105014	Buna-N	3/4"	100392	\$183.20

Part #	Old No.	Kit	Pump Size	Yamada Pump No.	List Price
8.932-947.0	105018	Teflon®	3/4"	100394	\$617.90
8.703-284.0	105022	Neoprene	1"	100396	\$205.97
8.703-285.0	105024	Hytrel®	1"	100397	\$269.10
8.703-286.0	105026	Teflon®	1"	100398	\$828.00
8.703-320.0	105150	Buna	1-1/2"	100415	\$282.56

NOTE: Individual components (O-rings or diaphragms only, for example) also available. Call for pricing and delivery.

Air-Operated Pump

FLOJET

Twin diaphragm, self-priming, 7.0 GPM.



- Santoprene elastomers
- Dry air (or CO2) 20-120 PSI
- 7.0 GPM
- 120°F max liquid temperature
- Self-priming up to 15 feet
- Air (gas) in and out, 1/4" barb
- Choice of 3/8" or 1/2" barb fluid in/out
- Automatic, on-demand start and stop
- Flow control via air (gas) pressure
- Common uses: chemical transfer and dispensing parts, washers, and car wash systems

Part No.	Original No.	Description	List Price
8.702-321.0	100874	3/8" Pump (Santoprene)	\$243.08
8.702-322.0	100874A	3/8" Pump (Viton)	\$371.57
8.702-323.0	100875	1/2" Pump (Santoprene)	\$245.30
8.702-324.0	100875A	1/2" Pump (Viton)	\$345.69

Air-Driven Pump

FLOJET

Twin diaphragm, self-priming, 1.9 GPM.



- Santoprene or Viton elastomers: Use Santoprene for soaps, use Viton for butyls
- Dry air (or CO2) 20-80 PSI
- 1.9 GPM
- Chemical in and out, 3/8" barb
- Air (gas) in and out, 1/4" barb
- Automatic, on-demand start and stop
- Control flow and pressure with air pressure

Part #	Old No.	Description	List Price
8.702-320.0	100873	Pump (Santoprene)	\$181.13
8.702-319.0	100872	Pump (Viton)	\$221.49
8.700-387.0	075862	Diaphragm Kit (Santoprene)	\$24.17
8.700-388.0	075863	Valve Kit (Santoprene)	\$30.43
8.700-418.0	075907	Diaphragm Kit (Viton)	\$61.27
8.700-419.0	075908	Valve Kit (Viton)	\$38.45

Air Filter / Regulators



8.712-585.0



8.712-586.0

- Maintains and gauges pressure to, and therefore discharges pressure from, air-driven diaphragm pumps
- Removes air line impurities to 5 microns
- 1/4" ports
- 125 PSI
- Pressure-relieving

Part #	Old No.	Description	List Price
8.712-585.0	462280	Regulator Only	\$48.44
8.712-586.0	462285	Filter/Regulator	\$108.68
8.712-587.0	462290	Gauge, 0-1 60, 1/8"	\$9.11

Foam Brush and Accessories



Foam Brush Head

3" x 10" supersoft flagged bristle fountain brush. Choose from black, red or blue.



Foam Brush Lance

40" long with 30" insulated grip, 3/8" FPT inlet, 1/2" MPT outlet (matches brush inlet). Colors: red, blue, or black.



Brush Hoses

Clear, spiral wire braid, 1/2" ID with 3/8" MPT, zinc-plated steel fittings both ends.

Part #	Old No.	Description	List Price
8.710-115.0	344006	Foam Brush Head, Black	\$47.56
8.710-117.0	344006RED	Foam Brush Head, Red	\$50.46
8.710-116.0	344006BLU	Foam Brush Head, Blue	\$49.52
8.710-118.0	344010	Foam Hose (12')	\$59.15
8.710-119.0	344011	Foam Hose (15')	\$74.16
8.710-121.0	344014	Lance 40", Red	\$29.24
8.710-122.0	344014BLK	Lance 40", Black	\$30.12
8.710-123.0	344014BLU	Lance 40", Blue	\$28.36

CAR WASH BAY ACCESSORIES

“Reflex” Car Wash Booms

The performance leader!



- 5'6" car wash model
- 8' truck wash model
- 3000 PSI
- Stainless-steel boom arm
- 3/8" FPT inlet/outlet hose included

Part #	Old No.	Description	List Price
Booms			
8.903-620.0	306660X	180° Wall Mount 5'6" Boom	\$460.41
8.903-621.0	306662X	360° Ceiling Mount 5'6" Boom	\$468.65
8.903-624.0	306665X	180° Wall Mount 10' Boom	\$594.09
8.903-625.0	306666X	360° Ceiling Mount 10' Boom	\$610.65
8.903-626.0	306667X	180° Wall Mount 8' Boom	\$586.85
8.903-627.0	306668X	360° Ceiling Mount 8' Boom	\$601.34
Parts / Accessories			
8.903-622.0	306663X	5.5' Rod/Hose, Assy Only	\$274.28
8.903-623.0	306664X	8' Rod/Hose, Assy Only	\$371.57
8.903-628.0	306669X	10' Rod/Hose, Assy Only	\$387.09
8.903-630.0	306670X	Ceiling Mount, Base Only	\$449.19
8.903-632.0	306672X	Wall Mount, Base Only	\$434.70
8.700-265.0	075064X	Set Screw for Angle Block	\$1.15
8.905-605.0	568612	90° End Coupler C/W Boom	\$48.02
8.905-604.0	568610	8' Coupler Stainless-Steel C/W Boom	\$35.03
8.712-450.0	421020	Swivel – Brass 3/8"	\$39.02
8.700-263.0	075060	Swivel Repair Kit (pre-1998)	\$15.55
8.700-287.0	075130	Swivel Repair Kit (1998-present)	\$26.55

Stainless-Steel Bay Accessories

Foam brush boom holder, wand holders, mat clamps.



Part #	Old No.	Description	List Price
8.708-880.0	260600	Standard Foam Brush Holder	\$28.63
8.708-881.0	260605	Rigid Wall Mount Wand Holder	\$72.05
8.708-882.0	260606	Flex Bottom Mount Wand Holder	\$159.39
8.708-883.0	260610	Mat Clamp	\$26.29

Locks for Meter Boxes



Part #	Old No.	Description	List Price
8.708-731.0	260064	Disk Lock (Master Brand)	\$33.53
8.708-730.0	260062	Tubular Cam Lock	\$42.80

8-Position Rotary Switch

Metal car wash switch.



- Much more durable than cheaper plastic switches
- Direct replacement for Electroswitch 31302A-S and NU32LA
- Make before break functions
- Double stack 8-position
- Metal

Part #	Old No.	Description	List Price
8.708-729.0	260061	8-Position Rotary Switch	\$75.81

Transformers



Part #	Old No.	Description	List Price
8.708-780.0	260311	115-24V AC: 600 MIL/AMP	\$45.75
8.708-781.0	260312	115/208/230-24V AC: 100V A Fused	\$117.11
8.708-783.0	260315	120/208/240-24V AC: 50V A	\$40.11
8.708-784.0	260316	120/208/240- 24V A Not Fused	\$24.27

Fuses



Part #	Old No.	Description	List Price
8.708-786.0	260324	Transformer fuse 5 Amp (For P/N 260312)	\$9.26

Medium-Pressure Swivels



- 1000 PSI
- 7/16" flow-thru opening
- All-brass body
- Bronze-thrust bearing
- Buna-N seals (non-repairable)
- 1/2" FPT x 1/2" MPT

Part #	Old No.	Description	List Price
8.705-057.0	140094	Swivel	\$25.88

Low-Pressure Swivels



- 300 PSI swivel action
- Brass MPT
- Zinc-chromate steel FPT

Part #	Old No.	Description	List Price
8.705-054.0	140085	1/4" x 1/4"	\$5.69
8.705-056.0	140087	3/8" x 3/8"	\$11.54
8.705-055.0	140086	1/2" x 1/2"	\$13.56

Flex Lances



- Flexes 180° and returns
- Prevents bent lances and broken hoses
- Industrial-grade polyurethane flex section
- Perfect for self-serve car wash bays
- 1/4" galvanized pipe end sections
- 2500 PSI
- 200°F

Part #	Old No.	Length/Color	Description	List Price
8.710-600.0	368119BLK	18" Black	1/4" MPT x 1/8" FPT	\$40.99
8.710-601.0	368119BLU	18" Blue	1/4" MPT x 1/8" FPT	\$42.64
8.710-603.0	368121	21" Red	1/4" MPT x 1/8" FPT	\$42.85
8.710-604.0	368124	24" Red	1/4" MPT x 1/8" FPT	\$44.35
8.710-598.0	368118	18" Red	1/4" MPT x 1/4" MPT	\$30.23

RB65 Wash Gun



Low-pressure spray gun with straight jet and adjustable cone from the trigger with adjustable screws to alter cone angle wideness from 0° to 60°.



- Completely sealed
- Ergonomic
- Adjustable jet cone
- Trigger protection
- Brass body
- Inlet connection swivel
- 16 GPM
- 350 PSI-rated pressure
- 195°F

Part #	Old No.	Description	List Price
8.710-449.0	353265	PA RB65 w/ Awivel	\$155.53
8.710-448.0	353264	PA RB65 No Swivel	\$131.84

Car Wash Vacuum Hose CW150 and CW200

ULTIMATE
CRUSH-PROOF

The most flexible, easy-to-handle vacuum hose ever!



- Recovers immediately from crush
- Tough and durable
- Resists ultraviolet rays and abrasion
- Smooth interior bore for max air flow
- CW150 = 1-1/2"; CW200 = 2"

Part #	Old No.	Size	List Price
8.708-912.0	260957	1.5" x 12.5'	\$23.60
8.708-907.0	260950	1.5" x 15'	\$30.48
8.708-909.0	260954	1.5" x 25'	\$43.88
8.708-910.0	260956	1.5" x 50'	\$86.63
8.708-917.0	260962	2" x 15'	\$44.66
8.708-919.0	260966	2" x 25'	\$82.18
8.708-920.0	260968	2" x 50'	\$159.84

Vacuum Accessories

May slip directly on to hose. Use with swivel cuffs for better results.

Vacuum Claw Nozzle



Part # 1-1/2"	Old No. - 1-1/2"	Part # 2"	Old No. - 2"	Color	List Price
8.708-893.0	260917	8.708-895.0	260919	Orange	\$5.64
8.708-892.0	260916	8.708-894.0	260918	Yellow	\$6.47
8.708-891.0	260915	8.708-897.0	260921	Black	\$5.80
8.708-890.0	260914	8.708-899.0	260923	Gray	\$5.80

Couplings

Part #	Old No.	Description	List Price
8.708-896.0	260920	1-1/2"	\$6.37
8.708-898.0	260922	2"	\$6.88

Adapter



Part #	Old No.	Description	List Price
8.708-900.0	260924	2" Hose x 1-1/2" Wand	\$7.40
8.708-904.0	260942	2" Hose x 2" Wand	\$6.57

Vacuum Nozzles



Part #	Old No.	Description	Degree	List Price
8.708-901.0	260932	1-1/2" x 1-1/2" x 5-1/4"	45°	\$6.00
8.708-902.0	260934	2" x 2" x 5-1/2"	45°	\$8.75

Cuffs, Hose to Tank



Part #	Old No.	Description	List Price
8.708-903.0	260940	1-1/2" x 1-1/2"	\$4.24
8.708-904.0	260942	2" x 2"	\$6.57
8.708-905.0	260944	1-1/2" x 1-1/2" Swivel	\$3.78
8.708-906.0	260946	2" x 2" Swivel	\$6.83

CAR WASH BAY ACCESSORIES

AP Vacuum Motors



8.625-841.0



8.620-204.0



8.625-842.0

Part #	Description	List Price
Two Fan Stages, Bypass Motors		
8.625-841.0	5.7" Diameter, 120V Double Ball Bearing Peripheral Discharge	\$91.12
8.620-204.0	Vault system Vac Motor: 120V Double Ball Bearings, Tangent Discharge	\$92.52
Three Fan Stages, Bypass Motors		
8.625-842.0	5.7" Diameter, 120V Double Ball Bearings Tangent Discharge	\$121.84

Ametek-Lamb Vacuum Motors



8.685-502.0



8.685-442.0



8.685-458.0

Part #	Description	List Price
Two Fan Stages, Bypass Motors		
8.685-502.0	5.7" Diameter, 120V Double Ball Bearing Peripheral Discharge	\$90.75
8.685-442.0	Vault system Vac Motor: 120V Double Ball Bearings, Tangent Discharge	\$98.32
Three Fan Stages, Bypass Motors		
8.685-458.0	5.7" Diameter, 120V Double Ball Bearings Tangent Discharge	\$166.56

Connector Hose / Car Wash Bay Hose – 12'-25'

All car wash bay hoses come with solid male pipe on both ends.



Part #	Length	List Price
3/8" Ultima – 1 wire 3000 PSI		
8.918-333.0	12'	\$30.22
8.918-334.0	13'	\$31.57
8.918-336.0	14'	\$34.21
8.918-338.0	15'	\$36.02
8.918-340.0	16'	\$37.10
8.918-342.0	17'	\$39.80
8.918-344.0	18'	\$41.66
8.918-346.0	19'	\$38.40
8.918-348.0	20'	\$45.07
8.918-350.0	21'	\$47.04
8.918-352.0	22'	\$43.21
8.918-354.0	23'	\$44.87
8.918-356.0	24'	\$46.58
8.918-358.0	25'	\$54.65

Part #	Length	List Price
3/8" Blue – 1 wire 3000 PSI		
8.918-360.0	12'	\$37.10
8.918-362.0	13'	\$42.64
8.918-364.0	14'	\$41.30
8.918-366.0	15'	\$43.63
8.919-124.0	16'	\$47.61
8.918-369.0	17'	\$52.73
8.918-371.0	18'	\$50.66
8.918-373.0	19'	\$53.04
8.918-375.0	20'	\$55.42
8.918-377.0	21'	\$57.75
8.918-379.0	22'	\$60.13
8.918-381.0	23'	\$67.79
8.918-383.0	24'	\$64.84
8.918-385.0	25'	\$72.86

Part #	Length	List Price
1/4" Ultima – 1 wire 3000 PSI		
8.918-306.0	12'	\$26.65
8.918-308.0	13'	\$24.12
8.918-310.0	14'	\$28.88
8.918-312.0	15'	\$30.48
8.918-314.0	16'	\$32.03
8.918-316.0	17'	\$33.64
8.918-318.0	18'	\$35.19
8.918-320.0	19'	\$32.45
8.918-322.0	20'	\$38.35
8.918-324.0	21'	\$39.95
8.918-325.0	22'	\$36.64
8.918-327.0	23'	\$38.04
8.918-329.0	24'	\$44.66
8.918-331.0	25'	\$40.83

Part #	Length	List Price
1/4" Blue – 1 wire 3000 PSI		
8.918-387.0	12'	\$37.00
8.918-389.0	13'	\$37.42
8.918-391.0	14'	\$41.61
8.918-393.0	15'	\$41.92
8.918-395.0	16'	\$46.16
8.918-397.0	17'	\$46.47
8.918-399.0	18'	\$48.75
8.918-401.0	19'	\$50.97
8.918-403.0	20'	\$53.30
8.918-405.0	21'	\$55.58
8.918-407.0	22'	\$57.86
8.918-409.0	23'	\$60.13
8.918-411.0	24'	\$62.36
8.918-413.0	25'	\$64.69



Solenoid Valves

Dependable, cost-effective solutions to valve challenges.

Suitable for:

- Air
- Light oil
- Professional car washes
- Chemicals
- Low pressure steam
- Other industrial applications



Water Solenoid Valves 2-way, normally closed.
The S211 Series Standard Water Valves have reliable piloted diaphragm construction with proven performance over decades of use. Featuring stainless-steel seats, the S211 Series typically requires 4 or 5 PSI pressure differential to open. The S201 Series Zero Differential Valves are constructed with the same materials, but are capable of operating with the same amount of pressure on both sides of the valve. Both valve types are often utilized in the car wash industry.



Chemical Solenoid Valves 2-way, normally closed.
For decades, car wash industry professionals have chosen the rugged S301 and S311 Series Valves because of their compact size and long life. Available in 1/8", 1/4" and 3/8" NPT designs, these valves are used in air, water and chemical applications.



High-pressure Solenoid Valves 2-way, normally closed.
The S401 High-Pressure Valves are compact, dependable and specially designed by ITT to meet car wash applications up to 1400 PSI. **Best Buy**

Normally Open Solenoid Valves for Car Wash Anti-Freeze Applications.
These valves provide long life and reliable performance in the "make or break" anti-freeze systems of car washes. The S202 and S212 Series Diaphragm Valves feature non-wicking, fabric-reinforced diaphragms, which eliminates premature diaphragm failures, as well as stainless-steel upper seats, which prevents seat deterioration often associated with brass-seated valves. The S202 Series Diaphragm Valve incorporates the zero-operating pressure design discussed above; the S212 Series is a piloted diaphragm, and the S402 Series is a piloted piston valve.

Solenoid Valve Specifications – continues on to page 140

Body
BR = Brass
SS = Stainless-steel

Seals
B = Buna
V = Viton

Mode
N/O = Normally Open
N/C = Normally Closed

Type
PD = Piloted Diaphragm
PP = Piloted Piston
DA = Direct Acting



Part #	Old No.	GC Part No. Series	Port F-NPT	Body	Orifice	Oper PSI	Seals	Mode	Type	AC Volts	DEMA Equiv	List Price
8.708-805.0	260450	S201-CG4	3/8"	BR	.312"	150	B	N/C	PD	24	A413P-24	\$157.32
8.708-806.0	260451	S201-CG4	3/8"	BR	.312"	150	B	N/C	PD	110	A413P-110	\$157.32
8.708-807.0	260452	S201-DG4	1/2"	BR	.438"	150	B	N/C	PD	24	A414P-24	\$140.76
8.708-808.0	260453	S201-DG4	1/2"	BR	.438"	150	B	N/C	PD	110	A414P-110	\$143.87
8.708-810.0	260454	S201-EG5	3/4"	BR	.593"	150	B	N/C	PD	24	A416P-24	\$181.13
8.708-811.0	260455	S201-EG5	3/4"	BR	.593"	150	B	N/C	PD	110	A416P-110	\$181.13
8.708-812.0	260456	S201-FG9	1"	BR	.760"	150	B	N/C	PD	24	A418P-24	\$281.52
8.708-813.0	260457	S201-FG9	1"	BR	.760"	150	B	N/C	PD	110	A418P-110	\$244.26
8.708-820.0	260464	S211-CG4	3/8"	BR	.625"	150	B	N/C	PD	24	473P-24	\$140.76
8.708-821.0	260465	S211-CG4	3/8"	BR	.625"	150	B	N/C	PD	110	473P-110	\$139.73
8.708-822.0	260466	S211-DG4	1/2"	BR	.625"	150	B	N/C	PD	24	474P-24	\$149.04
8.708-823.0	260467	S211-DG4	1/2"	BR	.625"	150	B	N/C	PD	110	474P-110	\$149.04
8.708-824.0	260468	S211-EG5	3/4"	BR	.750"	150	B	N/C	PD	24	476P-24	\$176.99
8.708-825.0	260469	S211-EG5	3/4"	BR	.750"	150	B	N/C	PD	110	476P-110	\$175.95
8.708-826.0	260470	S211-FG9	1"	BR	1.00"	150	B	N/C	PD	24	—	\$276.35
8.708-827.0	260471	S211-FG9	1"	BR	1.00"	150	B	N/C	PD	110	—	\$261.62
8.708-828.0	260479	S301-AD5	1/8"	BR	.101"	125	B	N/C	DA	110	491P-110	\$87.20
8.708-829.0	260480	S301-BD7	1/4"	BR	.109"	150	B	N/C	DA	24	401P-24	\$102.10
8.708-830.0	260481	S301-BD7	1/4"	BR	.109"	150	B	N/C	DA	110	401P-110	\$111.78
8.708-814.0	260458	S202-CG4	3/8"	BR	.281"	150	B	N/O	PD	24	0412P-24	\$220.46
8.708-815.0	260459	S202-CG4	3/8"	BR	.281"	150	B	N/O	PD	110	0412P-110	\$210.11
8.708-816.0	260460	S202-DG4	1/2"	BR	.438"	150	B	N/O	PD	24	0A414P-24	\$181.13
8.708-817.0	260461	S202-DG4	1/2"	BR	.438"	150	B	N/O	PD	110	0A414P-110	\$205.97
8.708-818.0	260462	S202-EG5	3/4"	BR	.593"	150	B	N/O	PD	24	0A416P-24	\$416.07
8.708-819.0	260463	S202-EG5	3/4"	BR	.593"	150	B	N/O	PD	110	0A416P-110	\$254.61
8.708-831.0	260482	S301-BD7	1/4"	SS	.125"	150	V	N/C	DA	24	424-2-24	\$106.61
8.708-832.0	260483	S301-BD7	1/4"	SS	.125"	150	V	N/C	DA	110	424-2-110	\$107.64
8.708-833.0	260484	S401-Z	3/8"	SS	.350"	1200	V	N/C	PP	24	453P-24	\$187.34
8.708-834.0	260485	S401-Z	3/8"	SS	.350"	1200	V	N/C	PP	110	453P-110	\$183.20
8.708-835.0	260486	S401-Z	1/2"	SS	.500"	1200	V	N/C	PP	24	454P-24	\$206.61
8.708-836.0	260487	S401-Z	1/2"	SS	.500"	1200	V	N/C	PP	110	454P-110	\$229.77

Replacement/Repair Kits for Solenoids Valves – continued from page 139

Part #	Old No.	Description	List Price
8.708-837.0	260488	24V AC Coil	\$33.95
8.708-838.0	260489	110V AC Coil	\$58.89
8.700-214.0	074801	Repair Kit – S301–1/4" valves (Buna)	\$15.99
8.700-215.0	074802	Repair Kit – S201–3/8" and 1/2" valves (Buna)	\$33.59
8.700-216.0	074806	Repair Kit – S202–3/4" valves (Buna)	\$75.71

Part #	Old No.	Description	List Price
8.700-217.0	074807	Repair Kit – S301–1/4" valves (Viton)	\$18.06
8.700-218.0	074808	Repair Kit – S401–3/8" and 1/2" valves (Viton)	\$82.49
8.700-219.0	074809	Repair Kit – S211–3/8" and 1/2" valves (Buna)	\$44.92
8.700-220.0	074810	Repair Kit – S211–3/4" valves (Buna)	\$29.45
8.700-221.0	074812	Repair Kit – S211–1-1/4", 1-1/2" and 2" valves (Buna)	\$186.30

Kip Solenoids



- Reliable over years of use
- Millions of cycles life not unusual
- All with FPT ports
- N/O = Normally Opened
- N/C = Normally Closed
- N/A= Not Adjustable
- C/A = Chemical Adjustment

Part #	Old No.	FPT	Voltage	Orifice ID	List Price
Stainless-steel					
8.708-846.0**	260511	N/C 1/4"	24V AC	N/A .062	\$142.80
8.708-847.0**	260515	N/O 1/4"	24V AC	N/A .062	\$245.30
8.708-849.0	260520	N/C 1/8"	24V AC	N/A .062	\$75.92
8.708-851.0	260525	N/C 1/4"	24V AC	C/A	\$100.08
8.708-852.0*	260526	N/C 1/4"	24V AC	C/A	\$101.84
8.708-853.0	260530	N/C 1/8"	24V AC	C/A	\$279.45
8.708-855.0	260534	N/C 1/4"	120V AC	N/A .093	\$82.80
8.708-856.0	260535	N/C 1/4"	24V AC	N/A .093	\$84.30
8.708-857.0*	260536	N/C 1/4"	120V AC	N/A .093	\$217.35
8.708-858.0*	260537	N/C 1/4"	24V AC	N/A .093	\$87.82

Brass Solenoid Valves – Kip

8.708-863.0*	260546	N/C 1/8"	240V AC	N/A .062	\$70.12
8.708-864.0*	260547	N/C 1/8"	120V AC	N/A .062	\$68.83

Parts

8.708-859.0	260538	Coil Only 120V	Wire Leads	\$36.79
8.708-860.0	260539	Coil Only 24V	Wire Leads	\$58.58
8.708-862.0	260542	Coil Only 24V	Spade Term	\$73.38
8.708-861.0	260541	Repair Kit N/C 1/4"		\$43.26

*Conduit Body Style w/ wire leads

**Wire Leads

Solenoids w/ Built-In Strainer

For pressure lines and pressure systems only.

Brass Valves – Diaphragm Style



- Normally closed valve operation
- Proven design features for reliable performance on all applications
- Rated to 200°F fluid and 120°F ambient
- Operates in any position, but do NOT mount valve with coil under valve

Part #	Old No.	Dema No.	FPT	Orifice	PSI	Voltage	List Price
8.711-249.0	396115	442P	1/4"	.25	125	24V AC	\$75.14
8.711-250.0	396116	442P	1/4"	.25	125	110V AC	\$108.68
8.711-252.0	396119	443P	3/8"	.25	125	24 V AC	\$79.07
8.711-253.0	396120	443P	3/8"	.25	125	110V AC	\$74.36

Celcon Plastic Valves

Super for strong chemicals.



- Diaphragm style with Y-screen (S.S.)
- Molded coil CSA-approved
- Compact design — 1/4" spade connects
- Normally closed operation
- 125 PSI
- 180°F
- 1/4" FPT, 1/4" orifice

Part #	Old No.	Dema No.	FPT	Orifice	PSI	Voltage	List Price
8.708-869.0	260560	P442	1/4"	.25	125	24V AC	\$56.51
8.708-870.0	260561	P442	1/4"	.25	125	110V AC	\$57.55
8.708-871.0	260562	P442	1/4"	.25	125	12V AC	\$62.41
8.708-872.0	260566	P443	3/8"	.25	125	24V AC	\$60.50
8.708-873.0	260567	P443	3/8"	.25	125	110V AC	\$58.22
8.708-874.0	260568	P443	3/8"	.25	125	12V DC	\$63.45

Erie Motortrol® Valve



- Three-way valve to switch hot and cold inlets to single outlet
- 1/2" MPT (all three)
- 24V AC

Part #	Old No.	Description	List Price
8.708-879.0	260580	Motortrol Valve	\$295.70

Aqua Master™ Model 440



Liquid level proportioning controls — automatically maintain drum level and chemical concentration. The Aqua Master automatically maintains a desired level of proportioned mixture in a drum, tank or other type reservoir.

Magnetically activated “snap acting” float valves provide full water flow to activate the chemical proportioners. There are two basic sizes to give a choice of water flows as shown in the table below. Chemical feed rate is adjusted by metering screw or threaded metering tips. The compact 440 float valve is made of Celcon® plastic and is easily accessible for field maintenance.

Liquid-level proportioning controls are available in two flow capacities, 4 and 22 GPM at 50 PSI. Either size can be used with or without a proportioner. The proportioner allows chemical to be inducted while the valve is open.

All models, except as noted, are equipped with siphon breakers to prevent backflow into the fresh water line. The proportioner discharge is provided with means for attaching a hose or piece of pipe for under water feeding to minimize sudsing.

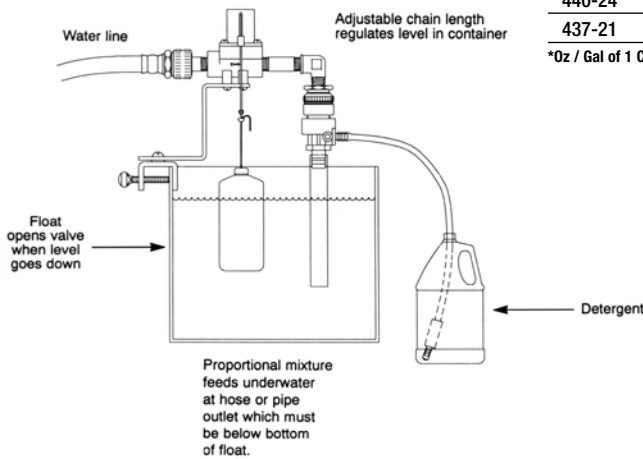

Model	Description	Capacity
440-23BT	Proportioning Valve, 4 GPM Flow at 50 PSI, Medium Capacity	12*
440-23T	Proportioning Valve, 4 GPM Flow at 50 PSI, High Capacity	35*
440-24	Proportioning Valve, 4 GPM Flow at 50 PSI, Highest Capacity	70*
437-21	Proportioning Valve, 22 GPM Flow at 50 PSI, Medium Capacity	10*

*Oz / Gal of 1 CPS Fluid (ie, Viscosity of Water)

Part #	Old No.	Description	List Price
8.710-525.0	360382	440-23BT	\$273.24
8.710-524.0	360381	440-23T	\$271.17
8.710-526.0	360383	440-24	\$327.06
8.710-532.0	360397	437-21	\$568.22
8.710-534.0	360399	Optional Tips	\$21.79

Proportioners

Designed to blend liquid chemical concentrates with water (flowing at normal city water pressure) to create an accurate mix of diluted chemicals. Complete with metering orifice set and/or metering adjustment valve.



Model	Description	Capacity
MAX BLEND RATE = Oz Chem Per Gal Water		
MODEL No.	1 CPS	75 CPS 220 CPS
162	24	14 6
163H*	64	30 14

*High-concentration chemical blender

1 CPS = Viscosity of Water
75 CPS = Viscosity of SAE 10 oil
220 CPS = Viscosity of SAE 30 oil

Part #	Old No.	Description	List Price
8.710-530.0	360393	#162 Drum Mount with Proportioner	\$153.18
8.710-529.0	360392	#163H High Concentrate Proportioner Low Side	\$76.07
8.700-226.0	074903	Polypropylene Foot Valve	\$7.35
8.710-534.0	360399	Optional Tips	\$21.79



Hypro Roller Pumps

Ideal for farm sprayers, pest control and chemical application usage.



- Housings available in cast-iron, Ni-resist or silver series
- Self-priming operation; roller pumps should not be run dry
- Adaptable to PTOs or gas engines
- Standard seals are Viton or Buna
- Standard super rollers provide the chemical resistance of nylon and long life of polypropylene
- Rotation is determined by looking at shaft end of pump
- Counter-clockwise is standard on all except 4001 and 4101 Series
- Maximum fluid temperature is 140°

Part #	Old No.	Model No.	Housing	Rotation	Shaft dia	No. of Rollers	Seals	List Price
8.702-278.0	100814	4001C	CI	CW	5/8"	4	V	\$266.00
8.702-281.0	100817	4101C	CI	CW	5/8"	4	V	\$253.58
8.702-259.0	100778	4101N	N	CW	5/8"	4	V	\$439.88
8.702-280.0	100815	4001XL	SL	CW	5/8"	4	V	\$641.70
8.702-261.0	100784	6500C	CI	CCW	5/8"	6	V	\$276.35
8.702-263.0	100784R	6500C-R	CI	CW	5/8"	6	V	\$280.49
8.702-262.0	100784N	6500N	N	CCW	5/8"	6	V	\$586.85
8.702-264.0	100784X	6500XL-R	SL	CW	5/8"	6	V	\$839.39
8.702-282.0	100819	7560C	CI	CCW	15/16"	8	V	\$346.73
8.702-283.0	100819R	7560C-R	CI	CW	15/16"	8	V	\$355.01
8.702-286.0	100823R	7560N-R	N	CW	15/16"	8	V	\$686.21
8.700-082.0	069665	Shaft Adapter (5/8" to 3/4")						\$21.94

NOTE: CI = Cast-Iron, N = Ni-Resist, SL = Silver Last

Performance Tables



Series 4001

- Max PSI 150
- Max GPM 9
- Max RPM 1,800

Pressure in PSI	GPM @1,100 RPM	HP	GPM @1,400 RPM	HP	GPM @1,800 RPM	HP
50	4.4	.24	5.9	.32	8.0	0.46
100	3.8	.41	5.3	.56	7.3	0.78
125	3.5	.50	5.0	.68	7.0	0.95
150	3.3	.62	4.8	.78	6.7	1.10

Series 6500

- Max PSI 300
- Max GPM 18.2
- Max RPM 1,000

Pressure in PSI	GPM @1,100 RPM	HP	GPM @1,400 RPM	HP	GPM @1,800 RPM	HP
50	8.0	0.38	16.5	0.71	20.1	0.90
100	7.2	0.68	15.4	1.26	19.1	1.51
200	5.6	1.29	14.0	2.34	17.3	2.84
300	4.3	1.91	12.7	3.47	15.7	4.17

Series 4101

- Max PSI 150
- Max GPM 7
- Max RPM 2,600

Pressure in PSI	GPM @1,100 RPM	HP	GPM @1,400 RPM	HP	GPM @1,800 RPM	HP
50	4.5	.34	5.60	.40	6.6	0.46
100	3.9	.56	5.00	.68	6.0	0.76
125	3.7	.68	0.82	.82	5.7	0.92
150	3.4	.78	4.40	.96	5.4	1.08v

Series 7560

- Max PSI 300
- Max GPM 22.5
- Max RPM 1,000

Pressure in PSI	GPM @1,100 RPM	HP	GPM @1,400 RPM	HP	GPM @1,800 RPM	HP
50	11.1	0.74	17.5	1.26	22.0	1.78
100	10.3	1.25	16.9	1.95	21.3	2.53
200	8.6	2.26	15.5	3.40	20.0	4.20
300	7.1	3.30	18.9	5.30	18.0	6.10

Twin-Diaphragm Spot Spray Pump



Specifications:

- 1 GPM (open)
- 35 PSI (#8 tip)
- 3/8" hose barb inlet/outlet
- Self-priming to 2.5 feet
- Operating temperature 40°-110°F
- Liquid temperature 110°F max
- 5 Amp fuse
- 1.3 lbs. dry weight

Features:

- Compact automatic on-demand operation
- Sealed pressure switch automatically stops pump when discharge valve opens and closes
- Self-priming so pump can be located above supply tank
- Can run dry for extended periods without damage
- Built-in thermal protection on 12V DC motor
- Low-Amp draw (2.5 @ 25 PSI, 4.0 @ 35 PSI)
- Chemical-resistant valves and diaphragm

Part #	Old No.	Description	Open Flow	Max PSI	Power	List Price
8.702-326.0	100880	Spot Spray Pump	1.0	35	12V DC	\$132.48

Flojet Diaphragm Pump

FLOJET

Built-in pressure switch automatically starts and stops pump instantaneously.



- Can run dry without damage
- Excellent self-priming capability
- Low-current draw

Part #	Old No.	Flojet Model No.	Power	Max Flow	Max PSI	Ports	Diaphragm*	Valves*	List Price
8.702-325.0	100879	2135-561	12V DC	1.48	60	3/8" FPT	B	V	\$261.86
8.702-328.0	100884	4300-142A	12V DC	3.30	40	1/2" Barb	S	E	\$293.94
8.702-312.0	100863	2100-032	115V	1.85	50	3/8" FPT	S	S	\$261.86
8.702-337.0	100895	2100-022A	115V	1.85	50	3/8" FPT	V	V	\$323.96
8.702-331.0	100888	4300-042	115V	3.70	35	1/2" Barb	S	E	\$363.29
8.702-329.0	100884A	4300-043A	115V	4.70	35	1/2" Barb	S	E	\$330.17

* B = BUNA V = Viton E = EPDM S = Santoprene

NOTE: These units are designed to withstand many harsh chemicals. However, because compounds and concentrations of materials pumped through these units are beyond the manufacturer's control, the manufacturer DOES NOT PROVIDE A WARRANTY on the wet-end of the pump.

Diaphragm Pump Units

SHURflo

1.00-3.8 GPM integrated pump motor units. Powered by 12V DC or 115V AC power. Pumps are standard with Santoprene® diaphragms and Viton valves for excellent service with a wide variety of sprayable products.

NOTE: Flow is reduced as pressure is increased (i.e. 100850 pumps 1.12 GPM @ 60 PSI) Automatic demand control on/off.



- Chemical-resistant materials
- Self-priming
- Automatic demand pressure switch or internal bypass
- Can run dry without damage
- Low-Amp draw

Part #	Old No.	Shurflo Model No.	Power	Max Flow	Max PSI	Ports	Diaphragm*	Valves*	List Price	
8.702-294.0	100841	8000-541-236	Demand	12V DC	1.0	60	3/8" FPT	S	V	\$178.02
8.702-304.0	100854	8000-343-236	Demand	12V DC	1.2	60	3/8" FPT	V	V	\$256.68
8.702-300.0	100850	8000-543-236	Demand	12V DC	1.4	60	3/8" FPT	S	V	\$178.02
8.702-296.0	100844	8000-543-238	Demand	12V DC	1.4	100	3/8" FPT	S	V	\$189.41
8.702-335.0	100893	8030-813-239	Demand	12V DC	1.5	150	3/8" FPT	S	V	\$300.15
8.702-302.0	100852	8002-793-238	Demand	12V DC	1.7	100	3/8" FPT	S	E	\$227.70
8.702-311.0	100862	8000-532-256	Demand	115V	1.0	60	3/8" FPT	S	V	\$258.75
8.702-307.0	100857	8000-033-236	Demand	115V	1.0	60	3/8" FPT	V	V	\$328.10
8.702-306.0	100856	8000-533-236	Demand	115V	1.4	60	3/8" FPT	S	V	\$275.01
8.702-334.0	100892	8000-812-288	Bypass	115V	1.4	100	3/8" FPT	S	V	\$301.19
8.702-308.0	100858	8000-813-238	Demand	115V	1.6	100	3/8" FPT	S	V	\$275.31
8.702-338.0	100896	8000-713-238	Demand	115V	1.6	100	3/8" FPT	S	E	\$276.35

2088 Premium Series – self-priming up to 12 foot – Built-in Back Check

8.702-305.0	100855	2088-343-135	Demand	12V DC	3.0	50	1/2"-14M	S	V	\$233.91
8.702-303.0	100853	2088-313-145	Demand	12V DC	3.6	50	1/2"-14M	S	V	\$409.86
8.702-301.0	100851	2088-712-244	Demand	12V DC	3.8	50	1/2"-14M	S	E	\$282.50
8.702-310.0	100861	2088-394-154	Demand	115V	3.2	40	1/2"-14M	S	V	\$314.64

4111 – Double Head

8.702-339.0	100899	4111-035	Demand	12V	7.0	50	1/2"-14M	S	V	\$575.46
--------------------	---------------	----------	--------	-----	-----	----	----------	---	---	----------

166 – Air Drive

8.702-317.0	100870	166-200-56	Demand	AIR	2.0	60	3/8" Barb	E	E	\$219.42
8.702-318.0	100871	166-200-36	Demand	AIR	2.0	60	3/8" Barb	V	V	\$282.56

*S = Santoprene V = Viton E = EPDM

NOTE: These units are designed to withstand many harsh chemicals. However, because compounds and concentrations of materials pumped through these units are beyond the manufacturer's control, the manufacturer DOES NOT PROVIDE A WARRANTY on the wet-end of the pump.

Aquatec 550 Series Diaphragm Pump

These pumps can either be controlled by a pressure switch ("demand" mode) or an external power control device. When required, an integrated bypass can be incorporated to help regulate pressure levels.



- Powerful flow rates up to 5.5 GPM/21 LPM at pressures up to 80 PSI/5.5 Bar
- Patented 5-chamber diaphragm and piston design
- Quiet noise levels and with minimal pulsations

Part #	Aquatec Model No.	Power	Max Flow	Max PSI	Ports	Diaphragm*	Valves*	List Price
8.750-812.0	25513-1E11-M638	12V DC	5.3	60	1/2" NPT	S	E	\$411.00

Industrial Chemical Sprayer

Excellent pre-prep chemical applicator. Trigger control, demand flow, wall-mount cabinet, enclosed pump unit pulls chemical from a bulk tank and delivers it through 100' lightweight hose for low-pressure stream/ cone or mist application. Operator simply squeezes trigger for instant application.



- Diaphragm pump units
- 60 PSI pressure
- Choice of 12V DC or 110V DC
- 100-foot hose
- Adjustable nozzle for cone mist to straight stream
- Durable Santoprene and Viton-wetted parts

Part #	Old No.	Description	Motor	PSI	GPM	List Price
Wall Mount / Cabinet Sprayer						
8.906-090.0	810020	Chem Applicator	115V AC	60	1.15	\$655.08
8.906-089.0	810010	Chem Applicator	12V DC	60	1.02	\$500.94

NOTE: These Units are designed to withstand many harsh chemicals. However, because compounds and concentrations of materials pumped through these units are beyond the manufacturer's control, the manufacturer DOES NOT PROVIDE A WARRANTY on the wet-end of the pump.

910 Spot Spray Gun Assembly

High-pressure trigger gun adapted to spot spray application.



- Durable and comfortable
- 12" plated steel lance
- 1/4" hose barb inlet
- #2 blue adjustable nozzle

Part #	Old No.	Description	List Price
8.904-088.0	352940	910 Spot Spray Gun Assembly	\$49.68

Spraymax Trigger Gun

For pest control applications.



- 1000 PSI
- 200° temperature
- Compare to JD-9, Mag-1, Robco and Ges
- Adjusts from fine mist to straight stream
- Drip-free shutoff
- Crafted for all-day comfortable use
- Larger trigger for 4-fingered grip

Part #	Old No.	Description	List Price
8.708-995.0	266693	With 1/2" Inlet	\$133.52
8.902-783.0	266693X	With 3/4" Garden Hose Inlet	\$135.59
8.709-028.0	268047	Repair Kit	\$23.96

Trigger-Control Spray Lances

Excellent for low-pressure chemical applications up to 150 PSI. Available in either plastic- or brass-lance tube. Works well with neutral, alkaline or mild acid solutions.



- Steel trigger and service wrench
- Plastic valve body
- Brass-needle plunger
- Filter screen in nozzle housing
- Standard 11/16" outlet thread for standard low-pressure nozzle
- Cone nozzle adjusts 0-80°
- Accepts the adjustable cone nozzles or standard tip-jet nozzles (11/16 nozzle thread)
- 24" lance — brass or plastic

Part #	Old No.	Description	List Price
Trigger Lance			
8.902-777.0	266606	Brass w/o Nozzle	\$48.54
8.902-778.0	266607	Plastic w/o Nozzle	\$51.49
8.708-977.0	266603	Plastic w/ Red Nozzle	\$48.88
8.708-978.0	266610	Brass w/ Red Nozzle	\$54.98
8.700-493.0	076700	Needle Valve and Seal Kit	\$6.93

Part #	Old No.	Description	80° Straight	Cone	List Price
Adjustable Nozzle – GPM @ 40 PSI / Adjust 0-80°					
8.708-979.0	266611	#1 Yellow	.316	.156	\$7.71
8.708-980.0	266612	#2 Red	.545	.204	\$8.02
8.708-981.0	266613	#3 Blue	.720	.250	\$8.45

Trigger Valves

Versatile hand-held trigger valves for chemical or water-flow control.



- 1/2" FPT inlet/outlet
- Lock-on trigger loop
- 18.5 GPM
- 700 PSI

Part #	Old No.	Description	List Price
Aluminum Body – SS/ BR Valve			
8.708-982.0	266652	Trigger Valve – Viton	\$53.51
Plastic body – SS/ BR Valve			
8.708-983.0	266658	Trigger Valve – Viton	\$41.46
8.708-984.0	266659	Trigger Valve – Buna	\$29.65

Trigger-Jet Spray Lances

Low-pressure chemical application lance will tolerate mild acid solutions.



- Diaphragm shut-off valve
- Hand-grip trigger control
- Plastic lance tube resistant to acids and agricultural chemicals
- 150 PSI
- Excellent for mild acids or alkali chemicals
- Polypropylene body EPDM seals STD
- 11/16" — nozzle connect outlet

Part #	Old No.	Description	List Price
Trigger Lance			
8.709-182.0	302250V	24" 1/4" FPT inlet, Viton	\$53.92
8.709-183.0	302251	24" 1/4" HB inlet, EPDM	\$53.92
8.709-184.0	302252V	3/8" Hose Barb, Viton	\$53.87

Trigger Value Only			
8.709-185.0	302254V	3/8" HB Inlet/ 11/16" Outlet, Viton	\$36.23
8.709-186.0	302255V	1/4" HB Inlet/ 11/16" Outlet, Viton	\$35.03
8.709-187.0	302256V	1/4" FPT Inlet/ 11/16" Outlet, Viton	\$33.59

Parts and Accessories – Trigger Jet Lance			
8.709-188.0	302258	Adapter, 11/16" x 11/16" PP	\$2.12
8.709-189.0	302259	24" Lance Tube only	\$22.82
8.709-190.0	302260	24" Lance Tube w/ Seals and Fittings	\$23.49

Trigger Jet Nozzles – Polypropylene adjust from 0° to 60° Cone			
8.709-192.0	302263	Yellow Core(x 3), .23 GPM/ 60 PSI	\$10.76
8.709-193.0	302265	Green Core (x 5), .37 GPM/ 60 PSI	\$10.76
8.709-194.0	302266	Red Core (x 6), .45 GPM/ 60 PSI	\$10.76
8.709-195.0	302268	Gray Core (x 8), .57 GPM/ 60 PSI	\$10.76
8.709-196.0	302272	Brown Core (x 12), .84 GPM/ 60 PSI	\$10.76
8.709-197.0	302274	Orange Core (x 18), 1.2 GPM/ 60 PSI	\$10.76

Turbine Series Guns

Forged-brass housings, stainless-steel lances, mist cone to straight stream adjustment, on/off control, lock-on trigger, 1/2" MPT inlet Viton seals, up to 1200 PSI at 140°F.



- 1200 PSI
- 1/2" BSP male inlet
- Weighs only 4 lbs.
- Standard 15 x 1 LRT (4.5mm)
- 62 ft.-reach, straight stream @ 850 PSI
- 31.5 ft.-reach, full cone @ 850 PSI

Part #	Old No.	Description	Length	List Price
8.708-990.0	266680	Long Range Turbine	27-1/2"	\$275.31
8.708-989.0	266676	Turbine	26-1/2"	\$226.60

15 x 1 Long Range Tip – Stainless-Steel

Best used with long-range turbine gun.



- 15 x 1 long-range tip
- Stainless-steel body
- 850 PSI
- 24.4 GPM
- 77 ft. max throw range

List Price	Orifice		Orifice	
	Old No.	Part # Dia (mm)	Old No.	Part # Dia (mm)
\$23.60	8.708-998.0	266706 3.5	8.709-001.0	266709 5.0
	8.708-999.0	266707 4.0	8.709-002.0	266710 5.5
	8.709-000.0	266708 4.5	8.709-003.0	266711 6.0
			8.709-004.0	266712 7.0

Low-Flow Brass Pressure Regulator



- For sprayers pumping up to 5 GPM
- Durable and strong brass construction
- Stainless-steel spring
- Positive Viton seal to prevent leakage
- Knurled locknut for easy adjustment
- 1/2" MPT inlet
- 1/2" FPT outlet
- 120°F temperature
- 10.3 oz weight

Part #	Old No.	Description	List Price
8.712-553.0	462207	200-650 PSI	\$60.86
8.712-554.0	462208	0-300 PSI	\$53.56

Brass Pressure Regulator

Durable and strong.



- For sprayers pumping up to 15 GPM
- Adjustable pressure ranges
- Stainless-steel spring
- Tee-handle adjustment screw
- 3/4" MPT inlet
- Knurled locknut for ease of locking in adjustment
- 3/4" FPT outlet
- 120°F temperature
- 10.3 oz weight

Part #	Old No.	Description	List Price
8.712-557.0	462217	0-300 PSI	\$59.15
8.712-558.0	462218	300-700 PSI	\$61.17

Heavy-Duty Swivels

Live swivels help prevent twisted and tangled hose.



8.708-996.0

- Brass body and stainless-steel bolt
- Viton seals
- 600 PSI
- 1/2" MPT inlet and 1/2" outlet

Part #	Old No.	Description	List Price
8.708-996.0	266700	Swivel 1/2" M x F	\$19.87
8.708-997.0	266701	Swivel 1/2" M x 3/4" FGH	\$26.96

Nylon Pressure Regulator

Maximum corrosion resistance.



- Built to handle up to 15 GPM
- Stainless-steel spring
- Positive Viton seal prevents leakage and provides the best chemical resistance
- Knurled locknut for ease of locking in adjustment
- Tee-handle adjustment screw
- Choice of 1/2" or 3/4" inlet/outlet
- Male inlet/female outlet
- 120°F temperature
- 4 oz weight

Part #	Old No.	Inlet	Outlet	Adjustable Pressure Range	List Price
8.712-555.0	462212	1/2"	3/4"	0-250 PSI	\$29.55
8.712-552.0	462202	3/4"	3/4"	0-250 PSI	\$29.91
8.712-556.0	462213	3/4"	3/4"	0-400 PSI	\$30.27

Bulkhead Fittings



- Black polypropylene
- Double-threaded with EPDM gasket
- Opening same size as outside diameter

Part #	Old No.	FPT	Hole Dia	List Price
8.705-336.0	141232	1/2"	1-5/8"	\$16.61
8.705-338.0	141234	3/4"	1-5/8"	\$16.46
8.705-144.0	140430	3/4"	1-3/4"	\$7.45
8.705-145.0	140432	1"	1-3/4"	\$7.56
8.705-339.0	141236	1"	2-1/2"	\$22.82
8.705-341.0	141238	1-1/4"	2-1/2"	\$24.12
8.705-342.0	141240	1-1/2"	2-1/2"	\$23.03
8.705-146.0	140434	1-1/2"	3"	\$14.65
8.705-147.0	140436	2"	3"	\$12.58
8.705-343.0	141242	2"	3-1/8"	\$29.24

Gaskets for Above

8.705-337.0	141233	Fits 1/2", 3/4"	\$3.47
8.705-340.0	141237	Fits 1", 1-1/4", 1-1/2"	\$8.23
8.705-344.0	141243	Fits 2"	\$5.02

Brass Bulkhead / Tank Fittings



- Use to drain or remove liquids from tanks, drums, etc.
- Heavy-duty brass
- Includes nut and aluminum grip washer

Part #	Old No.	Overall Length	Mounting Hole Dia	List Price
8.705-139.0	140417	1/8" x 1.5"	5/8"	\$6.57
8.705-140.0	140419	1/4" x .94"	3/4"	\$10.35
8.705-141.0	140420	1/4" x 1.5"	3/4"	\$8.59
9.802-149.0	140421	3/8" x 1.3"	1"	\$9.94
9.802-150.0	140422	1/2" x 1.5"	1-1/8"	\$12.73

NOTE: Installation requires access to inside of tank.

Diaphragm Check Valves – Nylon

For drip-free spraying.



- 125 PSI
- 2 GPM
- Nylon body, polypropylene end cap – EPDM – diaphragm
- 10 PSI opening pressure
- 1/4" MPT inlet, 11/16" — 16 male outlet nozzle thread
- Spring-backed diaphragm for positive action

Part #	Old No.	Description	List Price
8.709-377.0	310851	Diaphragm Check Valves	\$20.08

DO NOT USE ... Polypropylene for: gasoline, nitric acid, trichlorethylene, toluene, aromatic hydrocarbons or kerosene. Polypropylene "P" — black/glass reinforced.

DO NOT USE ... Nylon for: hydrochloric acid, chlorine, fluorine, nitric, xylene or phosphoric or sulfuric acids. Nylon 6/6 "N" white/natural color.

Plastic Fittings

For cater and chemical supply lines. Ideal for use with most alkaline-based detergents, most agricultural chemicals, ethanol, and most ammonium and sodium-based compounds.

- 150 PSI
- 140°F max @ 90 PSI
- 90°F max @ 150 PSI

Part #	Old No.	Description	Barb x MPT	List Price
--------	---------	-------------	------------	------------

Hose Barbs – Barb x MPT

8.705-262.0	141077P	Poly	1/4" x 1/4"	\$0.69
8.705-264.0	141080P	Poly	1/4" x 3/8"	\$0.73
8.705-263.0	141078P	Poly	3/8" x 1/4"	\$0.73
8.705-265.0	141081P	Poly	3/8" x 3/8"	\$0.70
8.705-268.0	141084P	Poly	1/2" x 3/8"	\$0.76
8.705-270.0	141086P	Poly	5/8" x 1/2"	\$0.70
8.705-277.0	141102N	Nylon	1/4" x 1/4"	\$0.69
8.705-280.0	141105N	Nylon	1/4" x 3/8"	\$0.73
8.705-278.0	141103N	Nylon	3/8" x 1/4"	\$0.73
8.705-281.0	141106N	Nylon	3/8" x 3/8"	\$0.70
8.705-284.0	141110N	Nylon	3/8" x 1/2"	\$0.73
8.705-282.0	141107N	Nylon	1/2" x 3/8"	\$0.76
8.705-285.0	141111N	Nylon	1/2" x 1/2"	\$0.82
8.705-288.0	141117N	Nylon	1/2" x 3/4"	\$0.84
8.705-283.0	141108N	Nylon	5/8" x 3/8"	\$0.84
8.705-286.0	141112N	Nylon	5/8" x 1/2"	\$0.69
8.705-289.0	141118N	Nylon	5/8" x 3/4"	\$0.70
8.705-287.0	141113N	Nylon	3/4" x 1/2"	\$0.64
8.705-290.0	141119N	Nylon	3/4" x 3/4"	\$0.98
8.705-291.0	141120N	Nylon	1" x 3/4"	\$1.29

90° Barb x MPT Elbows

8.705-293.0	141125P	Poly	1/4" x 1/4"	\$1.40
8.705-296.0	141130P	Poly	1/4" x 3/8"	\$1.45
8.705-294.0	141126P	Poly	3/8" x 1/4"	\$1.60
8.705-298.0	141131P	Poly	3/8" x 3/8"	\$1.60
8.705-301.0	141136P	Poly	3/8" x 1/2"	\$1.66
8.705-295.0	141127P	Poly	1/2" x 1/4"	\$1.55
8.705-299.0	141132P	Poly	1/2" x 3/8"	\$1.66
8.705-303.0	141137P	Poly	1/2" x 1/2"	\$1.55
8.705-307.0	141141P	Poly	1/2" x 3/4"	\$1.81
8.705-304.0	141138P	Poly	5/8" x 1/2"	\$1.09
8.705-308.0	141142P	Poly	5/8" x 3/4"	\$1.76
8.705-305.0	141139P	Poly	3/4" x 1/2"	\$1.76
8.705-310.0	141143P	Poly	3/4" x 3/4"	\$1.76
8.705-297.0	141131N	Nylon	3/8" x 3/8"	\$1.60
8.705-300.0	141136N	Nylon	3/8" x 1/2"	\$1.66
8.705-302.0	141137N	Nylon	1/2" x 1/2"	\$1.55
8.705-306.0	141141N	Nylon	1/2" x 3/4"	\$1.81
8.705-309.0	141143N	Nylon	3/4" x 3/4"	\$1.76

HEX Nipple – MPT x MPT

8.705-316.0	141184P	Poly	1/4" x 1/4"	\$0.76
8.705-317.0	141185P	Poly	3/8" x 3/8"	\$0.89
8.705-323.0	141190P	Poly	1/2" x 3/8"	\$0.82
8.705-319.0	141186P	Poly	1/2" x 1/2"	\$0.60
8.705-326.0	141193P	Poly	3/4" x 1/2"	\$0.77
8.705-321.0	141187P	Poly	3/4" x 3/4"	\$1.01
8.705-324.0	141191N	Nylon	1/2" x 1/4"	\$0.68
8.705-322.0	141190N	Nylon	1/2" x 3/8"	\$0.91
8.705-318.0	141186N	Nylon	1/2" x 1/2"	\$0.59
8.705-320.0	141187N	Nylon	3/4" x 3/4"	\$1.00

Elbows – Barb x Barb

8.705-335.0	141216P	Poly	3/8" x 3/8"	\$0.88
-------------	---------	------	-------------	--------

Tees Barb x Barb x Barb

8.705-329.0	141207P	Poly	1/2" BxBxB	\$1.00
8.705-332.0	141215P	Poly	3/4" BxBxB	\$1.35
8.705-327.0	141202N	Nylon	1/4" BxBxB	\$0.81
8.705-328.0	141205N	Nylon	3/8" BxBxB	\$1.01
8.705-334.0	141216N	Nylon	3/4" BxBxB	\$1.14

"Push-On" Hose Barbs – (Normally does not require clamps)

8.705-346.0	141305N	Nylon	1/4" Bx1/4" FPT	\$2.43
-------------	---------	-------	-----------------	--------

Sprayers and Parts

Professional Stainless-Steel Sprayer



- Stainless-steel tank
- Brass wand
- Brass cap
- Brass handle
- Precise spray patterns (both straight stream and fan spray) from an all-brass tip
- Famous non-drip nozzle that professionals demand

Part #	Description	List Price
8.697-373.0	Pro Stainless-Steel Sprayer	\$222.75

Stainless-Steel Industrial Sprayer

2-gallon industrial sprayer. Plastic valve and brass extensions, fan-spray tip.



- Heavy-duty stainless-steel tank
- Plastic valve with brass extension
- Chemical-resistant seals
- Available in 2- and 3-gallon capacities
- Plastic pin-to-cone spray tip
- Funnel top design

Part #	Description	List Price
8.697-170.0	Stainless-Steel Industrial Sprayer	\$131.64

Stainless-Steel Sprayer

2-gallon sprayer with plastic valve and extension. Adjustable pin-to-cone tip.



- Heavy-duty stainless-steel tank
- Chemical-resistant hose
- Plastic valve and extension
- Buna-N seals and gaskets
- Pin-to-cone adjustable spray tip
- 2-gallon capacity
- Economically priced but durable

Part #	Description	List Price
8.697-169.0	Stainless-Steel Sprayer	\$100.76

Sprayer – Chemical-Resistant

Large funnel top, poly-molded, chemical-resistant.



- Heavy-duty polyethylene tank
- Wide base for extra stability
- Durable brass valve and extension
- Chemical-resistant seals
- Reinforced chemical-resistant hose
- Celcon fan spray tip
- Brass spray gun

Part #	Description	List Price
8.697-165.0	Sprayer Chemical Resistant – 1 gallon	\$72.81
8.697-168.0	Sprayer Chemical Resistant – 2 gallon	\$75.35
8.697-171.0	Sprayer Chemical Resistant – 3 gallon	\$95.12

Poly-Molded Sprayer

3-gallon poly-molded sprayer with maximum chemical resistance.



- Heavy-duty design, economical price
- Blue poly-molded tank
- Funnel top design for ease-of-filling
- Durable plastic valve and extension
- Pin-to-cone spray tip
- Fully repairable
- Braided, reinforced hose
- Optional flat-fan spray tips available
- Buna-N gaskets and seals

Part #	Description	List Price
8.697-172.0	Poly-Molded Sprayer	\$42.49

Foam Nozzle Attachment

Foaming nozzle attachment fits: Stainless and hand-held sprayers.



Part #	Description	List Price
8.697-164.0	Foam Nozzle Attachment	\$11.49

Sprayermaster Adjustable

7-quart adjustable Spraymaster.



- Direct-dial adjustable valve
- Swivel quick disconnects
- T-jet/check valve

Part #	Description	List Price
8.697-411.0	Sprayermaster Adjustable	\$626.73

Sprayermaster – High-Pressure

5-quart high-pressure Spraymaster.



- 4-1 or 9-1 dilution ratio

Part #	Description	List Price
8.697-413.0	Sprayermaster High-Pressure	\$263.25

Sprayermaster – Standard

7-quart standard Spraymaster.



- 9-1 complete
- Includes swivel quick disconnects
- T-jet / check valve

Part #	Description	List Price
8.697-412.0	Spraymaster Standard	\$200.79

Trigger Sprayer – Ergonomic



Ergonomic trigger sprayer.

- Proven reliability
- Unmatched quality
- Excellent aesthetics
- Superior functional features

Part #	Description	List Price
8.697-180.0	Trigger Sprayer / Ergonomic	\$2.54

Trigger Sprayer – Chemical-Resistant

Chemical-resistant trigger sprayer.



- 9 - 7 1/4 8" tube length
- 28mm / 400 thread finish
- Made of chemical-resistant polymers

Part #	Description	List Price
8.697-179.0	Trigger Sprayer / Chemical Resistant	\$3.12

Trigger Sprayer – Ultra-Spray

Ultra-spray trigger sprayer.



- 9 - 7 1/4 8" tube length
- 28mm / 400 thread finish
- Made of PTMT; a chemical-resistant plastic

Part #	Description	List Price
8.697-177.0	Trigger Sprayer / Ultra Spray	\$3.31

Equipment

Rotovac WideTrack

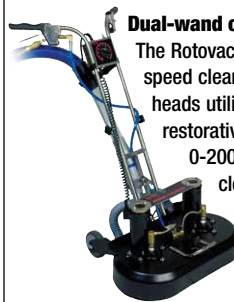

Dual-wand cleaning speed with one-man operation.

The Rotovac WideTrack is a 24"-wide rotary-extraction tool for high-speed cleaning of large areas. Dual rotary-jet extraction cleaning heads utilize six vacuum slots / six spray jets to produce thorough, restorative cleaning. The cleaning heads spin at an adjustable 0-200 rpm. The WideTrack operates like a lawn mower and cleans equally in both directions up and back. Designed for use with any truck mount or dual 3-stage vacuum portable, the WideTrack delivers all the power of your extractor while requiring only one man to operate it. The ergonomic, dual-handle design in combination with the high torque drive motors make the

WideTrack extremely easy to push as it power cleans through heavily-soiled areas with ease. The high-speed cleaning power of the WideTrack can cut labor costs by up to 50%.

Part #	Description	List Price
8.697-361.0	Rotovac WideTrack	\$7,957.08

Tile and Hard Surface Tools

Hand-Spinner Tool

Standard hand-spinner tool.



- Double-bearing and ceramic-seal assembly for high-pressure cleaning
- All stainless-steel construction
- 1.5" vacuum hose, angled nozzles, brush attachment and splashguard to ensure a clean, professional job

Part #	Description	List Price
8.697-374.0	Hand-Spinner Tool	\$1,239.93

Hand-Spinner Tool with 10' Hose

Standard hand-spinner tool with 10" hose attachment.



- 10" hose attachment
- Double-bearing and ceramic-seal assembly for high-pressure cleaning
- All stainless-steel construction
- 1.5" vacuum hose, angled nozzles, brush attachment and splashguard to ensure a clean, professional job

Part #	Description	List Price
8.697-375.0	Hand-Spinner Tool w/ 10' Hose	\$474.95

Hard-Surface Spinner Tool

Professional-grade, hard-surface spinner tool.



- All stainless-steel construction
- Vacuum hose inlet fits either 1.5" or 2" hose
- Angled nozzles, splashguard, high-pressure double-bearing and ceramic-seal assembly ensures professional results.

Part #	Description	List Price
8.697-376.0	Hard-Surface Spinner Tool	\$1,231.65

Van Accessories

Stainless-Steel Shelving

Van shelving.



Part #	Description	List Price
8.697-002.0	Stainless-Steel Shelving	\$446.04

Solution Hose Live Swivel Assembly



Turns your solution reel live for direct hookup.

- High-pressure
- 1/4" hose

Part #	Description	List Price
8.697-344.0	Solution Hose Live Swivel Assbly	\$349.83

Restoration Equipment and Accessories

UV Flashlight 32 LED Blaze

32 individual LED UV flashlight.

The Blaze-3285 flashlight offers an impressive 32 individual UV 380-385 nM LEDs. It is small and lightweight. The perfect flashlight for doing inspections in dark areas where more UV output is not needed. This flashlight is favored in janitorial and tile cleaning inspections.



- Bulb type: Longwave UV LED, 380-385 nM
- Bulb life: 100,000 hours
- Body material: Aluminum with "O" rings for water resistance
- Battery required: 3 x AAA alkaline battery (not included)
- Battery life: Approximately 25 hours on three AAA batteries
- Switch type: Push on/off button off the neck
- Weight: 6 oz
- Head diameter: 1.75" or 45mm
- Body diameter: 1.2" or 30.5 mm
- Length: 5.6" or 142 mm

Part #	Description	List Price
8.697-326.0	UV Flashlight 32 LED Blaze	\$162.10

UV Flashlight 51 LED Blaze

51 individual LED UV flashlight.

Blaze-5185 flashlight offers an amazing 51 individual 385 nM UV LEDs which makes it one of the largest LED flashlights on the market. Unlike the higher wave length 400 nM versions that come with a strong visible purple light and a hefty price tag, this one puts out less visible light making inspections more accurate and easier. All of this packed in a lightweight, brushed-aluminum body weighing just 10 ounces.



- Bulb type: Longwave UV LED, 380-385 nM
- Bulb life: 100,000 hours
- Body material: Aluminum with "O" rings for water resistance
- Battery required: 3 x AA alkaline battery (not included)
- Battery life: Approximately 20 hours on three AA batteries
- Switch type: Push on/off button
- Weight: 8 oz
- Head diameter: 2.15" or 55 mm
- Body diameter: 1.38" or 35 mm
- Length: 5.5" or 140 mm

Part #	Description	List Price
8.697-328.0	UV Flashlight 51 LED Blaze	\$191.01

UV Flashlight Blaze 128 LED

128 Individual LED UV Flashlight.

The Blaze-XL128 flashlight offers an amazing 128 individual LEDs which makes it the largest LED flashlight on the market. Unlike the higher wave length 400 nM versions that come with a strong visible purple light and a hefty price tag, this one puts out less visible light making inspections more accurate and easier. All of this packed in a lightweight aluminum body weighing just 22 ounces.



- Bulb type: 390 to 395 (nM)
- Bulb life: 100,000 hours
- Body material: Aluminum with "O" rings for water resistance
- Battery require: 3 x D size alkaline battery (not included)
- Battery life: Approximately 40 hours on three D-size batteries
- Switch type: Click on/Click off
- Weight: 1.5 LB (without batteries)
- Head diameter: 3.375" or 55 mm
- Body diameter: 1.5" or 38 mm
- Length: 12" or 254 mm

Part #	Description	List Price
8.697-331.0	UV Flashlight 128 LED Blaze	\$441.91

Data Log Temperature and Humidity Kit

Humidity and temperature USB datalogger.



- 32,000 readings (16,000 for each parameter: humidity/temperature)
- Dew point indication via Windows® software (included)
- Selectable data sampling rate: 2s, 5s, 10s, 30s, 1m, 10m, 30m, 1hr, 2hr, 3hr, 6hr, 12hr, 24hr
- User-programmable alarm thresholds for RH and Temperature
- Status indication via Red / Yellow LED and Green LED
- Long battery life
- Dimensions: 5.1 x 1.1 x 0.9" (130 x 30 x 25mm) / weight: 1oz (20g)
- Complete with 3.6V Lithium battery and Windows-compatible analysis software

Part #	Description	List Price
8.697-355.0	Data Log Temperature and Humidity Kit	\$268.07

Humidity Temperature Pen

Compact, digital hygro-thermometer, ideal for field use.



- Simultaneous display of temperature (°C/°F) and relative humidity
- Max/Min and Data Hold
- Built-in self calibration utility allows for field calibrations using optional relative humidity calibration bottles
- Includes meter with pocket clip and 3V Lithium battery

Part #	Description	List Price
8.697-353.0	Humidity Temperature Pen	\$134.10

Hygro and InfraRed Thermometer

Humidity, air temperature plus IR for non-contact temperature measurements.



- Combination humidity meter plus infrared thermometer features a super large backlit dual display.
- Primary and secondary displays: Primary display is user-selectable for IR or humidity; secondary always displays ambient temperature.
- Infrared thermometer has built-in laser pointer and an 8:1 distance-to-target ratio.
- Auto power-off
- Data Hold and MAX

Part #	Description	List Price
8.697-398.0	Hygro and InfraRed Thermometer	\$535.10

IR Laser Thermometer

6:1 compact infrared thermometer with laser pointer.



- Temperature range: -4 to 500°F (-20 to 260°C)
- Built-in laser pointer for easy targeting
- Large backlit LCD display
- Fixed 0.95 emissivity covers 90% of surface applications
- Automatic data hold when trigger released
- Auto power-off

Part #	Description	List Price
8.697-354.0	IR Laser Thermometer	\$234.38

Mini Thermo-Anemometer

Mini Thermo-Anemometer + Humidity.



- Fold-up protective housing extends to 9" for better reach
- Large dual-display of air velocity and temperature
- Data Hold to freeze most recent display
- Auto shut-off 20 minutes after last key is pressed
- Water-resistant housing floats
- Drop-tested to 6 feet

Wind Speed

- Measures ft/min, MPH, m/s, km/h, Knots and Beaufort Force
- Selectable averaging function of 5, 10, or 13 second intervals
- Replaceable non-corrosive plastic wind vane (impeller)

Temperature and Wind Chill

- Measures from 0 to 122°F (-18 to 50°C).

Relative Humidity and Dew Point

- Dual-display of air velocity and relative humidity
- Measures RH from 10% to 95%
- Measure Dew Point from 32°F to 122°F

Part #	Description	List Price
8.697-356.0	Mini Thermo-Anemometer	\$334.31

Precision Psychrometer

Highest 2% RH accuracy with fast 30-second response time.



- Fast response time (30 seconds)
- Dual backlit display
- Simultaneous display of: Humidity/Temperature, Humidity/Dew Point or Humidity/Wet Bulb
- Data Hold and Min/Max functions

Part #	Description	List Price
8.697-357.0	Precision Psychrometer	\$602.37

Waterproof ExStik pH Meter



- 1-, 2- or 3-point calibration automatically recognizes buffer solutions
- Automatic temperature compensation simultaneous display of pH and temperature
- Display indicates when the reading is stabilized
- Data Hold, Auto Power-Off and low-battery indication
- Waterproof design floats in water and protects the meter in wet environment
- Interchangeable probes available for Chlorine and ORP
- Optional weighted base holds plastic cup and ExStik® meter

Part #	Description	List Price
8.697-330.0	Waterproof ExStik pH meter	\$239.09

Extech pH Meter Buffer Solution

Calibrating buffer solution.



Part #	Description	List Price
8.697-395.0	Buffer Solution – pH 10	\$77.11
8.697-397.0	Buffer Solution – pH 7	\$34.31
8.697-396.0	Buffer Solution – pH 4	\$77.11

Sonin 4-in-1 Multifunction Detector

4-1-1 stud, moisture, metal, and voltage detector.



- Detects moisture percentages 8%-22%
- Helps find if potentially damaging excess moisture is present
- Locate and trace water leaks to prevent wet rot
- Detects wood and metal studs, beams and joists behind walls up to 3/4" deep
- Non-contact voltage detection helps you trace and locate live AC wire behind walls, ceilings, up to 2" deep
- Detects nails in wood up to 2" deep
- Detect and locate hidden metal, steel and copper pipes, and frames (both ferrous and nonferrous) behind walls up to 2" deep
- Fast, accurate and easy-to-read LED display with audible indicator
- Microprocessor-based instrument with automatic calibration to ensure accuracy
- Low-battery warning
- Requires one 9V battery (not included)
- One-year warranty

Part #	Description	List Price
8.697-029.0	Sonin 4-in-1 Multifunction Detector	\$125.24

Sonin Laser Targeting Range Finder

Take the guesswork out of ultrasonic-distance measuring by pinpointing the approximate center of your target area.



- Adds linear measurements, area, volumes
- Measures in Ft/In, M/Cm, Decimal Ft. and Yds.
- Tracking and validate modes
- Can measure from top or bottom of unit
- Seven memories with easy recall
- Automatic internal temperature compensation
- Auto shut-off seven minutes after last use
- Multi-lingual detailed instruction booklet
- Low-battery warning
- Requires one 9V battery (not included)
- Accuracy 99.5% +/- 1/4" (1cm)
- Protective pouch with belt loop
- Recommended for indoor-use only
- One-year warranty

Part No.	Description	List Price
8.697-036.0	Sonin Laser Targeting Range Finder	\$97.55

Sonin Water Alarm with Remote Sensor

Sonin Water Alarm warns of leaks and overflows in bath, kitchen, laundry, furnace, computer rooms or anywhere there is a potential for leaks.



- Low-battery signal tells user when it's time to replace the battery
- Circuit test bar ensures system is working
- Alerts user within hearing range that water has reached desired level when used to monitor the filling of pools, tubs, sinks, aquariums and more
- An ideal backup system for sump and bilge pumps in residential, commercial and marine applications
- Sensor and alarm can be placed up to 6 feet apart
- Loud 85 dB (decibel buzzer). Sounds for up to three days

Part #	Description	List Price
8.697-000.0	Sonin Water Alarm w/ Remote Sensor	\$37.52

Sonin Digital Moisture Meter



- Measures moisture levels from 5 to 40%, resolution 1%
- Easy-to-read, large LCD display with low-battery symbol
- Date-hold function
- Replacement probe included
- Protective carrying pouch included

Part No.	Description	List Price
8.750-460.0	Sonin Digital Moisture Meter	\$132.48

Sonin Moisture Test Meter

Dual-reading scale gives relative (1-10) and moisture percentages 10-28% readings.



- Contact probes are on a 3'-coiled cable for detecting moisture in hard to reach spots
- The 10-point scale corresponds to moisture levels from 10-28%
- Scale and reference chart correlate relative and moisture percentage readings
- Great for inspectors, contractors and homeowners
- Test hard or soft wood, concrete, plaster, carpet and more to determine the extent of moisture problems
- Find out if potentially damaging excess moisture is present
- Locate and trace roof leaks and water seepage; assess the extent of wet rot and hidden condensation
- Use it to check surfaces before painting, wallpapering or laying floors or tile
- Helps you to select drier lumber
- Requires one 9V battery (not included)
- Instruction sheet included
- One-year warranty

Part #	Description	List Price
8.697-031.0	Sonin Moisture Test Meter	\$125.24

Sonin Multi-Measure 45

Easy-to-use tapeless distance-measuring tool. Get the entire square footage of a house in only minutes.



- Measures from 1'10" up to 45 feet (13 meters)
- Displays measurements to the 1/4"
- Computes areas and volumes
- Adds linear measurements, area, volumes
- Measures in Ft/In, M/Cm
- Tracking and Validate modes
- Automatic internal temperature compensation
- Auto shut-off seven minutes after last use
- Multi-lingual detailed instruction booklet
- Multi-lingual quick-reference instruction label
- Low-battery warning
- Requires one 9V battery (not included)
- Accuracy 99.5% +/- 1/4" (1cm)
- Recommended for indoor-use only
- One-year warranty

Part No.	Description	List Price
8.697-037.0	Sonin Multi-Measure 45	\$75.09

Ozone Generator Villa 1000

Eliminate odors naturally.

The odor-free purifier will oxidize unwanted odors in your facility. It generates O3, or ozone, which disbursts into the space to be treated. The O3 attacks odors at their source and sanitizes the entire treatment area. It is especially effective on:



- Cigarette smoke
- Mold and mildew
- Smoke damage
- Food odors
- Pet odors
- Carpet odors
- Water damage
- Cleaning fumes
- Beverage odors
- Decaying matter
- New construction
- Microorganisms

Part #	Description	List Price
8.697-128.0	Ozone Generator Villa 1000	\$395.02

Moisture Sensor, Hydro Shark



- 31" long
- Reads moisture content of 17%
- For use in urine detection and moisture mapping

Part #	Description	List Price
8.697-417.0	Moisture Sensor, Hydro Shark	\$426.42

Pump Out Shield

The safer and healthier solution to waste water removal.



- Easy to install
- Protects client's walls and floors
- Reduces cleanup

Part #	Description	List Price
8.697-399.0	Pump Out Shield	\$278.78

Carbon, Vapor Lock Filter

Third-stage, vapor-lock carbon filter.



- Third-stage, 2" high-capacity, carbon, vapor-lock filter
- The third-stage filter has woven carbon media for absorption of gases and odors
- It is recommended you change the third-stage filter every six to 12 months under normal operating conditions

Part #	Description	List Price
8.697-390.0	Carbon, Vapor Lock Filter	\$879.75

Second-Stage Particulate Filter

2" second-stage, pleated particulate filter.



- Second-stage, pleated particulate filter
- Removes more finer particulates than the first-stage filter
- It is recommended you change the second-stage filter every six to nine months under normal operating conditions

Part #	Description	List Price
8.697-389.0	Carbon, Vapor Lock Filter	\$99.67

Fiber Trapper Pre-Filter

Particulate pre-filter for air filtration units used for commercial, industrial, residential, and healthcare applications.



The FiberTrap pre-filter is designed to capture the coarsest particles circulating through your air duct system which helps to extend the life of the second-stage carbon-pleated filter and the HEPA filter, saving you money!

Part #	Description	List Price
8.697-386.0	Fiber Trapper Pre-Filter	\$66.08

HEPA Filter PRED 1200

Final-stage, round High-Efficiency Particulate Arresting (HEPA) filter.



- Final-stage, round replacement HEPA filter
- HEPA filters capture 99.97% of airborne contaminants as small as 0.3 microns in size
- The H610C-99 removes bacteria, mold spores, soot, pollens, animal hair, animal dander, dust mites, smoke particles and other allergens and lung damaging particles
- It is recommended you change the final filter every two to three years under normal operating conditions

Part #	Description	List Price
8.697-383.0	HEPA Filter PRED 1200	\$684.14

Predator 1200 Portable Air Scrubber

The new, state-of-the-art rotational-molded HEPA filtration systems.



- High-density polyethylene cabinet is strong and durable; resin includes microbial growth and UV inhibitors
- Powerful — provides more airflow per pound than other products
- Lightweight (70 lbs) and portable, superior mobility for vehicle loading / unloading and easy-rolling to the job site
- Low-amperage draw, safely 'daisy-chain' up to three units on one 115V / 15-Amp circuit
- True 99.97% HEPA filtration, Type A HEPA tested and certified to IEST construction and testing standards; microglass media does not rely on an electrostatic charge to maintain efficiency; two pre-filter stages; optional third stage
- Economical to operate

Part #	Description	List Price
8.697-384.0	Predator 1200 Portable Air Scrubber	\$6,958.31

Predator 600 Portable Air Scrubber

The world's lightest and smallest PAS with the performance and features you need.



- INCREDIBLY LIGHTWEIGHT AND COMPACT – Weighs just 34 lbs. including filters — about 10 pounds lighter than any other PAS
- POWERFUL – Variable-speed airflow, rated at 200 to 600 cfm. PRED 600 is the smallest 600 cfm unit on the market
- SPECIAL CABINET RESIN – Cabinets made from a high-density polyethylene resin that contains microbial growth and UV inhibitors. And, the Tefgard™ finish is easy to clean and decontaminate
- EFFECTIVE FILTRATION – Comes with two pre-filters and a true 99.97% HEPA filter. Vapor-Lock® carbon pre-filter is optional
- ECONOMICAL TO OPERATE – Filters last longer and cost less — you can save hundreds of dollars in replacement filter costs
- SECURE STACKING – Multiple units nest securely together to save space when stacked in a warehouse, a van, or on the job. They can even run when stacked
- LOW-AMPERAGE DRAW, – Up to five units can be safely daisy-chained on one 15-Amp circuit (total current draw 12 Amps).

Part #	Description	List Price
8.697-385.0	Predator 600 Portable Air Scrubber	\$4,032.36

ZipWall Foam Rails and T-Clips



Foam rail cross bars and t-clips.

- Two foam rails and two T-clips
- Foam rails safely press plastic sheeting against ceiling

Part #	Description	List Price
8.697-367.0	ZipWall Foam Rails and T-Clips	\$91.07

ZipWall 12' Poles – 2/pk

Two spring-loaded poles, extends from 4'-7" to 12', includes two sets of parts (head, plate, tether, GripDisk™).



- The six SLP™ poles extend from 4'-9" to 12'
- The poles can be placed 8 to 10 feet apart. If there is any significant air movement that pushes the plastic, you will want to pull them in closer together
- The GripDisk™ slide stoppers should always be used, especially on hard surfaces
- Six GripDisk™ slide stoppers come in every package

Part #	Description	List Price
8.697-368.0	ZipWall 12' Poles 2/pk	\$318.21

ZipWall – 4/pk Plus

Four spring-loaded poles, four sets of parts (head, plate, tether, GripDisk™), two foam rails, box of two standard zippers, one carry bag.



- The four SLP poles extend from 4' 9" to 12'
- Snap foam rail on to the pole
- Each foam rail is five feet long
- The GripDisk™ should always be used especially on hard surfaces

Part #	Description	List Price
8.697-161.0	ZipWall 4/pk Plus	\$1,066.57

ZipWall Carrier Bag

Sturdy, durable. Can hold 12 SLPs or six 20' poles with jacks unattached.



- Made of tough polyester
- Keeps all your barrier products organized and easy to transport
- Holds the 20 foot pole and the red jack unattached

Part #	Description	List Price
8.697-366.0	ZipWall Carrier Bag	\$209.07

ZipWall Kit 20

Two poles that extend from 6'-9" to approximately 21'. Includes two jacks and two sets of parts (head, plate, tether, GripDisk™).



- The Kit 20 poles extend from 6'-9" to 20'
- This product can be used in areas with a ceiling height up to 21'
- The poles can be placed 8 to 10 feet apart. If there is any significant air movement that pushes the plastic, you will need to pull them in closer together, anywhere from 4 to 8 feet.
- Two GripDisk™ slide stoppers come in every Kit 20 package

Part #	Description	List Price
8.697-371.0	ZipWall Kit 20	\$661.83

ZipWall GripDisks – 2/pk



Holds bottom of poles securely in place on floors with slick surfaces such as linoleum, marble, or wood.

Part #	Description	List Price
8.697-362.0	ZipWall GripDisks 2/pk	\$23.23

ZipWall Side Clamp – 2/pk

Two side-clamp wall mounts.



- Each side-clamp wall mount is made of polycarbonate and is very tough
- This product can easily fit into the ZiWall® carry bag with poles and Foam Rail™ cross bars
- In some situations where you have large crown moldings and base board heat on the same wall, the pole may be too far from the wall for the side-clamp wall mounts to reach

Part #	Description	List Price
8.697-365.0	ZipWall Side Clamp 2/pk	\$168.71

ZipWall Zipper

Includes two self-adhesive zippers and two cords for tying up a plastic flap. For indoor-use only.



- Makes an easy doorway through plastic barriers
- Designed by the manufacturers of the award-winning ZipWall® dust barrier systems
- Has the smoothest glide available
- Is engineered with large, sturdy easy-slide teeth
- Is made with two-sided pulls for easy entry / exit to or from the barrier
- Works best in temperatures above 55°F

Part #	Description	List Price
8.697-363.0	ZipWall Zipper	\$62.72

Pressurized Drying System-21

Viking's new patent-pending pressurized drying system makes drying wall cavities easier and less frustrating than before.



Perfect for under sinks, behind cabinets and permanent furniture. Its portability makes drying a breeze. All-in-one containment provides the operator with simple on-the-go equipment. Just bore a 1/2" hole, plug in the end hose and begin drying. An on-board plug-off system makes plugging unused tubes simple.

Part #	Description	List Price
8.697-129.0	Pressurized Drying System-21	\$1,799.87

Legacy Air Mover (LAM3)

Powerful up to 3000 CFM, lightweight, versatile three-speed air mover reduces carpet drying times by up to 50%.



- Durable polyethylene gray housing with a sturdy four-point motor mount
- Easy to carry and move. Lightweight with a balanced offset handle
- 120V AC, 60hz, 9 Amp, with molded cord hooks for storing the 25' 16/3
- 1/2 HP thermally protected continuous duty motor with capacitor start and four-point mount
- Built-in carpet clip makes it easy to dry floors under carpet — ideal for restoration work

Part #	Description	List Price
1.004-014.0	Legacy Air Mover	\$278.10

Air King Pivoting High-Velocity

The Pivoting Blowers are a perfect fit for any job site. The compact size makes them a great fit where space is tight.



- The Pivoting High-Velocity Blower features a pivoting head to direct air flow where you need
- With a type SO, GFCI power cord with test and reset buttons
- The 1/13 HP blower delivers just the amount of air flow you need
- Dimensions: 13"L x 11"W x 14.5" Weight: 12.75 lbs.

Part #	Description	List Price
8.697-205.0	Air King Pivoting High-Velocity	\$165.00

Carpet Installation and Repair

Action Knife

Safety, convenience and precision are built in to this Action Knife.



- Save time and energy with this Action Knife's patented D-Ring front-loading blade change
- Angled design offers better control, and the handle acts as storage for additional blades
- 12 knives per box
- Uses 8.697-340.0 Replacement Blades

Part #	Description	List Price
8.697-053.0	Action Knife	\$21.68

Aluminum Straight Edge

36" aluminum straight edge.



- Grooved bottom helps to prevent slipping
- Anodized-finish guards against damage

Part #	Description	List Price
8.697-069.0	Aluminum Straight Edge	\$66.70

Aviation Snips for Most Metals

A high-quality, imported 10" snips with alloy steel handles.



- Alloy steel handles
- Hot-forged molybdenum steel blades
- Makes straight cuts 1-1/2" long in metal up to 18 gauge (.049") thick
- Vinyl grips for comfort

Part #	Description	List Price
8.697-068.0	Aviation Snips	\$22.36

Base Molding and Tackstrip Lifter

Gives positive leverage control to avoid denting the baseboard.



- Notches for nail and brad pulling
- Rust and chip-proof finish

Part #	Description	List Price
8.697-054.0	Base Molding and Tackstrip Lifter	\$21.17

Carpet Gripper

The harder the pull, the tighter the grip.



- Easily handles carpet from edges with strong gripping control
- Tear out carpet and vinyl with ease
- Six per box

Part #	Description	List Price
8.697-056.0	Carpet Gripper	\$64.22

Carpet Shears Bent Handle

Shears made for the most demanding of jobs.



- Entirely made in the U.S.A.
- Shears are hot-hammer-forged of high-integrity cutlery steel
- Hardened and tempered for durability and long life
- Shears are plated for superior protection against rust and corrosion
- Unconditional lifetime warranty against defective materials or workmanship
- A fully-warranted factory reconditioning is available for a charge for the life of the shears

Part #	Description	List Price
8.697-016.0	Carpet Shears Bent Handle (10")	\$143.87
8.697-017.0	Carpet Shears Bent Handle (8")	\$144.90

Duckbill Napping Shears

Unique duckbill blade designed for precision cuts. 7"



- Offset handle for easy-level nap trimming.

Part #	Description	List Price
8.697-060.0	Duckbill Napping Shears (7")	\$30.17

Carpet Repair Kit

Quick, neat and simple tool for professional carpet repairs.



- Utilizes remnants or carpet from hidden areas, such as closets
- Perfect for burns, stains, rips, tears and other small damage
- Includes six Insta-Hold™ pressure-sensitive patches
- Six per box

Part #	Description	List Price
8.697-045.0	Carpet Repair Kit	\$27.36

Carpet Repair Replacement Blades



- Replacement blades for the Cookie Cutter Repair Tool
- 10 per pack

Part #	Description	List Price
8.697-340.0	Carpet Repair Replacement Blades	\$18.33

Door Hinge Pin Remover

This tool removes door pins fast and easy without causing damage.



- Forked-end fits snugly around the head of the pin so that equal pressure is applied to both sides

Part #	Description	List Price
8.697-067.0	Door Hinge Pin Remover	\$78.99

Carpet Wall Trimmer

Plastic-protected wall guide.



- New non-slip color handle and improved performance
- Cuts in either direction

Part #	Description	List Price
8.697-064.0	Carpet Wall Trimmer	\$160.04

Cushion Back Cutter

For top-cutting and trace-cutting.



- Patented D-ring for easy blade change
- 30° blade angle provides clean cuts the first time
- Six per box

Part #	Description	List Price
8.697-046.0	Cushion Back Cutter	\$36.19

Loop Pile Cutter

Designed specifically for loop pile and berber carpet.



- Patented D-ring for easy blade change.
- 30° blade angle provides clean cuts the first time.
- Six per box

Part #	Description	List Price
8.697-047.0	Loop Pile Cutter	\$81.31

Fast Lock Edge Sealer

Allows installer to see adhesive application to carpet's edge.



- Convenient 8 oz. bottle
- Cap has a longer lip than competing products
- 12 per case

Part #	Description	List Price
8.697-059.0	Fast Lock Edge Sealer	\$13.47

Electric Glue Gun

For hard-to-reach seam locations and patch repairs.



- Specially-designed drip-resistant tip
- Fast heat-up with 80 watts delivers temperatures to 380°
- Includes alternate extension

Part #	Description	List Price
8.697-050.0	Electric Glue Gun	\$60.09

Glue Sticks – 30/pk

- 4" / 30 per bag — fits most glue guns
- Includes fluorescent material which reflects black light for easy steam inspection

Part #	Description	List Price
8.918-116.0	Glue Sticks 30/pk	\$34.21

Installer's Carpet Kicker

Thicker, more comfortable knee pad. Smooth glide action.



Part #	Description	List Price
8.697-052.0	Installer's Carpet Kicker	\$251.93

Power Stretcher

Standard stretcher with box.



- The Power Stretcher features a 12" head, heavy-duty steel teeth and adjustable height
- The four inner-outer steel tubing sections are made of a thick gauge steel and have a large diameter for strength and rigidity
- The Power Stretcher includes the 20" Rol-A-Block tail block assembly, one 14" connecting tube, an adjustment neck tube and a durable plastic case
- The Power Stretcher tubes have a large diameter for extra strength to reduce bowing on long stretches
- The Power Stretcher case is made of durable molded plastic for easy stretcher transport. Reinforced-steel, double hinges and heavy-duty clasps. Fits all Taylor power stretchers.

Part #	Description	List Price
8.697-424.0	Power Stretcher	\$1,570.43

Kool Top Seaming Iron

Fully grooved, featuring ORCON's chevron pattern. Channels adhesive into the patented deep-center groove.



- 'Butters' the seam edges which helps prevent seam hinging and peaking (see Peak-Buster™ products).
- Now features 15 ft. cord!

Part #	Description	List Price
8.697-051.0	Kool Top Seaming Iron	\$340.73

Seam-Mate Iron Box

For seaming iron, tape and tools.



- Features hinged shelf
- Will hold two (2) irons (wide and narrow) and a roll of standard seaming tape!

Part #	Description	List Price
8.697-043.0	Seam-Mate Iron Box	\$187.92

Seam Roller by Action

This Action Seam Roller has specially-designed beveled star wheels to deeply press the carpet backing into the adhesive.



- Designed for use on loop pile carpet to eliminate yarn

Part #	Description	List Price
8.697-010.0	Seam Roller by Action	\$39.08

Smooth Action Roller

Smooth wheels provide safe seam finishing for plush cut piles and saxonomies, without face yarn damage or tractor marks.



- Forces hot-melt adhesive into carpet backing for added seamstrength
- Designed for cut-pile carpet. Six per box

Part #	Description	List Price
8.697-057.0	Smooth Action Roller	\$29.53

Stair Tool – T-Handle

Patented handle allows for better grip and tool control.



- Less impact on wrist and hand
- Ideal for hooking on tack strip
- Chrome finish to protect against corrosion

Part #	Description	List Price
8.697-063.0	Stair Tool – T-Handle	\$63.81

Stair Tool – Cushion-Handle



- Improved cushion grip prevents slipping
- Cushion grip reduces shock to hand
- Rounded corners and edges protect against snags and tears

Part #	Description	List Price
8.697-062.0	Stair Tool – Cushion-Handle	\$27.88

EZ Moves 4' Furniture Slide

Allows easy movement of furniture on either hard or soft surfaces.



- Ideal for moving appliances, filing cabinets, stacks of boxes and other large, bulky items on hard surface floors

Part #	Description	List Price
8.697-025.0	EZ Moves 4' Furniture Slide	\$33.45

EZ Moves Pro

Set of four.



- Used by moving men, carpet installers, carpet cleaners, painters, remodelers, store owners, janitorial services, interior designers and more

11.5" x 6.75"

Part #	Description	List Price
8.697-027.0	EZ Moves Pro	\$86.01

EZ Moves Hard Surface Pro

For heavy moving on hard floors (4/pkg).



- An accessory for your EZ Moves II™ to provide extra protection when moving items across hard surfaces

5-3/4" x 9-1/2"

Part #	Description	List Price
8.697-026.0	EZ Moves Hard Surface Pro	\$45.84

Instant Hold Replacement Disks

Replacement disks for the cookie-cutter repair tool.



- A must-have for the carpet repair professional
- 100 disks per pack

Part #	Description	List Price
8.697-343.0	Instant Hold Replacement Disks	\$116.67

Swivel Tool Pocket

This heavy-duty pocket is made for the professional.



- Pocket is lined for blade and tool protection
- Genuine leather with heavy-duty riveting
- Six per box

Part #	Description	List Price
8.697-055.0	Swivel Tool Pocket	\$78.01

Chalk Reel

50' long Chalk Line Reel



- Economically priced durable aluminum alloy box
- Easy-to-hold sure-grip shape
- Fill by simply sliding open the nylon cover
- Self-locking handle and a plated anchor ring
- Cotton line is highly absorbent for positive marking, and is replaceable.
- Can also be used as a plumb bob

Part #	Description	List Price
8.697-065.0	Chalk Reel	\$5.58

White Chalk

8 oz Refill Bottle.



- A specially-formulated blend of talcum powder and limestone is milled to a finer consistency for more positive and distinct marking
- Available in an 8 oz squeeze bottle with an easy-fill spout

Part #	Description	List Price
8.697-066.0	White Chalk	\$11.67

Perfect Patch

Easiest way to repair carpet.



- The 3-in-1 Perfect Patch tool is the easiest way to repair carpet and it comes with a FREE how-to-patch a carpet video!

Part #	Description	List Price
8.697-392.0	White Chalk	\$76.97

Hoses, Connectors and Accessories

Ball Shut-Off Valve 1/4"

Replacement Econo shut-off valve.



- Use this ball valve on your solution hose
- Fits 1/4" fittings

Part #	Description	List Price
8.697-347.0	Ball Shut-Off Valve 1/4"	\$7.02

Premium Ball Shut-Off Valve

Replacement shut-off ball valve.



- Premium quality built into this shut-off valve

Part #	Description	List Price
8.697-126.0	Premium Ball Shut-Off Valve (3/8")	\$39.46
8.697-125.0	Premium Ball Shut-Off Valve (1/4")	\$13.92

Chrome Ball Valve



- 1000 PSI
- 300° M/F
- "T"-handle valve

Part #	Description	List Price
8.697-414.0	Chrome Ball Valve – 1/4"	\$14.49

Connector 1.5"-2" Stainless-Steel

Durable stainless-steel vacuum hose connector.



- Connects 2" vacuum hose cuff to 1.5" hose cuff

Part #	Description	List Price
8.697-076.0	Connector 1.5"-2" Stainless-Steel	\$22.51

Connector 1.5" Stainless-Steel

Durable stainless-steel vacuum hose connectors for connecting two lenth of 1.5" vacuum hose.



- Connects two sections of 1.5" vacuum hose

Part #	Description	List Price
8.697-075.0	Connector 1.5" Stainless-Steel	\$14.05

Connector 2" Stainless-Steel

Durable stainless-steel vacuum hose connectors for connecting two lenth of 2" vacuum hose.



Part #	Description	List Price
8.697-078.0	Connector 2" Stainless-Steel	\$17.50

Connector 2" Stainless-Steel 'Y' Vac

Vacuum hose "Y" — 2" stainless-steel hose connector.



- Use two wands on a single-wand machine
- Durable stainless-steel for long wear

Part #	Description	List Price
8.697-123.0	Connector 2" Stainless-Steel 'Y' Vac	\$55.94

Connector: Barb Hose 2"-1.5"

1.5" barb x 2" barb.



Part #	Description	List Price
8.697-348.0	Connector: Barb Hose 2"-1.5"	\$28.77

Connector: Barb Hose 1.5"-1.5"

1.5" barb x 1.5" barb connector.



Part #	Description	List Price
8.697-345.0	Connector: Barb Hose 1.5"-1.5"	\$13.51

Connector: Barb Hose 2"-2"

2" barb x 2" barb connector.



Part #	Description	List Price
8.697-346.0	Connector: Barb Hose 2"-2"	\$13.21

Coupler: 1/4" Female, Secure Lock



Part #	Description	List Price
8.697-085.0	Coupler: 1/4" Female, Secure Lock	\$16.72

Coupler: 1/4" Female

Parker quick-connect.



Part #	Description	List Price
8.697-079.0	Coupler: 1/4" Female	\$15.63

Coupler: 1/4" Female Stainless-Steel

Durable stainless-steel female replacement coupler.



Part #	Description	List Price
8.697-087.0	Coupler: 1/4" Female Stainless-Steel	\$30.17

Coupler: Quick Connect 1/4" F Econo



Female 1/4" econo replacement QD.

- Interchangeable with other manufacturers' fittings

Part #	Description	List Price
8.697-350.0	Coupler: Quick Connect 1/4" F Econo	\$16.38

Coupler: 1/4" Male Quick-Connect Econo



Coupler 1/4" male quick-connect, economy.

- Directly interchangeable with your worn out brass or stainless-steel couplers

Part #	Description	List Price
8.697-080.0	Coupler: Quick-Connect 1/4" M Econo	\$8.12

Coupler: 1/4" Male Stainless-Steel



Parker Hannifin coupler 1/4" male quick-connect.

Part #	Description	List Price
8.697-086.0	Coupler: 1/4" Male Stainless-Steel	\$18.88

Coupler: 1/4" Male Quick Connect PH

High-quality, long-life Parker Hannifin brand coupler.



Part #	Description	List Price
8.697-081.0	Coupler: 1/4" Male QC PH	\$5.49

Hide-A-Hose Swivel Cuff

Vinyl hide-a-hose swivel cuff.



- Now you can hide your solution hose within the vacuum hose line, and you can forget the hassles of trying to work with separate hoses lying all around!

Part #	Description	List Price
8.697-351.0	Hide-A-Hose Swivel Cuff (2")	\$38.61
8.697-349.0	Hide-A-Hose Swivel Cuff (1.5")	\$12.26

Swivel Cuff: Big End Threaded



Part #	Description	List Price
8.708-903.0	Big End Threaded (1.5")	\$4.24
8.708-904.0	Big End Threaded (2")	\$6.57
8.708-905.0	Swivel Cuff (1.5")	\$3.78
8.708-906.0	Swivel Cuff (2")	\$6.83

Hose Cuff 1.5"-2" Small End Threaded



Vinyl enlarger.

- 1-1/2" vinyl screw cuff enlarged to accommodate
- 2" O.D. wand connection

Part #	Description	List Price
8.697-091.0	Hose Cuff 1.5"-2" Small End Threaded	\$4.24

Hose Cuff 2" Swivel Reducer

2" vinyl swivel reducer cuff.



Part #	Description	List Price
8.697-093.0	Hose Cuff 2" Swivel Reducer	\$7.76

Hose Cuff 2"-1.5" Both Ends Threaded

2"-1.5" vinyl double threaded connector.



Part #	Description	List Price
8.697-095.0	Hose Cuff 2"-1.5" BET	\$5.02

Misc. Hose Cuffs and Accessories

Part #	Description	List Price
8.708-896.0	Hose Connector 1.5"-1.5"	\$6.37
8.708-900.0	Hose Cuff 2" Threaded Reducer	\$7.40
8.708-898.0	Hose Cuff 2"-2" Both Ends Threaded	\$6.88

Hose Hook 1.5

Hose Hook 1.5" to 3".



- Hook: 1/4" dia., 1-1/4" radius bend (2-1/2" opening)
- Can hook on larger objects
- Coated to prevent scratches
- Fits 1-1/2" to over 3" hoses

Part #	Description	List Price
8.697-100.0	Hose Hook 1.5	\$14.54

Hose Hugger 3 x 27

3 x 27" for 25' + of 1-1/2" vacuum hoses.



Part #	Description	List Price
8.697-122.0	Hose Hugger 3 x 27	\$6.88

Hose Hugger 3 x 34

3 x 34" for larger diameter vacuum hoses.



Part #	Description	List Price
8.697-121.0	Hose Hugger 3 x 34	\$8.37

Cord Hugger 3 x 12

For light-duty electric cords up to 100'.



- Clear the clutter and tangles with this handy accessory.

Part #	Description	List Price
8.697-120.0	Cord Hugger 3 x 12	\$6.16

D-Ring Handi Tie 1.5

An all-purpose tie for power cords and solution hoses. Keeps them with the tool or appliance.



Part #	Description	List Price
8.697-099.0	D-Ring Handi Tie 1.5	\$2.53

QD Connector Sleeve Set



To protect you and your customers.

- Covers the hot metal ends of your hose to prevent burns and damage to you and your customer
- Helps to protect brass fittings for longer life

Part #	Description	List Price
8.697-077.0	QD Connector Sleeve Set	\$12.06

Snap N Lock Cuff

Snap N Lock hose connector set.



- Stainless-steel button locks
- Positive locked connection
- High-impact, safety-yellow plastic
- Durable in hot or cold climates
- Fracture-resistant

Part #	Description	List Price
8.697-408.0	Snap N Lock Cuff (1.5"-1.5")	\$25.67
8.697-410.0	Snap N Lock Cuff (2"-1.5")	\$16.72
8.697-407.0	Snap N Lock Cuff (2"-2")	\$12.26

Snap N Lock Cuff 2"

Snap N Lock 2" leaf trap adapter.



- Stainless-steel button locks
- Positive locked connection
- High-impact, safety-yellow plastic
- Durable in hot or cold climates
- Fracture resistant

Part #	Description	List Price
8.697-409.0	Snap N Lock Cuff 2"	\$16.72

Tandem Hose Clamp

For keeping hoses connected.



- Tandem hose clamp 2" wide strap
- Adjustable

Part #	Description	List Price
8.697-101.0	Tandem Hose Clamp	\$36.02

Hose Buddy

Save your hands from hot hoses.



- A patented, fully-engineered tool designed to separate operator's hands from hot, abrasive hoses during hose retrieval process
- Saves time by providing accurate, "friction-free" hose delivery on to reel
- Works on supply and delivery hoses up to 5/8"

Part #	Description	List Price
8.697-427.0	Hose Buddy	\$18.90

Solution Hose Reel

Solution reels provide convenient storage for high-pressure solution hose and garden hose.



- Will accommodate up to 150' of 5/8" garden hose or 450' for 1/4" high-pressure hose
- Standard solution reels come in two sizes and come equipped with an angle bracket that bolts directly on to our vacuum hose reels
- All welded-steel construction with rust-resistant paint finish make it an attractive asset to any truck-mounted cleaning system

Part #	Description	List Price
8.697-071.0	Solution Hose Reel (150' 5/8", 450' 1/4")	\$167.95
8.697-070.0	Solution Hose Reel (100' 5/8", 300' 1/4")	\$158.05

Solution Hose 50', 1/4" 3000 PSI

High-temperature, high-pressure solution hose.



- 50 feet, steel-braided
- Handles up to 250°F and 3,000 PSI
- Tight-bend radius capability
- 1/4" male swage fittings and a black poly heat shield

Part #	Description	List Price
8.918-062.0	Solution Hose – Blue	\$124.20
8.918-075.0	Solution Hose – Gray	\$124.20

Solution Hose 50', 1/4" 1500 PSI

High-temperature, high-pressure solution hose.



- 50 feet, gray, steel-braided
- Handles up to 250°F and 1,500 PSI
- Tight-bend radius capability
- 1/4" male swage fittings and a black poly heat shield

Part #	Description	List Price
8.918-074.0	Solution Hose – Blue	\$97.55
8.918-063.0	Solution Hose – Gray	\$74.93

Solution Hose 50', 3/8" Blue, 3000 PSI

High-temperature, high-pressure solution hose.



- 50 feet of 3/8" Goodyear high-pressure solution line, steel-braided
- For pressure washing or other equipment that requires more water flow
- 3000 PSI / 250°F
- Plastic heat sleeve

Part #	Description	List Price
8.739-148.0	Solution Hose – Blue	\$123.60

Truck-Mount Vacuum Hose

50 feet of 2.5" blue, heavy-duty truck-mount vacuum hose with cuffs.



- The combination of co-polymer materials and two-part helically-wound construction make this hose superior to others in the market
- Has all the characteristics users look for in a vacuum hose plus many added features such as ultraviolet protection, crush-resistance, smooth bore and much more

Part #	Description	List Price
8.697-400.0	Truck-Mount Vacuum Hose	\$216.83

Truck-Mount Hose, Heavy-Duty Gray

Hose, 25' or 50' heavy-duty, truck-mount vacuum hose, gray with cuffs.



- The combination of co-polymer materials and two-part helically-wound construction make this hose superior to others in the market
- Pro-Flex™ has all the characteristics users look for in a vacuum hose plus many added features such as ultraviolet protection, crush-resistance, smooth bore and much more.

Part #	Description	List Price
8.697-113.0	Truck-Mount Vacuum Hose (25', 1.5")	\$50.23
8.697-114.0	Truck-Mount Vacuum Hose (50', 1.5")	\$95.12
8.697-118.0	Truck-Mount Vacuum Hose (50', 2")	\$147.00

See page 20 for additional Hose offering

Truck-Mount Hose, Heavy-Duty Blue

Hose, 25' or 50' heavy-duty, truck-mount vacuum hose, blue with cuffs.



- The combination of co-polymer materials and two-part helically-wound construction make this hose superior to others in the market
- Pro-Flex™ has all the characteristics users look for in a vacuum hose plus many added features such as ultraviolet protection, crush resistance, smooth bore and much more

Part #	Description	List Price
8.697-111.0	Truck-Mount Vacuum Hose (25', 1.5")	\$50.23
8.697-112.0	Truck-Mount Vacuum Hose (50', 1.5")	\$95.12
8.697-117.0	Truck-Mount Vacuum Hose (50', 2")	\$95.12

Vacuum Hose Reel

These storage reels offer the advantage of using a reel as an effective piece of operating equipment rather than a simple device for the storage of hose.



- All storage reels feature custom-fabricated UHMW bearings. UHMW is a plastic compound that will provide trouble-free service
- All reels are pre-drilled to accept our solution reels which are simply bolted on
- All reels are equipped with a positive spool stop
- All reels are welded-steel construction and finished with rust-resistant paint

Part #	Description	List Price
8.697-072.0	Vacuum Hose Reel – 200'	\$552.45
8.697-073.0	Vacuum Hose Reel – 250'	\$558.25
8.697-074.0	Vacuum Hose Reel – 300'	\$562.60

Vacuum Hose Shelf Hook



4.5" vacuum hose shelf hook.

- For straight-sided shelves 4-1/4", plated to prevent rust

Part #	Description	List Price
8.697-102.0	Vacuum Hose Shelf Hook	\$11.18

Vinyl-Coated Wand Hook



- 2-1/2" wand / utility hook for chemical shelves
- Vinyl-coated to avoid scratching and rust

Part #	Description	List Price
8.697-103.0	Vinyl-Coated Wand Hook	\$11.18

Faucet Kit Adapter



- Universal faucet adapter

Part #	Description	List Price
8.697-406.0	Faucet Kit Adapter	\$44.76

Double Hose Reel Stand

Self-supporting, dual hose reel stand.



- Dual stand
- Self-supporting
- Provides more hose capacity than the single stand
- Also permits independent live operation of the reels

Part #	Description	List Price
8.697-419.0	Double Hose Reel Stand	\$81.40

Hose Reel Stand

Self-supporting, hose reel stand.



- Single stand
- Can be used to make reel portable or to simplify installation
- Self-supporting
- Also accommodates live operation of the reel

Part #	Description	List Price
8.697-420.0	Hose Reel Stand	\$169.74

Stack Bracket

Stack bracket for solution hose.



- Mounts to either side of vacuum storage reel
- Stack bracket will not add to the overall dimensions of the vac reel
- Allow space-saving convenience of double stacking two solution reels on same side of the vacuum reel

Part #	Description	List Price
8.697-421.0	Stack Bracket	\$231.84

Swivel Assembly

Convert standard solution reel to live storage.



- 3/8" swivel
- 3/8" hose
- Fittings to attach hose

Part #	Description	List Price
8.697-423.0	Swivel Assembly	\$231.84

Brushes

Large Horsehair Brush

Heavy-duty horse hair brush.



- Use these densely-filled, quality horse hair brushes for your furniture cleaning needs
- Horse hair brushes absorb and hold cleaning solution better than any other brush

Part #	Description	List Price
8.697-321.0	Large Horsehair Brush	\$74.13

Nap Brush

Nylon, white, stiff napping brush.



- Used to remove swirl marks from the rotary action of machines, foot prints, or even wheel tracks from equipment
- Shade the nap in one direction to give the carpet a neat, finished appearance
- Featherweight brush is 19" wide with three rows of 1-1/2" long nylon bristles
- Designed to not streak
- Nap brush is very strong, yet lightweight, which eliminates job fatigue and helps the job go faster

Part #	Description	List Price
8.697-320.0	Nap Brush	\$33.45

Brass Velvet Brush

Brass velvet groomer with wooden handle.



- Traditional-style velvet groomer which has been used for years
- Brass wire attached to a maple wooden handle

Part #	Description	List Price
8.697-289.0	Brass Velvet Brush	\$21.53

Swivel Grout Brush

Swivel grout brush 1" X 8".



- The fibers on this brush are trimmed to a chisel edge to allow the brush to scrub aggressively along grout lines
- The stiff black fiber will stand up to tough use
- Uses standard-threaded handle (not included)

Part #	Description	List Price
8.697-287.0	Swivel Grout Brush	\$11.14

Groomers

Grandi Brush

Designed to give maximum penetration on commercial-grade level and multi-loop carpets.



- The Grandi Brush features a single row of nylon fibers that have been designed to give maximum penetration on commercial-grade level and multi-loop carpets
- You can agitate pre-sprays as well as protectors to get optimum performance from your carpet cleaning chemicals

Part #	Description	List Price
8.697-009.0	Grandi Brush	\$37.52

Grandi Brush (Head Only)

No Handle.



Part #	Description	List Price
8.697-011.0	Grandi Brush (Head only)	\$69.50

Grandi Groom

Perfect for multi-level carpet pile.



- 18" wide head
- Ideal for agitating pre-spray into the carpet
- Excellent for working protector into the carpet

Part #	Description	List Price
8.697-012.0	Grandi Groom	\$33.02

Grandi Groom (Head Only)

No Handle.



Part #	Description	List Price
8.697-019.0	Grandi Groom (Head only)	\$26.34

Grandi Groom Conversion

Convert your Grandi Groom to include the Grandi Brush head.



- The Grandi-Groom Conversion Kit consists of the Grandi Brush head with dual-head connector to attach to your existing Grandi Groom to create a two-headed grooming tool
- The Grandi Brush features a single row of nylon fibers that have been designed specifically to give maximum penetration on commercial grade level and multi-loop carpets
- You can agitate pre-sprays as well as protectors to get optimum performance from your carpet cleaning chemicals
- The Grandi Brush can be combined with the classic Grandi Groom to create the Grandi / Brush Combo
- With the conversion kit, you can create a two-headed grooming tool that adapts easily to any type of carpet

Part #	Description	List Price
8.697-013.0	Grandi Groom Conversion	\$86.84

Handi Brush

This short soft bristle brush is excellent for upholstery, velvet, oriental rugs or any other fine fabric.



- Use before cleaning to lift nap and remove lint, pet hair or other debris
- Use after cleaning to lift nap

Part #	Description	List Price
8.697-014.0	Handi Brush	\$14.02

Handi Groom Brush

Plastic bristles agitate pre-spray and protectants on stairs and hard-to-reach areas. Ideal for use in spot dyeing.



- Lightweight plastic bristle hand brush designed as a pile conditioner for carpeting on stairs and in tight places
- Excellent for restoring the appearance and texture of high-pile area rugs, fringes, even sweaters
- Compact and handy, but strong enough for stubborn dirt

Part #	Description	List Price
8.697-015.0	Handi Groom Brush	\$12.89

Containers

EZ Fill Container

5-gallon head pack.



- User-friendly for EZ filling and pouring
- Heavy-duty container, 63mm-angled front opening for filling of ready-to-use chemical concentrates, 38mm top vent opening accepts standard and three-quarters in tubing
- Includes faucet with 38mm cap
- No-leak design
- Tight fit with easy on/off handle
- Spout fits into 28mm bottle neck, no spilling and a half-gallon embossed graduations on top and front

Part #	Description	List Price
8.697-313.0	EZ Fill Container	\$59.41

Measuring Cups

End the guessing game.



- Cups are calibrated for exact measurements

Part #	Description	List Price
8.697-021.0	Measuring Cups – 16 oz	\$3.16
8.697-024.0	Measuring Cups – 8 oz	\$1.76
8.697-023.0	Measuring Cups – 4 oz	\$1.09

Measuring Cups – 2 oz



Part #	Description	List Price
8.697-022.0	Measuring Cup – 2 oz	\$0.36

Spigot for 5 Gallon



Replacement spigot.

- The quick-serve spigot dispenses water for hand and body washes
- White color
- USA made

Part #	Description	List Price
8.697-279.0	Spigot for 5 Gallon	\$5.29

Spotting Bottle

Plastic spotting bottle with lid.



- Sprayer bottles and sprayers are perfect for chemicals and cleaners.

Part #	Description	List Price
8.697-006.0	Spotting Bottle – 32 oz	\$2.15
8.697-035.0	Spotting Bottle –16 oz	\$3.05
8.697-007.0	Spotting Bottle – 4 oz	\$1.04

Bucket 10-Quart

10-quart heavy-duty bucket.



- 10-quart pail with pour spout
- Grooved bottom and metal bail handle for easy grip
- Embossed graduations

Part #	Description	List Price
8.697-297.0	Bucket 10-quart	\$12.26

Misc. Accessories

Wall Buddy

The ultimate solution in corner protection.



- Can be used in the carpet cleaning-, janitorial-, and painting-industries
- Protects all of the corners of the walls and furniture on your job
- Portrays a professional image which reassures your customer that you care
- Protects against costly insurance claims due to damaged corners or walls
- Made from a lightweight, non-marking durable plastic
- Can be sold to customers who have central vacuum systems

Part #	Description	List Price
8.697-425.0	EZ Fill Container	\$9.26

Drum Pump

Siphon drum pump.



- Made from polyethylene
- Fits 15-, 30- and 55-gallon drum with 2" national pipe thread

Part #	Description	List Price
8.704-696.0	Drum Pump	\$19.88

Strainmaster

Stainless-steel Strainmaster.



- Fits Filtermaster

Part #	Description	List Price
8.697-404.0	Strainmaster	\$46.32

Sticky Tabs

3 x 3.5" tabs. Approximately 340 tabs to a roll. 24 rolls/case.

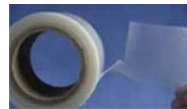

- No more hard-to-reach places
- Easily apply tacky side up to legs / feet of furniture, then slide back into original position
- Protects you and your customers

Part #	Description	List Price
8.697-032.0	Sticky Tabs	\$465.75

Styrofoam Blocks – Blue

Premium blue styrofoam blocks. The best block money can buy!



- Blue blocks are the very best, especially for the heaviest furniture
- These 2" x 2" x 1" blocks have the highest compressive strength available and will never crush
- Will never leave a mess as it always snaps off cleanly
- 1,008 per case

Part #	Description	List Price
8.697-001.0	Styrofoam Blocks – Blue	\$63.71

Styrofoam Blocks – White

White styrofoam, 2.0 PSI. 1,008 per case!



Part #	Description	List Price
8.697-003.0	Styrofoam Blocks – White	\$60.35

Plastic Protector Pads – 1000/cs

Furniture protection solution.



- The solution for protecting furniture legs from moist carpet
- Each box contains two blocks of 425 and one block of 150
- Clear plastic, completely moisture-proof

Part #	Description	List Price
8.697-028.0	Plastic Protector Pads 1000/cs – 3 x 3	\$10.33
8.697-030.0	Plastic Protector Pads 1000/cs – 4 x 4	\$20.51

Lift Buddy

One-person lifter.



- Strong, metal lift designed to give you the leverage you need to easily lift the corners of any type of furniture
- Takes the strain off of your back and allows you to lift even the heaviest pieces of furniture
- Allows cleaners to lift furniture with one hand, leaving the other hand free to place skidders, blocks or tabs under the furniture legs
- Protects you from costly medical expenses and time off the job due to injuries and saves on workers compensation
- Makes you a professional among professionals, showing clients you take care of your health
- A one-person tool — lightweight, yet heavy-duty
- Great for rearranging furniture and for floodwork

Part #	Description	List Price
8.697-426.0	Lift Buddy	\$60.39

Measuring Wheel

Keson Road Runner measuring wheel.



- Easy-to-measure curved, horizontal and asymmetrical surfaces. Weighs less than two pounds
- Five-digit, easy-read, magnified counter measures 9,999'-11" without resetting. That's almost two miles!
- Handle telescopes down to 17", fitting into a toolbox or briefcase and extends up to 38" when measuring

Part #	Description	List Price
8.697-401.0	Measuring Wheel	\$44.66

Bonnet Carpet



- Low-profile bonnets
- Scrubs aggressively and provides maximum absorption
- Thousands of low-profile loops trap the released soil
- Two-sided and may be laundered many times for maximum wear life
- Highest quality available

Part #	Description	List Price
8.697-335.0	Bonnet Carpet – 17"	\$72.58
8.697-336.0	Bonnet Carpet – 19"	\$100.05

Carry-All Tray

Tray to organize and carry tools and solutions.



- Heavy-duty construction
- High sides prevent bottles from falling over
- Tan in color

Part #	Description	List Price
8.697-308.0	Carry-All Tray	\$37.52

Carry-All Tray Inserts



- Inserts to help hold quart bottles, aerosols, etc.
- Tan in color

Part #	Description	List Price
8.697-273.0	Carry-All Tray Inserts	\$4.40

Cool-Wrap Wand

Cool-wrap for your wand.



- A heat-barrier handle for the lower portion of the wand that operator can grab when cleaning stairs or a riser with the wand or stair tool
- Wand wrap protects your hand from heat when doing stairs or just holding the wand

Part #	Description	List Price
8.697-403.0	Cool-Wrap Wand	\$16.73

Safety Items

Boot Hazmat / Flood

Yellow hazmat / flood boots.



- Great foot protection against muddy and watery conditions in many different types of environments and workplaces

Part #	Description	List Price
8.697-131.0	Boot Hazmat / Flood – XL	\$60.03
8.697-132.0	Boot Hazmat / Flood – XXL	\$60.03

Booty Boots

Heavy-duty reusable boot covers.



- Non-disposable
- Machine-washable
- Static-free
- Water-, slip- and scuff-resistant shoe or boot covers for professionals!

Part #	Description	List Price
8.697-391.0	Booty Boots	\$76.97

Dust Mask

White cone mask with elastic, non-rated.



- 50/Box = 20 boxes/cs

Part #	Description	List Price
8.697-149.0	Dust Mask	\$7.76

Knee Pads



Save your knees — buy these.

- One size fits all
- Quality construction with comfort in mind
- Quick-release snaps

Part #	Description	List Price
8.697-150.0	Knee Pads	\$22.36

Disposable Nitrile Gloves

Powdered, nitrile disposable gloves.



- Powdered, nitrile, rolled cuff
- Meets FFDC requirements for food contact
- Ambidextrous
- Greater tactile feel over other latex alternatives
- 100 per box

Part #	Description	List Price
8.697-145.0	Disposable Nitrile Gloves – Large	\$17.85
8.697-146.0	Disposable Nitrile Gloves – Medium	\$17.85
8.697-147.0	Disposable Nitrile Gloves – XL	\$17.85

Vinyl Disposable Gloves

Seamless, vinyl, latex-free disposable gloves.



- Latex-free
- Meets FFDC requirements for safe food handling
- Ambidextrous
- Lightly powdered
- Rolled cuff
- 100 per box

Part #	Description	List Price
8.697-137.0	Vinyl Disposable Gloves – Large	\$11.18
8.697-148.0	Vinyl Disposable Gloves – Medium	\$11.18
8.697-138.0	Vinyl Disposable Gloves – XL	\$11.18

Nitrile Flock-Lined Gloves

Strong, chemical-resistant nitrile gloves. Price per dozen.



- Green 15 mil
- 12" nitrile flock lining
- Strong, chemical-resistant, including petroleum-based products
- Meets FFDC requirements for food contact

Part #	Description	List Price
8.697-143.0	Nitrile Flock Lined Gloves – Medium	\$22.41
8.697-144.0	Nitrile Flock Lined Gloves – XL	\$22.41

Maxshield Coveralls with Hood and Boots

Coveralls come complete with hood and elasticized boots.



Part #	Description	List Price
8.697-156.0	Coveralls w/ Hood and Boots – Medium	\$7.26
8.697-155.0	Coveralls w/ Hood and Boots – Large	\$7.26
8.697-157.0	Coveralls w/ Hood and Boots – XL	\$7.69
8.697-158.0	Coveralls w/ Hood and Boots – XXL	\$6.37

Shoe Covers – Blue

Large, 100% polypropylene, blue shoe covers.



- White tread for traction
- Elastic opening for a snug fit around the ankle

Part #	Description	List Price
8.697-431.0	Shoe Covers – Large, Box / 300	\$18.84
8.697-432.0	Shoe Covers – XL, Box / 300	\$22.36

Shoe Covers – White

200/cs.



Part #	Description	List Price
8.697-139.0	Shoe Covers – White	\$141.80

Safety Glasses / Amber

Amber lens safety glasses.



- These safety glasses are the next generation in super-cool, low-cost protective eyewear
- Ultra-fashionable impact protection that meets and exceeds ANSI Z87.1+ standards

Part #	Description	List Price
8.697-140.0	Safety Glasses / Amber	\$5.54

Safety Glasses / Clear

Clear lens, wrap-around safety glasses.



- Adjustable temples for length and flexibility
- Lightweight and comfortable to wear
- Meets Z87.1 safety standards

Part #	Description	List Price
8.697-142.0	Safety Glasses / Clear	\$3.69

Splash-Proof Safety Glasses

Chemical splash goggle.



- Frame material – PVC plastic
- Lens material – polycarbonate
- Lens coatings – Duramass® scratch-resistant hard coating)
- Lens thickness – .060mm
- Strap – rubber (rubber straps on the protective goggles are latex-free)
- Style – indirect ventilation for chemical splash
- Replacement lenses available
- All lenses provide 99.9% UV protection
- Meets or exceeds ANSI Z87.1+ safety standard
- Light transmissions – Clear – 85%

Part #	Description	List Price
8.697-141.0	Splash Proof Safety Glasses	\$8.90

Respirator, Full-Face

MSA full-mask respirator.



- The MSA reusable, full facepiece, offers users comfort and convenience as well as cost-savings
- The facepiece is made of a thermoplastic elastomer, making it remarkably comfortable, soft and lightweight
- This is the MSA full-face mask only, filters and cartridges sold separately

Part #	Description	List Price
8.697-370.0	Respirator Full-Face – Medium	\$497.84
8.697-369.0	Respirator Full-Face – Large	\$183.46

Respirator, Half-Face – Large

Advantage half-mask respirator, size large.



- Offers unmatched fit and comfort with a clear blue facepiece
- The thermoplastic rubber subtracts 25% of the weight and adds softness to MSA's Advantage 200 LS respirator
- The patented MultiFlex® System equalizes pressure on the face-seal area, while delivering exceptional stability so the respirator will not collapse during wear
- The AnthroCurve sealing surface instantly conforms to each wearer's unique facial characteristics. Current Advantage 200 respirator wearers require no additional fit testing

Part #	Description	List Price
8.697-152.0	Respirator Half-Face – Large	\$55.73

Organic Vapor Respirator Set Cartridge

Chemical cartridges for Advantage respirators.



- NIOSH-approved for respiratory protection against vapors
- Meets OSHA requirements for an approved cartridge

Part #	Description	List Price
8.697-133.0	Organic Vapor Respirator Set Cartridge	\$44.76

Disposable Caution Sign

Inexpensive way to show your customers their safety is your primary concern.



- An inexpensive way for carpet cleaners to help keep customers safe
- Because these signs are inexpensive, cleaners can leave them on the job to show customers they care about their safety
- 21" long, folds into an 11 x 6.5 wide triangle

Part #	Description	List Price
8.697-428.0	Disposable Caution Sign	\$1.45

Wands and Upholstery Tools



Dual-Jet Wand

12" head, 1100PSI, 60" length.



- 2-jet design uses standard 11002 T-jets
- Side splashguard helps to contain overspray
- Stainless-steel solution hose
- Full-flow vacuum extraction
- Precision nozzles for best performance

Part #	Description	List Price
8.697-192.0	Dual Jet Wand	\$269.10

Low-Profile Wand, 4-Jet

If you want your wands to utilize the full potential of your truck mount's blower to get the fastest drying time, then this is the wand for you.



- 4-jet design uses standard V-jets 95015
- Side splashguard helps to contain overspray
- Goodyear, 3000 PSI solution hose
- Full-flow vacuum extraction
- Precision nozzles for best performance
- 2" tube

Part #	Description	List Price
8.697-191.0	Low Profile Wand 4-Jet – 12"	\$372.73
8.697-202.0	Low Profile Wand 4-Jet – 14"	\$513.15

Gum Blaster

This 4" wonder tool does it all. Its double-bend design makes it an easy, comfortable wand to use.



- All Stainless-steel
- 800psi brass valve
- Closed-spray chamber
- Padded assist handle
- Stainless-steel solution line

Part #	Description	List Price
8.697-193.0	Gum Blaster	\$278.42

Super Glide Attachment 12"

Stainless-steel glide attachment with Teflon lips.



- Improves wand function
- Reduces the effort of pushing a wand

Part #	Description	List Price
8.697-199.0	Super Glide Attachment 12"	\$139.39

Detail Tool k-800 PSI Valve w-Whip Closed



- 4"-wide vacuum path
- Smooth head for improved suction
- Full-flow vacuum extraction
- Precision nozzles for best performance

Part #	Description	List Price
8.697-182.0	Detail Tool K-800PSI Valve w-Whip Closed	\$208.04

Padded Assist Handle



Part #	Description	List Price
8.697-188.0	Padded Assist Handle – 1.5"	\$64.27
8.697-190.0	Padded Assist Handle – 2"	\$37.36

Stair Wand 22" Straight

22" straight with 2" flair tube. This stair tool's design and its high-pressure water and steam enable you to remove ground-in dirt on stairs from a standing position.



- 2-jet design uses standard 11002 T-jets
- Side splashguard helps to contain overspray
- Stainless-steel solution hose
- Full-flow vacuum extraction
- Precision nozzles for best performance

Part #	Description	List Price
8.697-195.0	Stair Wand 22" Straight	\$238.51

Stair Wand 30" Straight

30" straight with 1.5" tube. This stair tool's design and its high-pressure water and steam enable you to remove ground-in dirt in stairs from a standing position.



- 2-jet design uses standard 11002 T-jets
- Side splashguard helps to contain overspray
- Stainless-steel solution hose
- Full-flow vacuum extraction
- Precision nozzles for best performance

Part #	Description	List Price
8.697-198.0	Stair Wand 30" Straight	\$238.51

Stair Wand 30" S-Bend Jet K 1.5" Straight

30" S-Bend with 1.5" tube, 1100PSI. The tool's design and its high-pressure water and steam enable you to remove ground-in dirt in stairs from a standing position.



- 2-jet design uses standard 9502 T-jets
- Side splashguard helps to contain overspray
- Stainless-steel solution hose
- Full-flow vacuum extraction
- Precision nozzles for best performance

Part #	Description	List Price
8.697-196.0	Stair Wand 30" S-Bend Jet K 1.5" Straight	\$238.51

Swivel-Head Ergonomic Stair Tool 30"

500PSI, open spray.



- 500 PSI, V2P brass valve
- Padded-assist handle
- Head swivels easily and stays in rotated position
- 1-jet brass Vee jet
- Perfect height for cleaning stairs

Part #	Description	List Price
8.697-200.0	Swivel-Head Ergonomic Stair Tool 30"	\$370.53

Upholstery Tool 4" – Closed



Precision nozzles for best performance.
Smooth 4" vacuum path head for improved suction.

- Tube diameter: 1.5"
- Head width: 4"
- Length: 10"
- Nozzles: 2503 or 2504
- Valve: K 105
- Pressure: 800 PSI
- Weight: 1.5 lbs
- Fill-low vacuum extraction

Part #	Description	List Price
8.697-186.0	Upholstery Tool 4" – Closed	\$159.01

Upholstery Tool 4" – Open



Precision nozzles for best performance.
Smooth 4" vacuum path head for improved suction.

- Tube diameter: 1.5"
- Head width: 4"
- Length: 10"
- Nozzles: 2503 or 2504
- Valve: K 105
- Pressure: 800 PSI
- Weight: 1.5 lbs
- Fill-flow vacuum extraction

Part #	Description	List Price
8.697-187.0	Upholstery Tool 4" – Open	\$92.89

Window Washing Tools

Window Washing Pill – 100/pk

The pill glass cleaner.



- New and improved formula!
- Pre-measured, individually packaged, mix with 2-1/2 gallons of water
- Biodegradable, skin-friendly and non-toxic

Part #	Description	List Price
8.697-034.0	Window Washing Pill 100/pk	\$107.38

Rub Out PT – 12/cs

Professional glass cleaner for removing hard water stains, rust, mineral deposits, lime scale and soap scum.



- Scrub stains without harming surface
- Super strength with a pleasant scent

Part #	Description	List Price
8.697-294.0	Rub Out PT 12/1 pint bottles	\$171.87

Easy-Glide Glass Cleaner QT – 6/cs

Liquid window cleaner.



- 100:1 concentrate. Makes 26 gallons
- Cleans windows with little effort, extreme glide
- Biodegradable, skin-friendly and non-toxic
- 6 quarts per case

Part #	Description	List Price
8.697-307.0	Easy Glide Glass Cleaner 6/1 quart bottles	\$185.85

Bucket Barge with Casters

Barge with swivel ball casters and bumper guards for Pro-Bucket.



- Features smooth-gliding swivel ball casters
- Bumper guards protect against splashes
- Holds on to bucket base, easily detaches

Part #	Description	List Price
8.697-325.0	Bucket Barge w/ Caster	\$105.32

Window Washing Bucket – 6 Gallon

Heavy-duty bucket with ergonomic handle for glass cleaning.
Accommodates 18" washers and squeegees.



- Heavy-duty, 6-gallon bucket with larger footprint for increased stability
- Easily fits 18" washer
- Rounded pour spouts on two corners make it easy to empty with more control
- Ergonomically-designed handle for comfort is stiffer and more stable for balance when carrying
- Use with optional snap-on lid and castors or bucket barge

Part #	Description	List Price
8.697-323.0	Window Washing Bucket 6 Gallon	\$40.68

Window Washing Bucket Lid

Sturdy snap-on lid for Pro-Bucket.



- New, sturdy lid snap-locks on to Pro-Bucket
- Inner seal helps prevent splashes and leakage
- Pull tabs on all four corners for easy removal
- Notched tabs lock handle into upright position when lid is in place.

Part #	Description	List Price
8.697-300.0	Window Washing Bucket Lid	\$26.64

ErgoTec Safety Scraper 1.5"

Sturdy snap-on lid for Pro-Bucket.



- Unique locking system eliminates blades from sliding out while working
- Uses standard No. 9 (1-1/2") razor blades (not included)
- Includes all the features of the SafetyScraper with the added comfort of the new ergonomic grip
- Rubber grip prevents scraper from slipping in hand which makes removing soil from surfaces even easier

Part #	Description	List Price
8.697-284.0	ErgoTec Safety Scraper 1.5"	\$4.80

Scraper ErgoTec 4"

High-tech solutions for today's fight against heavy dirt.



- Reversible, tempered 4" carbon-steel blade has blunt edge for cement or stucco work
- A razor edge for scraping paint and tape
- Handle easily attaches to all Unger poles
- Ergonomic grip — size: 4"/10cm

Part #	Description	List Price
8.697-310.0	Scraper ErgoTec 4"	\$36.60

Scraper Blades – 100 Blades/pk

Safety scraper replacement blades.

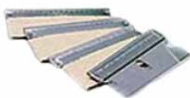

- Razor sharp No. 9 (1-1/2") standard blade for removing dirt
- Packed in a convenient reclosable plastic tray so blades are kept safe and dry to prevent rusting

Part #	Description	List Price
8.697-183.0	Scraper Blades – 100 Blades/pk	\$15.68

MicroStrip Washer Sleeve

MicroFiber replacement sleeve with scrub pad and velcro fastener.



- Superior cleaning power
- Can absorb up to six times its weight
- Scrub pad provides extra cleaning power
- Able to withstand frequent (500) washings

Part #	Description	List Price
8.697-312.0	MicroStrip Washer Sleeve – 14"	\$17.71
8.697-316.0	MicroStrip Washer Sleeve – 18"	\$43.73

Original Washer Sleeve

Plush, woven synthetic replacement sleeve with Velcro fastener.



- Gentle, but efficiently cleans
- Reinforced zigzag-stitched ends ensure long life
- Excellent for cleaning windows, screens and even dusting

Part #	Description	List Price
8.697-301.0	Original Washer Sleeve – 14"	\$26.90
8.697-318.0	Original Washer Sleeve – 18"	\$47.13

T-Bar ErgoTec®

Ergonomic T-bar with polypropylene handle.



- Features an ergonomic, two-component polypropylene handle for less strain and more control
- Water wells for high-water retention
- Attaches to poles with a press fit for out-of-reach cleaning

Part #	Description	List Price
8.697-293.0	T-Bar ErgoTec – 14"	\$9.68
8.697-296.0	T-Bar ErgoTec – 18"	\$22.82

S-Channel with Soft Squeegee

Stainless-steel "S" channel complete with ErgoTec soft replacement squeegee.



- Strong, long-lasting and rust-free stainless-steel construction
- Fits on ErgoTec, ProStainless-steel and GoldenPro squeegees
- Notched-channel system will not slip, wobble or bend

Part #	Description	List Price
8.697-290.0	S-Channel w/ Soft Squeegee – 18"	\$20.60
8.697-286.0	S-Channel w/ Soft Squeegee – 12"	\$17.04
8.697-285.0	S-Channel w/ Soft Squeegee – 6"/10 per pack	\$56.67

Squeegee Soft – 10/pk

Soft squeegee for window cleaning in reclosable blister pack.



- Ideal for colder temperatures
- Conforms to uneven surfaces
- Better glide with streak-free performance
- Longer lasting / superior packing
- Comes in 10/pk

Part #	Description	List Price
8.697-283.0	Squeegee Soft 10/pk – 18"	\$70.85
8.697-277.0	Squeegee Soft 10/pk – 12"	\$56.67
8.697-272.0	Squeegee Soft 10/pk – 6"	\$34.72

Squeegee Soft Promo – 25/pk

PromoPack soft rubbers in storage box.



- 12" soft rubbers in each pack, 25 packs
- Free box for storing rubbers and channels
- Reusable, adjustable UV-resistant plastic tube protects against dampness

Part #	Description	List Price
8.697-275.0	Squeegee Soft Promo 25/pk – 12"	\$141.80
8.697-281.0	Squeegee Soft Promo 25/pk – 18"	\$177.59

Squeegee Hard Promo – 25/pk

PromoPack hard rubbers.



- 18" rubbers in each pack, 25 packs
- Free box for storing rubbers and channels
- Reusable, adjustable UV-resistant plastic tube protects against dampness

Part #	Description	List Price
8.697-274.0	Squeegee Hard Promo 25/pk – 12"	\$141.80
8.697-280.0	Squeegee Hard Promo 25/pk – 18"	\$178.02

Squeegee Hard 6" – 10/pk

6" hard replacement rubber squeegee.



Part #	Description	List Price
8.697-271.0	Squeegee Hard 6" 10/pk	\$34.64

Squeegee Hard – 10/pk

ErgoTec hard replacement rubber.



- Ideal for warmer temperatures
- Optimum liquid removal on large, flat surfaces
- Coated with talcum to ensure freshness

Part #	Description	List Price
8.697-276.0	Squeegee Hard 10/pk – 12"	\$56.53

FIXI-Clamp

Plastic clamp for attaching tools like brushes, sponges, cloths and other tools.



- Made of fiberglass-reinforced nylon
- Innovative design quickly and easily grips sponges, rags, cloths, chamois and mop heads by simply tightening the locking collar
- Also holds the HANDI-BRUSH
- Combined with an Unger telescopic pole, the Fixi becomes a high-rise cleaning tool to solve many cleaning problems without climbing dangerous ladders
- Use with many types of cleaning solvents and liquids
- Attaches easily to all Unger Poles

Part #	Description	List Price
8.697-322.0	FIXI-Clamp	\$91.96

Standard Sponge



- Use dry to clean walls, vents, ceilings and for fire restoration
- Made of standard sponge material
- Locks in the jaws of the Fixi Clamp

Part #	Description	List Price
8.697-278.0	Standard Sponge	\$6.99

Telepole – Two Sections 8'

OptiLoc, telescopic pole, two sections with ErgoTec locking cone.



- The OptiLoc system is made up of drawn anodized aluminum in three different diameters
- Available in two and three sections with length ranging from 4' to 30'
- Secure external locking collar mechanism for fast height adjustment
- Size: 8'/2.50m

Part #	Description	List Price
8.697-324.0	Telepole – Two Sections 8'	\$91.01

Washer Holder Sieve

Bucket sieve.



- Features a chemical-resistant coating
- Wrings out up to a 18" washer sleeve
- Use with Pro Bucket

Part #	Description	List Price
8.697-317.0	Washer Holder Sieve	\$44.35

A

Accessories, Misc. 164

Accumulator

- by Interpump 77
- Pulse Dampener 77

Action Knife 154

Adapters

- Brass 34
- Steel 37

Admiral Pump Repair Kits 67

Air Filter / Regulators 135

Air King Pivoting High-Velocity 154

Air Scrubber

- Predator 1200 Portable 153
- Predator 600 Portable 153

Air Valve – Coil Blow Out 95

AMP and Voltmeters 96

Aqua Master™ Model 440 141

Aquatec 550 Series Diaphragm Pump 143

Aviation Snips for Most Metals 154

B

Baldor Motor

- C-Face Open Drip Proof (ODP) 100
- Open Drip Proof (ODP) 99
- Totally Enclosed Fan Cooled (TEFC) 100, 101

Ball Valve

- 3-Way 93
- 800 PSI, Stainless-Steel, One-Piece 92
- 2000 PSI, Stainless-Steel 92
- 5800 PSI, Stainless-Steel, High-Pressure 92
- Brass Mini 92
- Compact PVC 93
- Forged-Brass 92
- High-Pressure 92
- Mini 92
- Nickel-Plated Brass 92
- Polypropylene 93
- PVC 93

Banded Coupling 38

Base Molding and Tackstrip Lifter 155

Base Plates for Ignitors 108

Battery Boxes with Cover, Marine Style 122

Bay Accessories, Stainless-Steel 136

Beckett

- Misc. Parts 105
- Tune-Up Kit 107

Blower Wheels 106, 107

Blue

- Top Filter 41
- Tuff-Flex 1-Wire 4000 PSI Hose – 3/8" 22
- Tuff-Flex 2-Wire 6000 PSI Hose – 3/8" 22

Bonnet Carpet 165

Boot Hazmat / Flood 165

Booty Boots 165

Bracket Sockets 27

Briggs & Stratton

- Engines – Gasoline 97
- Engine Parts 97

Broad Spray Stainless-Steel Nozzles 47

Brushes

- Brushes 131
- Brass Velvet 162
- Large Horsehair 162
- Nap 163
- Swivel Grout 162

Bucket

- 10-Quart 164
- Barge with Casters 169

Burner

- Ignitors 108
- Motors 107
- Transformers 108

Bushings – Brass 34

C

Cam Switch and Box, 60 AMP On/Off 117

Cam Switches

- 3-Position, “Big Boot” 117
- 3-Position, Machine Control 117

– Cam Switch, On/Off	118	Clear Bowl Filters	39
Carpet		Clear Bowl Fuel Filter	41
– Gripper	155	Clear PVC Tubing	24
– Installation and Repair	154	Clear Reinforced PVC Tubing	24
– Repair Kit	155	Cold Weather Garden Hose	24
– Repair Replacement Blades	155	Comet Pumps and Pump Kits	75
– Shears Bent Handle	155	Common Parts – Beckett & Wayne	106
– Wall Trimmer	155	Complete Pump Extraction Kit	77
Carry-All Tray	165	Complete Seal Kits	60
Carry-All Tray Inserts	165	Complete Wheels	122
Car Wash		Compound, Anti-Seize	78
– Booms, “Reflex”	136	Connector	
– Vacuum Hose, CW150 and CW200	137	– 1.5" Stainless-Steel	158
Caution Sign, Disposable	167	– 1.5"-2" Stainless-Steel	158
Ceramic Plungers	76	– 2" Stainless-Steel	158
Ceramic Plunger Kits	60	– 2" Stainless-Steel ‘Y’ Vac	158
Ceramic Unitized Ball Valve	11	– Barb Hose 1.5"-1.5"	158
Chalk		– Barb Hose 2"-1.5"	158
– Reel	157	– Barb Hose 2"-2"	158
– White	157	– for Cable, Wire and Tubing, Liquid-Tight Strain Relief	120
Check/Foot Valve	40	Connector Hose	
Check Hose Barbs	35	– 2'-10'	25
Check Valves		– Connector Hose / Car Wash Bay Hose – 12'-25'	25, 138
– 1200 PSI	91	Containers	163
– Backflow Preventor	91	Control Set “W” Series / Integrated Regulator / Unloader	83
– High-Pressure	91	Cool-Wrap Wand	165
– Nylon, Diaphragm	146	Copper and Plastic Float Balls	90
– PVC	91	Cord Caps / Plugs	119
– Spring-Loaded, Brass	91	Cord Hugger 3 x 12	160
– Stainless-Steel	91	Corrosion-Resistant ABS Gauge	95
– Swing Action	91	Couplers	
Chemical Filter, Brass	5, 38	– 1/4" Female	158
Chemical Injectors		– 1/4" Female, Secure Lock	158
– 400 Series	89	– 1/4" Female Stainless-Steel	158
– ST-60	88	– 1/4" Male Quick-Connect Econo	159
– ST-62 Variable	88	– 1/4" Male Quick Connect PH	159
Chemical Line w/ Filter	38	– 1/4" Male Stainless-Steel	159
Chemical Metering Valve, ST-61	88	– Built by Browning or Lovejoy	102
Chemical Sprayer, Industrial	144	– Quick Connect 1/4" F Econo	159
Circuit Breakers	116	Coxreels Hose Reels	28
CleanCut Fuel Pump	107	Crimp Fittings	24

Cross – 4 Connects 37
 Cushion Back Cutter 155

D

Data Log Temperature and Humidity Kit 150
 Delavan Fuel Nozzles 110
 Detail Tool k-800 PSI Valve w-Whip Closed 168
 Diaphragm
 – Float Valve 90
 – Kits for Yamada Pumps 134
 Digital Monitor 118
 Dirt Killer Rotating Nozzle 49
 Door Hinge Pin Remover 155
 Double Nozzle Head 53
 Double Shut-Off Couplers and Plugs 31
 Drain Cocks 36
 D-Ring Handi Tie 1.5 160
 Drum Pump 164
 Drum / Tank Pump – Crank Type 131
 Drum Tool Accessories 130
 Dual-Chemical Systems 129
 Dual Lances 14
 Dual Trigger Lance 15
 Duckbill Napping Shears 155
 Dump Gun 13
 Duo-Reg Nozzle 52
 Dust Mask 166

E

Easy-Glide Glass Cleaner QT – 6/cs 169
 Easy-Start Valve 95
 EATON Cutler-Hammer DP Contactors 114
 Elbows
 – 90° 38
 – 90°, Brass 34
 – Steel 37
 Electric Glue Gun 156
 Electrode / Insulator Assembly 104

Enclosure Box for Magnetic Motor Starter Sets 116
 Equipment 148
 Exact-A-Flow Pressure Reducer / Injector 89
 ExStik pH Meter, Waterproof 151
 Exttech pH Meter Buffer Solution 151
 Extended Twist Seal Coupler 19
 Extruded or Forged Tees – Brass 35
 EZ Fill Container 163
 EZ Moves
 – 4' Furniture Slide 157
 – Hard Surface Pro 157
 – Pro 157

F

Fast Lock Edge Sealer 156
 Faucet Kit Adapter 161
 Female Crosses – Brass Extruded 35
 Fiberglass “Super Handles” 131
 Fiberglass Telescoping Wands 17
 “Field” Attachable Couplings 24
 Filter
 – Carbon, Vapor Lock 152
 – Second-Stage Particulate 152
 Fittings
 – Brass Bulkhead / Tank 146
 – Bulkhead 146
 – Plastic 146
 FIXI-Clamp 171
 Flanges 79
 Flex Couplers 79
 Flex Couplings 104
 Flex Lances 18
 Flex Line Bypass / Supply Line Hose 24
 Float
 – Adjustable, Bronze 90
 – Assembly, Brass 90
 – Ball and Stem, Brass 90
 – Stainless-Steel 121
 Flow-Actuated Unloaders 85
 Flow Control Metering Valve 6, 93

Flow Meters	94
Flow Selector Valve	93
Flow Switch	112
Flow Switch, 7300 PSI, Stainless-Steel	112
Flow-Thru Gun	13
Foam Brush and Accessories	135
Foam Cannon	54, 132
Foamer, Compact	132
Foamer with Tank, Adjustable	132
Foam Jet Kit	132
Foam Kit, Lafferty Airless	132
Foam Nozzle Attachment	147
Fuel Caps	122
Fuel Conditioner and Soot Remover	107
Fuel Filters	41
Fuel Filter / Water Separator	6, 41
Fuel Nozzle Check Valve, "Snap"	110
Fuel Oil Pressure Gauge	95
Fuel Pumps	107
Fuel Solenoid Valve, 12V DC KIP	108
Fuel Tanks	121
Fuel Tank, Diesel 9-Gallon	121
Fuses	116, 136

G

Galvanized Pipe Fittings	38
Garden Hose	
– Apex Quality	23
– Garden Hose Fittings	36
Gas Burner Rings – N/G or L/P Gas Jets	109
Gas Valves	
– Accessory Components	111
– by Robert Shaw, 1"	111
– LP or Natural	111
Geared Reduction	78
Geared Reduction Units Interpump / General	78
General Fuel Filter Element	41
General Pump Nozzles	45
Genisys™ Controller and Contractor Tool	104

Genuine Interpump / General Pump Kits	72
GFCI Module 20 Amp – 120V or 240V	120
Giant Trigger Guns	10
Gloves	
– Disposable Nitrile	166
– Industrial Duty	133
– Nitrile Flock-Lined	166
– Vinyl Disposable	166
Glue Sticks – 30/pk	156
Goff's Curtain Walls	127
Grandi	
– Brush	162
– Brush (Head Only)	163
– Groom	163
– Groom Conversion	163
– Groom (Head Only)	163
Green-Cap In-Line Filter	39
Groomers	162, 163
Ground Fault Circuit Interrupters (GFCI)	120
Gum Blaster	168
Guns	
– Big	12
– Dump, AP	13
– Open, AP1000	13
– Swivel	32
– Trigger, AP	8, 10
Gutter Cleaner Attachment	17
Gymatic Unloaders	85

H

Handi	
– Brush	163
– Groom Brush	163
Handle, Padded Assist	168
Hansen Quick Connective Couplers	30
Heavy-Duty In-Line Filters	39
HEPA Filter PRED 1200	153
Hex Couplings	
– Brass	34
– Steel	37

Hex Double Nipple – Brass	34	Humidity Temperature Pen	150
Hex Nipple – Steel	37	Hypro-Style Unloader	84
Hex Head Plugs	36		
Hex Pipe Plugs – Steel	37	J	
Hex Reducing Nipple – Brass	34	Indicator Lights	118
Hex Socket Head Plugs	36	Injector	
High / Low Variable Angle Nozzle, HL250	52	– Amerimax	87
High-Pressure Nozzle Filters	53	– Brass	89
High-Volume Filter and Parts	40	In-Line	
High-Volume Unloader, VB200 / 150	82	– Can-Type Filters and Parts	39
Hi-Lo Injector	88	– ClearView Filter	40
HM Regulator / Unloader	83	– Filter, All Metal	39
Hobby Gun, Lance and Hose	18	– High-Pressure Nozzle Filters	40
Hobby Hose	23	Installer's Carpet Kicker	156
Honda Engine Parts	97	Insulation and Rigid Disc / Donuts	111
Honeywell Gas Valves	109	Interchangeable Orifice – Fits Nozzles Above	52
Hose Barbs – Brass	35	Inter-Lube-Red Gear Lube	77
Hose Bend Restrictors	23	Interpump	
Hose Buddy	160	– General Pumps	68, 69, 70
Hose Clamps	36	– General Pump Kit Selection Chart	71
Hose Cuffs		– Packing Extractor Tool	77
– 1.5"-2" Small End Threaded	159		
– 2" Swivel Reducer	159	J	
– 2"-1.5" Both Ends Threaded	159	J.E. Adams Gun	10
– Accessories, Misc.	159	Jetter Pulse Valves	76
Hose Hook 1.5	159	JIC Nipples – Brass	35
Hose Huggers		JIC Swivels	34
– 3 x 27	159	JIC x Pipe Nipples	34
– 3 x 34	159	Junction Boxes	115
Hose Reels			
– AP	9, 28	K	
– Cart System	7, 26	Kerick Float Valve	91
– Guide	7, 26	Kew Replacement Accessories	18
– Riser	7, 26	Keyed Ignition Switch – 12V DC	98
– Stackable, Legacy	7, 26	Knee Pads	166
– Stand	162	Kohler Lombardini Engines	
– Stand, Double	162	– Diesel	98
Hoses, Connectors and Accessories	159	– Parts	98
Hour Meters for Gasoline Engines	96		
Hudson Float Valve	91		

Kool Top Seaming Iron 156
 “K” Series Pressure Regulators 83
 “K” Series Pressure Regulators Kits 83

L

Lances and Side Handles, Big, Stainless-Steel 16
 Lance Handles / Accessories 16
 Lance Nozzle Couplers 49
 Lances, Flex 137
 Legacy
 – 1-Wire Custom Hose Fittings 21
 – 2-Wire Custom Hose Fittings 21
 – 3/8" Gray Hose – Wrapped 21
 – 4/pk and 5/pk Color-Coded QC Nozzle Kits 4, 44
 – Air Mover (LAM3) 154
 – “Best” Spray Gun 2, 10
 – Burners, Fire-Rite 105
 – Compact Foamer 5, 54
 – Flow Switch 6, 108
 – Jetter Pulse Valves 76
 – Pump Repair Tool Kit 65
 Legacy HD Pumps
 – Belt Drive Units 6, 55, 56
 – Cross Reference / Comparison Chart 62
 – Direct Drive Units 5, 56, 57
 – HD Pumps 55, 56, 57
 – Repair Kit Selection Chart 58, 59
 Legacy Hose
 – Reels 7, 26, 27
 – Reels, Stackable 7, 26
 – Reel Swivels 27
 Legacy Individual 1/4" QC Nozzles 4, 44
 Legacy “Industrial” Spray Gun 2, 10
 Legacy Oval Molded Grip Lances 14
 Legacy Pumps
 – Belt Drive Units 63, 64
 – Direct Drive Units 64, 65
 – Pumps 73
 – Repair Kit Selection Chart 65
 – Repair Tool Kit 65
 Legacy Quick Couplers 3

Legacy Rawhide
 – 1-Wire 3000 PSI Smooth Non-Marking Hose 20
 – 1-Wire 4000 PSI Black Hose 2, 20
 – 2-Wire 3/8" Hose 2, 20
 – Hoses 20
 – Smooth Cover Black Hose 20
 Legacy Revolution Turbo Nozzle 4, 42
 Legacy Square Molded Grip Lances 14
 Legacy Stackable Hose Reels 26
 Legacy Superlite Stainless-Steel Dual Lance 2, 13
 Legacy Ultima
 – 1-Wire Black Hose (wrapped) 21
 – 2-Wire 5000 PSI Black Hose 2
 – 2-Wire Black Hose (wrapped) 21
 – Hoses 21
 Legacy Undercarriage Cleaner 123
 Legacy Universal Unloader (UU1) 6, 80
 Legacy Vented Lances 15
 Lift Buddy 165
 Locks for Meter Boxes 136
 Loop Pile Cutter 155
 LP Conversion Kit for Robert Shaw 111

M

M407 Trigger Gun 10
 Male Branch Tees – Brass 35
 Manual Motor Starter w/ Sealed Box 116
 Maxshield Coveralls with Hood and Boots 166
 Measuring Cups 163
 Measuring Cups – 2 oz 163
 Measuring Wheel 166
 Mecline AL 35 Gun 12
 Merchant Coupling 38
 Meter and Selection Valve, ST-66, Chemical 94
 Metering / On-Off Valve, Chemical 94
 Metering Valves
 – Brass 93
 – Chemical 94
 Miscellaneous Parts 122
 Moisture Sensor, Hydro Shark 152

Molded Plastic Float Tanks 121

Mosmatic Gun Swivel 125

Mosmatic

- Roof Cleaner 126
- Surface Cleaners and Duct Cleaner 125

Multi-Fan Nozzle 52

MV

- Hi-Lo Turbo Nozzle 49
- Hobby Wash Gun 12
- Lance Handle 16
- Triple-Function Nozzle 49

N

Nipples – Brass 34

Non-Pivot Reel Brackets 27

Nozzles

- Accessories 108
- Adjustable 8, 53
- Adjustable, ST-51N 53
- Fan Selection 43
- for Low-Pressure Applications, Brass 47
- Holder, Adjustable 17
- Holder Grommet 45
- Protector / Coupler 54
- Size Selection Chart 43

O

Oil Burners

- Oil Burners 106
- 115V / 230V 105
- 14V ADC 105

Oil-Fired Hot Box 5, 126

Oil Solenoid Valve 109

Open Guns 13

Orange 600 Sprayer Hose and Ribbed PVC Sprayer Hose 23

Orificed Hose Barb 36

O-Rings 29

O-Ring Tool 77

Ozone Generator Villa 1000 152

P

Packing and Seal Kits 76

Packing Extractor 77

PA

- Float Valve 90
- Trigger Gun 12

Perfect Patch 158

Performance Tables 142

Phoenix Flow Switch w/ Pilot 112

Pipe Nipple – Zinc 38

Pipe Street Elbows 38

Pipe Tees 38

Pipe Thread Hex Nuts 36

Piston Pumps 76

Plastic Chemical Strainer 38

Plunger Oil Seal Kits 60

Pocket Reference – Third Edition, Amazing 133

Power Stretcher 156

Pre-Filter, Fiber Trapper 152

Pressure-Actuated Unloaders 85

Pressure-Actuated Unloaders, 13 GPM 85

Pressure and Temperature Test Set 96

Pressure Gauges 95

Pressure Gauges, Stainless-Steel 96

Pressure Loop 2-Wire – 1/4", 3/8" and 1/2" 22

Pressure Regulators

- Automatic 81
- Brass 145
- Low-Flow Brass 145
- Nylon 145

Pressure Switches

- Black 113
- Compact 112
- Pressure Switches 6, 112
- Red 113

Pressure Valve, Foot-Controlled 130

Pressure Washer

- Accessory Kit 19
- Motors, A.O. Smith 101

Pressurized Drying System-21 154

Profit From Power Washing	133
Proportioners	141
Protector Pads – 1000/cs, Plastic	166
Psychrometer, Precision	151
PTO Geared Multiplier	78
Pulley Bushings	103
Pulleys	102, 103
Pulsar Unloaders	81
Pulse Hose	23
Pump	
– Air-Operated	135
– Diaphragm, Flojet	143
– Diaphragm, Aquatec 550 Series	143
– Kits, AR	75
– Lube	77
– Oil, Legacy	77
– Out Shield	152
– Parts and Tools	76
– Rails	60
– Repair Kit Selection Chart, AR	74
– Repair Tool Kit, Legacy	65
– Selection Chart for Legacy HD Belt Drive Units	61
– Selection Chart for Legacy HD Direct Drive Pumps	60
– Technical Information	79
– Triplex Ceramic Plunger, AR	73
– Units, Diaphragm	143
– Valve Kits	60
Push Button and Contact Blocks	114
Push-N-Lock Barbs	35

Q

QC Nozzle Sets 4/pk and 5/pk Color-Coded	45
QD Connector Sleeve Set	160
Quick-Connect Injector, Adjustable	89
Quick-Coupled Amerimax	87
Quick Couplers	
– 11,000 PSI	30
– Brass	8, 31
– Quick Couplers	29
– Stainless-Steel	3, 29

R

Racor Filter Funnel	41
Rain Suit – 2-Piece	133
RainTite Switch Box	116
Reducing Bushing – Steel	37
Reducing Hex Couplings – Brass	34
Reference / Calculation Guide, GPM and RPM	102
Regulating Relief Valves	
– Regulating Relief Valve	87
– ST-230	84
– ST-230	84
– VS 220	86
– VS 350	86
– VS 500 High-Pressure	86
Regulator, VS 200 / 180, High-Volume	86
Regulator / Unloader	
– Regulators / Unloaders	81
– ST-261	84
– ST-280	84
– VB7	81
– VB85 / 820	82
– VB130	82
– VRS3	81
Relays	116
Replacement Accessories	19
Replacement Disks, Instant Hold	157
Respirators	
– Full-Face	167
– Half-Face – Large	167
– Set Cartridge, Organic Vapor	167
Restoration Equipment and Accessories	150
Robokim	
– Chemical Injectors	88
– Quick-Coupled Chemical Injectors	88
Rocker Switches	118
Roller Pumps, Hypro	142
Rollover Nozzle Head, ST-56	53
Rollover Nozzle – Twist-Type	53
Romex Connectors (Metal)	120
Rosebud Nozzle Guard	48

Rotary Switch, 8-Position	136	Slip-on Nozzle Protector	54
Rotojet		Sludge Sucker, ST-36 Pit Boss	130
– 2000	49	Small Engine Test Equipment	102
– 3700 / Rotojet 5800	50	Smoke Tester – Diagnostic Tool	108
– Soft, Hard Rotating Nozzle	49	Smooth Action Roller	156
Rotomax Rotating Nozzle 3500 and 5800 PSI	49	Snap N Lock	
Rotovac WideTrack.	148	– Cuff	160
Rub Out PT – 12/cs	169	– Cuff 2"	160
Rupture Disks	95	Soap Nozzles	48
S		Soft-Edge and Hard-Edge Nozzle Protector	48
Safety Glasses		Solenoids	
– Amber	166	– Kip	140
– Clear	166	– Starter, 12V DC	98
– Splash-Proof	167	– with Built-In Strainer	140
Safety Items	165	Solution Hose	
Safety Pressure Relief Valves	86, 95	– 50', 1/4" 1500 PSI	161
S-Channel with Soft Squeegee	170	– 50', 1/4" 3000 PSI	160
Scraper Blades – 100 Blades/pk.	170	– 50', 3/8" Blue, 3000 PSI	161
Scrapers		– Reel	160
– ErgoTec 4"	170	Sonin	
– Safety, 1.5", ErgoTec	170	– 4-in-1 Multifunction Detector	151
Sandblast Kit – Carbide Nozzle Industrial Grade	128	– Digital Moisture Meter	151
Sandblast Head, Professional	127	– Laser Targeting Range Finder	151
Sandblast Nozzles Tips	128	– Moisture Test Meter	151
Seal Kits	60	– Multi-Measure 45	151
Seam-Mate Iron Box	156	– Water Alarm with Remote Sensor	151
Seam Roller by Action	156	Speedmaster Throttle Control	96
Self Serve Underbody Wand Assembly, Suttner	126	Spigot for 5 Gallon	164
Series 505 Stainless-Steel	89	Spinner Tools	
Sewer Hose	23, 130	– Hand	149
Sewer Nozzles, Stainless-Steel	8, 54, 129	– Hard-Surface	149
Sewer / Tube Cleaning Nozzles	54, 129	– with 10' Hose, Hand	149
Shelving, Stainless-Steel	149	Sponge, Standard	172
Shipping Tape and Dispenser	133	Spot Spray Gun Assembly, 910	144
Shoe Covers		Spot Spray Pump, Twin-Diaphragm	142
– Blue	166	Spotting Bottle	164
– White	166	Sprayers	
Siphon Pumps	141	– Air-Power	132
		– Chemical-Resistant	147
		– Industrial Stainless-Steel	147
		– Parts	147

- Poly-Molded 147
- Professional Stainless-Steel 147
- Stainless-Steel 147
- Spray-Flex™ Flex Wand 18
- Spray Lances
 - Trigger-Control 144
 - Trigger-Jet 145
- Sprayermaster
 - Adjustable 147
 - High-Pressure 148
 - Standard 148
- Spraymax Trigger Gun 144
- Spraying Systems Nozzles 46, 47
- Squeegees
 - Hard 6" – 10/pk 171
 - Hard – 10/pk 171
 - Hard Promo – 25/pk 171
 - Soft – 10/pk 170
 - Soft Promo – 25/pk 170
- Stack Bracket 162
- Stair Tools
 - 30", Swivel-Head Ergonomic 170
 - Cushion-Handle 157
 - T-Handle 157
- Steam Nozzle 53
- Steam Valve 94
- Stems Only 90
- Step-Down Transformers 115
- Sticky Tabs 164
- Straight Edge, Aluminum 155
- Strainmaster 164
- Street Elbows
 - Brass 35
 - Street Elbow – Steel 37
- Street Tees
 - Brass 35
 - Steel 37
- Styrofoam Blocks
 - Blue 164
 - White 164
- Suction Foot Valve, ST35 / 35R 40

- Surface Cleaners
 - A+ 9, 124
 - Nozzle Selection Chart 9, 123
 - SideWinder 125
 - Whisper Wash Flat 124
- Super Glide Attachment 12" 168
- Suttner
 - Dual Lances 15
 - Flow Switch 112
 - Push and Pull Lance 16
 - Self Serve Underbody Wand Assembly 126
 - Trigger Guns 11
 - Turbo Nozzles 51
- Switches
 - High-Limit 113
 - with Wire Lead, High-Limit 113
- Swivel
 - 90° 32
 - Assembly 162
 - Assembly, Solution Hose Live 149
 - Ball Bearing 33
 - Cuff: Big End Threaded 159
 - Cuff, Hide-A-Hose 159
 - Heavy-Duty 145
 - High-Pressure, Stainless-Steel, and Economy – Brass 32
 - Hose Barbs – Low Pressure 36
 - Low-Pressure 136
 - Medium-Pressure 136
 - Repair Kits 28
 - Right Angle 32
 - Stainless-Steel 9, 33
 - Stainless-Steel Ball Bearing 33
 - Swivels 33

T

- Tandem Hose Clamp 160
- Tank Screen / Strainer 40
- T-Bar ErgoTec® 170
- Tee – 3 Connects. 37
- Teflon® Thread Sealing Tape 133
- Telepole – Two Sections 8' 171

Temperature Gauges 96

The Big One 38

Thermo-Anemometer, Mini 151

Thermometer

- Hygro and InfraRed 150
- IR Laser 150

Thermostat

- Adjustable 119
- Adjustable Flow-Thru 119
- Brass In-line 119

Thermal Relief Valve

- Compact 94
- Thermal Relief Valves 94

Thread Lock Products 133

Tile and Hard Surface Tools 149

Timax Pressure Regulator Valve 86

Timer 116

Tip-Jet

- Nozzle System 19
- Nozzle System – Tips and Components 48

Tip – Stainless-Steel, 15 x 1 Long Range 145

Tip Retainer 19

Toggle / Push Button Switch 114

Toggle Switch, 30 AMP 114

Tool Pocket, Swivel 157

Transformers 136

Trigger Sprayer

- Chemical-Resistant 147
- Ergonomic 147
- Ultra-Spray 147

Truck-Mount Hose

- Heavy-Duty Blue 161
- Heavy-Duty Gray 161
- Vacuum 161

Turbine Series Guns 145

Turbo Nozzles 8, 50, 51

Twist Seal Couplers 31

U

Undercarriage Cleaner 5, 126

Uninsulated Lances 16

Unloader

- MG4000 Series 86
- Mounting Block 87
- Bolt-On, AR 85
- VB80 / 400, Stainless-Steel 82
- VB350 / 4 82
- Valves, VRT100 81
- Valves, VRT3 81
- Valves for Legacy HD Pumps, VBA35 / VB55 81

Universal “Elektra” 117

Upholstery Tool

- 4", Closed 169
- 4", Open 169

Up Stream Injector, ST-64 89

Utility Gauges, Steel 96

UV Flashlight

- 32 LED Blaze 150
- 51 LED Blaze 150
- 128 LED Blaze 150

V

Vacuum

- Accessories 137
- Hose Reel 161
- Hose Shelf Hook 161
- Motors, Ametek-Lamb 138
- Motors, AP 138

Vac Switch – Burner Control 112

Valve

- 1/4", Ball Shut-Off 158
- Chrome Ball 158
- Erie Motortrol® 140
- Premium Ball Shut-Off 158
- Solenoid 139, 140
- Replacement / Repair Kits, Solenoid Valves 140
- Specifications, Solenoid Valves 139
- Trigger 144
- Unloader, Automatic Pressure Compensating, VB10 / VB9 82

Van Accessories 149

Variable Angle Nozzle	53
VB75 / VB135	82
V-Belts, Super "Gripnotch"	103
Vertical Float Tank Valve	90
Vinyl Electrical Tape	119
Viper Rotating Nozzle	49
Voltmaster Generator	118
V-Packing Insertion Tool Kit.	77

W

Wall Buddy	164
Wand	
– 4-Jet, Low-Profile	168
– Dual-Jet	167
– Hook, Vinyl-Coated	162
– Upholstery Tools	169
– Stair, 22" Straight	168
– Stair, 30" S-Bend Jet K 1.5" Straight	168
– Stair, 30" Straight	168
Washer Holder Sieve	171
Washer Sleeve	
– MicroStrip	170
– Original	170
Wash Gun, RB65	134
Water Broom, 16"	9, 127
Wayne Burner Parts	106
Whitewater® Combination Steam Hose	22
Winco AC Generator	117
Window Washing	
– Bucket – 6 Gallon	169
– Bucket Lid.	169
– Pill – 100/pk	169
– Tools.	169
Wire Loom – For Wiring Harnesses	120

X

X-Jet Long Range Nozzle	16
XT Overloads for DP Contactors	114

Y

Yamada Pumps	134
Y-Trap Strainer	40
YU – High-Volume Unloader	85

Z

Zinc-plated Heavy Wall Steel Pipe Fittings	37
ZipWall	
– 12' Poles – 2/pk	153
– 4/pk Plus	153
– Carrier Bag	153
– Foam Rails and T-Clips	153
– GripDisks – 2/pk	153
– Kit 20	153
– Side Clamp – 2/pk	153
– Zipper	153

Buy with Confidence!

Landa Kärcher Group's advertised specifications (PSI, GPM, etc.) are certified by the Cleaning Equipment Trade Association to be correct. And, of course, nearly all Landa Kärcher Group equipment is ETL certified to UL-1776 and CSA safety standards.



Certification

Our manufacturing facilities have established and apply a Quality and Environmental Management System to be ISO 9001:2008 and ISO 14001:2004 certified.



 Landa.com

 facebook.com/Landa.Karcher.Group

 youtube.com/c/LandaTV